



THIELE Lifting Products

Grade 80



Product Overview **THIELE** Lifting Products Grade 80

TWN 0805



Page
70

Round Steel Link Chains

TWN 0795



TWN 0797



TWN 0803



TWN 0810/1



TWN 0810/2



TWN 0810/4



TWN 0811/1



TWN 0811/2



TWN 0811/4



TWN 0815



TWN 0816



TWN 0817



TWN 0820



TWN 1313



TWN 1314



TWN 1315



Page
71-78

Suspension Components















TWN 1320



Page
78

THI-LOK® Connector



TWN 0798	TWN 0799	TWN 1340/1	TWN 0854	TWN 0855
				
TWN 0855/1	TWN 0856	TWN 0858/1	TWN 0859	TWN 0860
				
TWN 0868	TWN 0872	TWN 0873	TWN 0887	TWN 0889
				

Page 79-84

Hooks





TWN 0827	TWN 0827/1	TWN 0851	TWN 0896	
				

Page 85-86

Shortening Components





	TWN 0861 	TWN 0862 	TWN 0870 	TWN 0871 	TWN 0897 
	TWN 0898 	TWN 0898/1 			
Page 87-88	Shackles				

	TWN 1450 	TWN 1451 	TWN 1452 		
Page 89	Chain Tensioners				

	TWN 0812 	TWN 0845 	TWN 0869 	TWN 0869/1 	TWN 0875 
	TWN 0882 	TWN 0892 	TWN 0893 	TWN 0894 	TWN 0895 
Page 90-94	Special Components and Chains				



<p>TWN 1400</p> 	<p>TWN 1401</p> 
<p>TWN 0601</p> 	

Page 95-96

Special Components and Chains





<p>TWN 0904/0</p> 	<p>TWN 0905/0906</p> 	<p>TWN 0920-0922</p> 	<p>TWN 1920</p> 	<p>TWN 1920</p> 
<p>TWN 0930-0932</p> 	<p>TWN 0950-0952</p> 	<p>TWN 0962</p> 	<p>TWN 0967/0</p> 	<p>TWN 0967/1</p> 
<p>TWN 0968</p> 	<p>TWN 0969</p> 	<p>TWN 1908/5</p> 	<p>TWN 0940</p> 	<p>TWN 0941</p> 
<p>TWN 0944</p> 	<p>TWN 0945</p> 	<p>TWN 0946</p> 	<p>TWN 1402</p> 	





Page 97-103

Spare Parts and Accessories



<p>Page 105</p>	<p>Form K11</p> 	<p>Form K12</p> 	<p>Form K22</p> 	
	<p>Endless Chains</p>			

<p>Page 107</p>	<p>TWN 0449</p> 	<p>TWN 0536</p> 	<p>TWN 0710/1</p> 	
	<p>Lashing Chains</p>			

<p>Page 110</p>	<p>TWN 0797</p> 	<p>TWN 0803</p> 	<p>TWN 0805</p> 	<p>TWN 0871</p> 	
	<p>Offshore Chain Slings</p>				



Selection Criteria for Chain Slings

1. Determine the **weight of the load** to be lifted.
2. Check **number of chain-legs** required (depending on the numbers of existing lifting points).
3. Determine the **trade size** by taking the **inclination angle** into consideration
(see table 1 on page 67, table 2 on page 68 and table 3 on page 69).
4. Consider possible (extreme) **temperature influences** (see table 4 on page 70).
5. Consider that **asymmetry** may influence the load factor (see table 5 on page 70).
6. Choose the **master links**, **shortening elements** and **components** suitable for the selected chain trade size.
7. Determine the **chain length** by considering the total effective reach.
8. Control (inspect) selected components and/or in-use chain slings to ensure that they meet or exceed all available industry and government safety-laws and regulations (acc. to DGUV).



Special Advices:

Please also consider more complicated conditions of use, such as intermittent impacts or loads when selecting the slings and/or components. Grade 80 chain slings and components are not allowed to be used over 400°C temperature. If the slings were used above a temperature of 400°C, then they have to be immediately be rejected. Please contact the manufacturer. The THIELE assembly system must not be used in the case of chemical influences such as acids and/or lyes.

THIELE Plant Standard (TWN)

THIELE plant standard fulfills the requirements of the EG-directive for machines, particularly for the safety relevant components. The working load limit and the test requirements meet or exceed the European standards.



Identification Tag

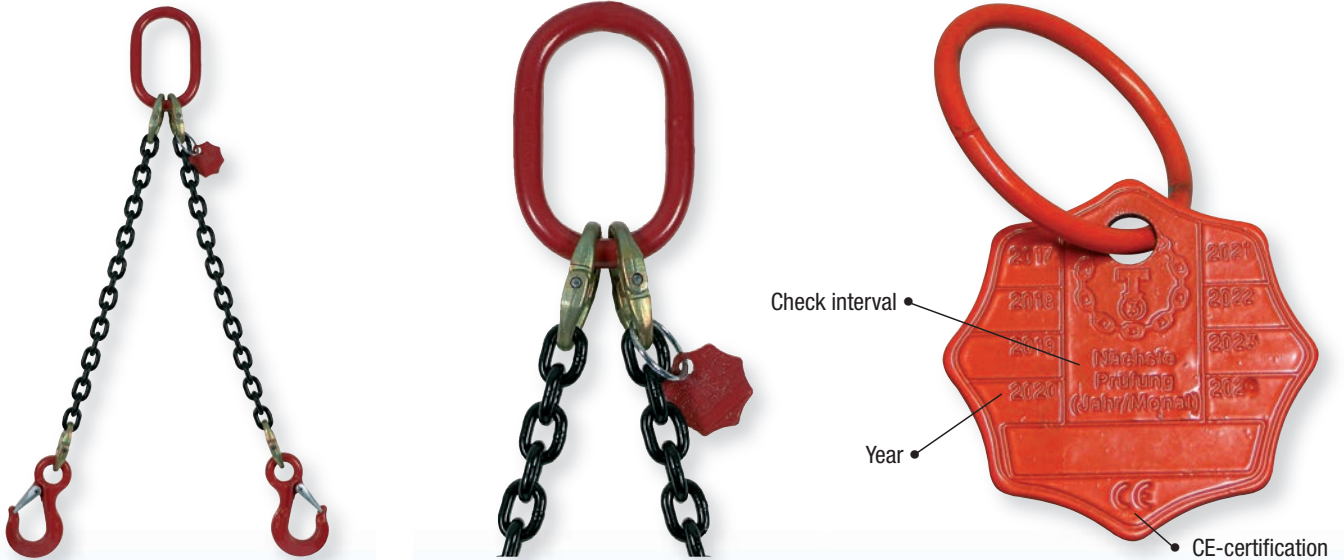

The identification tag according to DIN EN 818-4 for chain slings Grade 80 has an octagonal shape for easy identification.

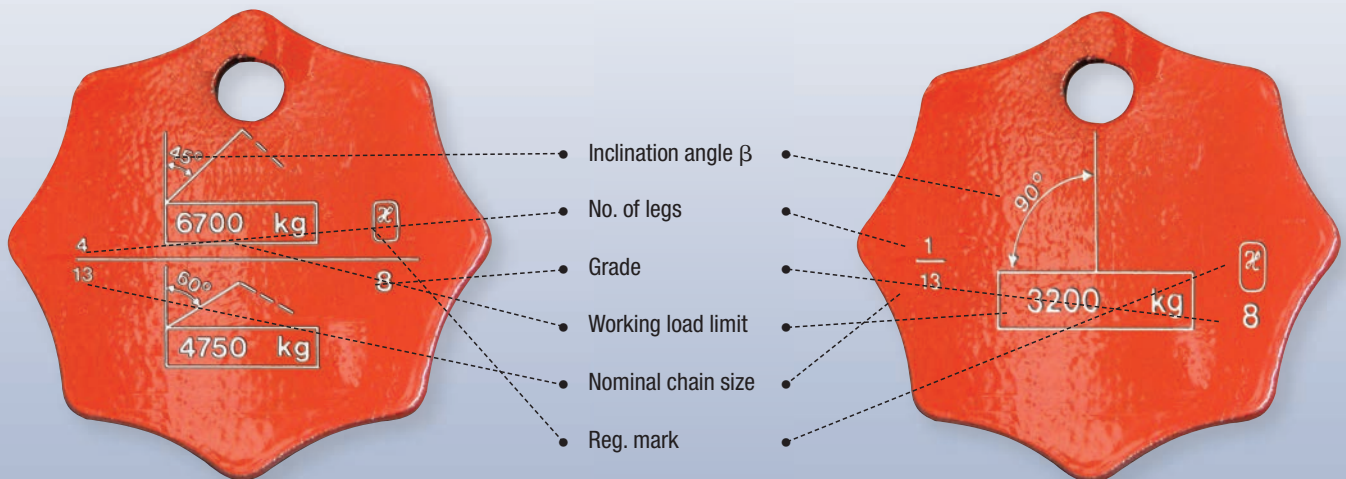



Legal Marking of Grade 80 Chains by the German DGUV

The number 4 under the \mathcal{H} represents a registration number of the German statutory accident insurance (DGUV) and helps to identify/locate the manufacturer in case of damage. The marking is also recognized from all international certification societies as well as from work authorities etc., among others the A. I. B. in Brussels.

Working Load Limit Tables

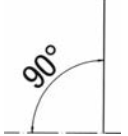
Working Load Limit – Type: Direct Slings

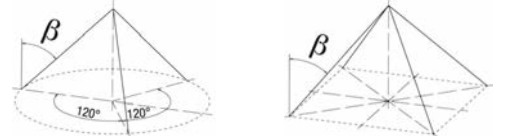
		1-leg	2-leg		3- and 4-leg	
						
Inclination Angle		$\beta = 0^\circ$	$0^\circ < \beta \leq 45^\circ$	$45^\circ < \beta \leq 60^\circ$	$0^\circ < \beta \leq 45^\circ$	$45^\circ < \beta \leq 60^\circ$
Load Factor		1	1,4	1	2,1	1,5
Trade Size	Nominal Size [mm]	[t max.]	[t max.]	[t max.]	[t max.]	[t max.]
6-8	6	1,12	1,60	1,12	2,36	1,70
7-8	7	1,50	2,12	1,50	3,15	2,24
8-8	8	2,00	2,80	2,00	4,25	3,00
10-8	10	3,15	4,25	3,15	6,70	4,75
13-8	13	5,30	7,50	5,30	11,20	8,00
16-8	16	8,00	11,20	8,00	17,00	11,80
18-8	18	10,00	14,00	10,00	21,20	15,00
20-8	20	12,50	17,00	12,50	26,50	19,00
22-8	22	15,00	21,20	15,00	31,50	22,40
26-8	26	21,20	30,00	21,20	45,00	31,50
28-8*	28	25,00	33,50	25,00	50,00	37,50
32-8	32	31,50	45,00	31,50	67,00	47,50
36-8*	36	40,00	56,00	40,00	85,00	60,00
40-8*	40	50,00	71,00	50,00	106,00	75,00
45-8*	45	63,00	90,00	63,00	132,00	95,00
50-8*	50	80,00	112,00	80,00	160,00	118,00
56-8*	56	100,00	140,00	100,00	200,00	150,00
63-8*	63	125,00	170,00	125,00	265,00	190,00
71-8*	71	160,00	224,00	160,00	335,00	236,00



Note: THIELE chain slings are available in mounted and welded execution.

*These chain slings are only available in welded execution.

Table 1

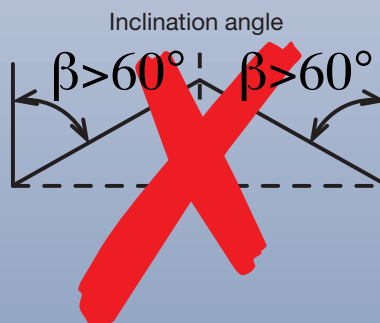

Safety Notice:

Can fail if damaged, misused or overloaded. Inspect before use. Use only if trained. Observe rated capacity in tables 1, 2, 3. DEATH or INJURY can occur from improper use or maintenance.



Working Load Limit Tables

Working Load Limit – Type: Choke Hitch

		1-leg	2-leg		endless chain looped
Inclination Angle		$\beta = 0^\circ$	$0^\circ < \beta \leq 45^\circ$	$45^\circ < \beta \leq 60^\circ$	
Load Factor		0,8	1,12	0,8	1,6
Trade Size	Normal-Size [mm]	[t max.]	[t max.]	[t max.]	[t max.]
6-8	6	0,90	1,25	0,90	1,80
7-8	7	1,25	1,70	1,25	2,50
8-8	8	1,60	2,24	1,60	3,15
10-8	10	2,50	3,55	2,50	5,00
13-8	13	4,25	6,00	4,25	8,50
16-8	16	6,30	9,00	6,30	12,50
18-8	18	8,00	11,20	8,00	16,00
20-8	20	10,00	14,00	10,00	20,00
22-8	22	11,80	17,00	11,80	23,60
26-8	26	17,00	23,60	17,00	33,50
28-8*	28	20,00	28,00	20,00	40,00
32-8	32	25,00	35,50	25,00	50,00
36-8*	36	31,50	45,00	31,50	63,00
40-8*	40	40,00	56,00	40,00	80,00
45-8*	45	50,00	71,00	50,00	100,00
50-8*	50	63,00	90,00	63,00	125,00
56-8*	56	80,00	112,00	80,00	160,00
63-8*	63	100,00	140,00	100,00	200,00
71-8*	71	125,00	180,00	125,00	250,00

Note: THIELE chain slings are available in mounted and welded execution.

*These chain slings are only available in welded execution.

Table 2

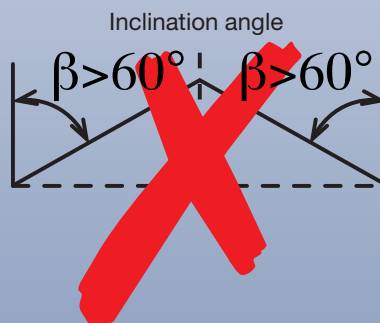

Working Load Limit Tables

Working Load Limit – Type: Endless Chain

		K11		K12	K13	K22	K23
							
Inclination Angle		$\beta = 0^\circ$	$0^\circ < \beta \leq 25^\circ$	$0^\circ < \beta \leq 45^\circ$	$45^\circ < \beta \leq 60^\circ$	$0^\circ < \beta \leq 45^\circ$	$45^\circ < \beta \leq 60^\circ$
Load Factor		1,6	1,45	1,12	0,8	1,7	1,2
Trade Size	Nominal Size [mm]	[t max.]	[t max.]	[t max.]	[t max.]	[t max.]	[t max.]
6-8	6	1,80	1,60	1,25	0,90	1,90	1,32
7-8	7	2,50	2,24	1,70	1,25	2,65	1,80
8-8	8	3,15	2,80	2,24	1,60	3,35	2,36
10-8	10	5,00	4,50	3,55	2,50	5,30	3,75
13-8	13	8,50	7,50	6,00	4,25	9,00	6,30
16-8	16	12,50	11,80	9,00	6,30	13,20	9,50
18-8	18	16,00	15,00	11,20	8,00	17,00	11,80
20-8	20	20,00	18,00	14,00	10,00	21,20	15,00
22-8	22	23,60	22,40	17,00	11,80	25,00	18,00
26-8	26	33,50	30,00	23,60	17,00	35,50	25,00
28-8	28	40,00	35,50	28,00	20,00	42,50	30,00
32-8	32	50,00	47,50	35,50	25,00	53,00	37,50
36-8	36	63,00	60,00	45,00	31,50	67,00	47,50
40-8	40	80,00	71,00	56,00	40,00	85,00	60,00
45-8	45	100,00	90,00	71,00	50,00	106,00	75,00
50-8	50	125,00	112,00	90,00	63,00	132,00	95,00
56-8	56	160,00	140,00	112,00	80,00	170,00	118,00
63-8	63	200,00	180,00	140,00	100,00	212,00	150,00
71-8	71	250,00	224,00	180,00	125,00	265,00	190,00



Table 3



Type K11

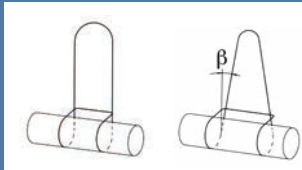
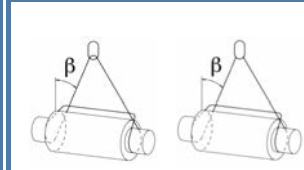
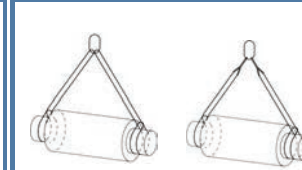

Type K12



Type K22



Load Reductions

Temperature Application Range

Temperature Application Range	Working Load Limit
-40°C to 200°C	100 %
over 200°C to 300°C	90 %
over 300°C to 380°C	75 %

If Grade 80 - alloy slings are used at temperatures exceeding 200°C, then the working load limit has to be reduced. Before using the alloy slings at temperatures below -40°C, the manufacturer has to be consulted.

Table 4

Load Factor at Asymmetry

No. of Legs	1		2		3		4				
	Inclination Angle β	Load Factor	Inclination Angle β	Load Factor	Inclination Angle β	Load Factor	Inclination Angle β	Load Factor			
	-	1	0°–45°	1	45°–60°	1	0°–45°	1,4	45°–60°	1,4	1

Table 5

Round Steel Link Chains TWN 0805



Trade Size	Article-No.			Nominal Size		Pitch		Inside Width	Outside Width	Working Load Limit [t max.]	Weight app. [kgs]
	self-coloured	RAL 9005	corrothiel	d [mm]	tol. \pm [mm]	p [mm]	tol. \pm [mm]	w ₁ [mm min.]	w ₂ [mm max.]		
6-8	F01452	F01453	F01454	6,00	0,24	18,00	0,5	7,80	22,20	1,12	0,8
7-8	F01458	F01459	F01457	7,20	0,20	21,80	0,6	9,45	25,20	1,50	1,1
8-8	F01464	F01465	F01429	8,00	0,32	24,00	0,7	10,40	29,60	2,00	1,4
10-8	F01469	F01470	F01450	10,00	0,40	30,00	0,9	13,00	37,00	3,15	2,2
13-8	F01474	F01475	F01476	13,00	0,52	39,00	1,2	16,90	48,10	5,30	3,8
16-8	F01479	F01480	F01487	16,00	0,64	48,00	1,4	20,80	59,20	8,00	5,7
18-8	F01484	F01485	F04580	18,00	0,90	54,00	1,6	23,40	66,60	10,00	7,3
20-8	F01494	F01495	F04606	20,00	1,00	60,00	1,8	26,00	74,00	12,50	9,0
22-8	F01499	F01500	F04629	22,00	1,10	66,00	2,0	28,60	81,40	15,00	10,9
26-8	F01514	F01515	F04695	26,00	1,30	78,00	2,3	33,80	96,20	21,20	15,2
28-8 *	F01519	F01520	F01521	28,00	1,40	84,00	2,5	36,40	104,00	25,00	17,6
32-8	F01524	F01525	F01526	32,00	1,60	96,00	2,9	41,60	118,00	31,50	23,0
36-8 *	F01529	F01530	F04814	36,00	1,80	108,00	3,0	46,80	133,00	40,00	29,0
40-8 *	F01534	F01535	F04838	40,00	2,00	120,00	4,0	52,00	148,00	50,00	36,0
45-8 *	F01539	F01540	F04889	45,00	2,30	135,00	4,0	58,50	167,00	63,00	45,5
50-8 *	F01545	F01546	F04900	50,00	2,50	150,00	4,5	67,50	180,00	80,00	56,0
56-8 *	F01555	F01556	F04908	56,00	2,80	170,00	5,0	75,60	201,60	100,00	72,5
63-8 *	-	F01566	-	63,00	3,20	190,00	6,0	88,00	230,00	125,00	89,0
71-8 *	-	F01598	-	71,00	3,60	210,00	6,0	99,00	260,00	160,00	110,0

*These sling chains are only available in welded finish.

Elongation at break, self coloured: min. 25%; bright finished: min 20%.

Factor: Working load limit : Proof force : Breaking force = 1 : 2,5 : 4 (200 : 500 : 800 N/mm²)



Suspension Components

THIELE Components of the GK8-Assembly System have a Safety Factor of 4 and comply with all present standards such as EN 818, EN 1677 and DIN 5688-3.

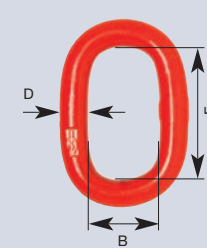
Trade Size	Article-No.	Working Load Limit [t max.]	Dimensions [mm]			Weight app. [kgs]	TWN 0795
			D	F	B		
B 8	F122880	1,12	8	36	18	0,05	 <p>Intermediate Master Link Type B according to DIN 5688-3</p>
B 10	F122890	2,00	10	46	23	0,09	
B 13	F122930	3,15	13	60	30	0,20	
B 16	F122970	5,30	16	70	35	0,36	
B 18	F123010	6,70	18	85	40	0,54	
B 20	F123030	8,00	20	90	45	0,73	
B 22	F123070	10,00	22	100	50	0,97	
B 26	F123090	12,50	26	120	60	1,60	
B 28	F123190	15,00	28	130	65	1,90	
B 32	F123110	21,20	32	140	70	2,90	
B 36	F123130	25,00	36	160	80	4,20	
B 40	F123150	31,50	40	180	90	5,80	
B 45	F123170	40,00	45	200	100	8,20	
B 50	F123210	50,00	50	220	110	11,00	
B 56	F123230	63,00	56	260	130	16,00	
B 63	F123270	80,00	63	280	140	22,00	
B 70	F123290	100,00	70	320	160	31,00	
B 80	F123300	125,00	80	360	180	46,50	
B 90	F123320	160,00	90	400	200	65,50	

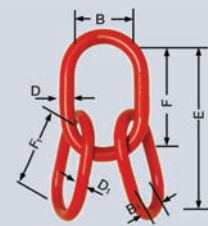

Article-No.	Working L. L. ($\beta = 0^\circ - 45^\circ$) SF= 1:4 [t max.]	Dimensions [mm]							Weight app. [kgs]	TWN 0797 (Offshore)
		E	D	F	B	D ₁	F ₁	B ₁		
F0797268	7,90	340	26	180	100	22	160	90	5,30	 <p>Offshore Master Link Assembly for 3- and 4-Leg Wire Rope</p>
F0797328	11,30	410	32	230	125	26	180	100	9,00	
F0797368	16,00	480	36	250	140	32	230	125	15,00	
F0797458	22,60	570	45	320	175	36	250	140	24,40	
F0797508	26,80	660	50	340	190	45	320	175	40,00	
F0797568	40,00	720	56	380	210	50	340	190	55,00	
F0797638	50,00	810	63	430	240	56	380	210	79,00	

Acc. to DNV 2.7-1:2013-06.

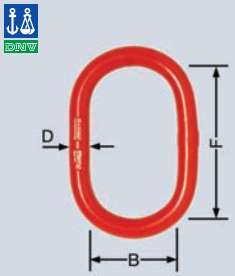

Suspension Components

Article-No.	Working Load Limit [t max.]	Dimensions [mm]			Weight app. [kgs]	TWN 0803 (Offshore)
		D	F	B		
F0803208	4,75	20	140	80	1,10	 <p>Offshore Oblong Master Link Type A</p>
F0803228	5,60	22	160	90	1,50	
F0803268	8,00	26	180	100	2,30	
F0803328	12,50	32	230	125	4,40	
F0803368	16,00	36	250	140	6,20	
F0803408	19,00	40	290	160	8,80	
F0803458	25,00	45	320	175	12,00	
F0803508	31,50	50	340	190	16,00	
F0803568	40,00	56	380	210	23,00	
F0803638	50,00	63	430	240	33,00	
F0803708	63,00	70	470	260	44,00	
F0803808	80,00	80	520	290	64,00	

Acc. to DNV 2.7-1:2013-06.

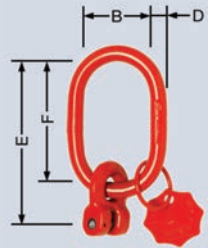

Suspension Components

Trade Size	Article-No.	Working Load Limit [t max.]	Dimensions [mm]				Weight app. [kgs]	TWN 0810/1
			E	D	F	B		
6-8	F08101068	1,12	121	13	90	50	0,40	 <p>Fixed Size Master Link Assembly Type TAA 1 for 1-Leg Sling Chains</p>
8-8	F08101088	2,00	147	16	110	60	1,00	
10-8	F08101108	3,15	176	18	130	70	1,20	
13-8	F08101138	5,30	219	22	160	90	2,30	
16-8	F08101168	8,00	255	26	180	100	4,00	
22-8	F08101228	15,00	350	36	250	140	10,0	

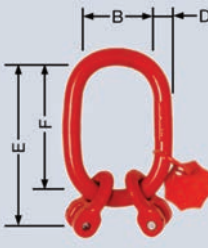

Trade Size	Article-No.	Working Load Limit ($\beta = 0^\circ - 45^\circ$) [t max.]	Dimensions [mm]				Weight app. [kgs]	TWN 0810/2
			E	D	F	B		
6-8	F08102068	1,60	121	13	90	50	0,50	 <p>Fixed Size Master Link Assembly Type TAA 2 for 2-Leg Sling Chains</p>
8-8	F08102088	2,80	167	18	130	70	1,20	
10-8	F08102108	4,25	186	20	140	80	1,90	
13-8	F08102138	7,50	239	26	180	100	4,00	
16-8	F08102168	11,20	305	32	230	125	7,60	
22-8	F08102228	21,20	420	45	320	175	19,60	

Trade Size	Article-No.	Working Load Limit ($\beta = 0^\circ - 45^\circ$) [t max.]	Dimensions [mm]					Weight app. [kgs]	TWN 0810/4
			E	D	F	B	D ₁		
6-8	F08104068	2,36	201	16	110	60	13	1,40	 <p>Fixed Size Master Link Assembly Type TAA 4 for 3- and 4-Leg Sling Chains</p>
8-8	F08104088	4,25	267	22	160	90	16	3,10	
10-8	F08104108	6,70	316	26	180	100	20	5,40	
13-8	F08104138	11,20	409	32	230	125	26	11,10	
16-8	F08104168	17,00	495	40	290	160	28	19,00	
22-8	F08104228	31,50	620	50	340	190	40	42,80	

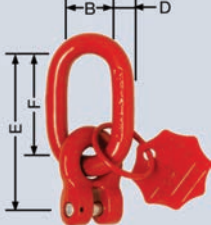

Suspension Components

Trade Size	Article-No.	Working Load Limit [t max.]	Dimensions [mm]				Weight app. [kgs]	TWN 0811/1
			E	D	F	B		
6-8	F08111068	1,12	91	13	60	30	0,31	 <p>Fixed Size Master Link Assembly Type TAB 1 for 1-Leg Sling Chains</p>
8-8	F08111088	2,00	107	16	70	35	0,57	
10-8	F08111108	3,15	136	20	90	45	1,14	
13-8	F08111138	5,30	159	22	100	50	1,84	
16-8	F08111168	8,00	195	26	120	60	3,20	
18-8	F08111188	10,00	219	32	140	70	5,40	
22-8	F08111228	15,00	260	36	160	80	8,00	

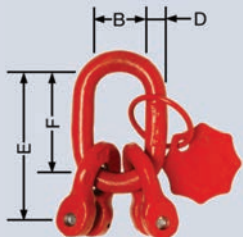
Trade Size	Article-No.	Working Load Limit ($\beta = 0^\circ - 45^\circ$) [t max.]	Dimensions [mm]				Weight app. [kgs]	TWN 0811/2
			E	D	F	B		
6-8	F08112068	1,60	91	13	60	30	0,42	 <p>Fixed Size Master Link Assembly Type TAB 2 for 2-Leg Sling Chains</p>
8-8	F08112088	2,80	107	16	70	35	0,78	
10-8	F08112108	4,25	136	20	90	45	1,60	
13-8	F08112138	7,50	179	26	120	60	3,30	
16-8	F08112168	11,20	205	28	130	65	5,10	
18-8	F08112188	14,00	219	32	140	70	7,90	
22-8	F08112228	21,20	280	40	180	90	13,00	

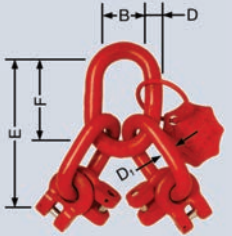
Trade Size	Article-No.	Working Load Limit ($\beta = 0^\circ - 45^\circ$) [t max.]	Dimensions [mm]					Weight app. [kgs]	TWN 0811/4
			E	D	F	B	D ₁		
6-8	F08114068	2,36	161	16	70	35	13	1,20	 <p>Fixed Size Master Link Assembly Type TAB 4 for 3- and 4-Leg Sling Chains</p>
8-8	F08114088	4,25	197	20	90	45	16	2,29	
10-8	F08114108	6,70	236	22	100	50	20	4,07	
13-8	F08114138	11,20	299	26	120	60	26	8,28	
16-8	F08114168	17,00	345	32	140	70	28	13,10	
18-8	F08114188	21,20	379	36	160	80	32	20,00	
22-8	F08114228	31,50	460	40	180	90	40	32,60	

Suspension Components

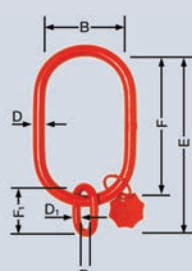
Trade Size	Article-No.	Working Load Limit [t max.]	Dimensions [mm]							Suitable for Crane Hooks acc. DIN 15401 [No.]	Weight app. [kgs]	TWN 0815
			E	D	F	B	D ₁	F ₁	B ₁			
6-8	F08150616	1,12	320	18	260	140	13	60	30	16	1,67	 <p>Technical drawing of the TWN 0815 Master Link Assembly, showing dimensions B, D, L, W, D₁, F₁, and B₁.</p>
8-8	F08150816	2,00	330	22	260	140	16	70	35	16	2,60	
10-8	F08151016	3,15	330	22	260	140	16	70	35	16	2,60	
13-8	F08151316	5,30	260	26	260	140				16	3,17	
16-8	F08151616	8,00	260	30	260	140				16	4,30	
18-8	F08151816	10,00	370	36	250	140	26	120	60	16	7,80	
6-8	F08150625	1,12	400	20	340	180	13	60	30	25	2,54	
8-8	F08150825	2,00	400	20	340	180	13	60	30	25	2,54	
10-8	F08151025	3,15	410	24	340	180	16	70	35	25	3,78	
13-8	F08151325	5,30	410	28	340	180	16	70	35	25	5,07	
16-8	F08151625	8,00	430	32	340	180	20	90	45	25	6,95	
18-8	F08151825	10,00	440	40	340	180	22	100	50	25	10,9	
20-8	F08152025	12,50	340	40	340	180				25	9,97	
22-8	F08152225	15,00	340	40	340	180				25	9,97	
6-8	F08150640	1,12	490	22	430	220	13	60	30	40	3,73	
8-8	F08150840	2,00	490	22	430	220	13	60	30	40	3,73	
10-8	F08151040	3,15	500	26	430	220	16	70	35	40	5,33	
13-8	F08151340	5,30	500	30	430	220	16	70	35	40	7,05	
16-8	F08151640	8,00	520	34	430	220	20	90	45	40	9,41	
18-8	F08151840	10,00	530	42	430	220	22	100	50	40	14,5	
20-8	F08152040	12,50	430	42	430	220				40	13,5	
22-8	F08152240	15,00	430	42	430	220				40	13,5	

Oversize Master Link Assy
 for 1-Leg Sling Chains
 suitable for Crane Hooks
 DIN 15401
 (16 t, 25 t, 40 t)



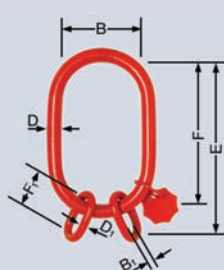

Trade Size	Article-No.	Working Load Limit ($\beta = 0^\circ - 45^\circ$) [t max.]	Dimensions [mm]							Suitable for Crane Hooks acc. DIN 15401 [No.]	Weight app. [kgs]	TWN 0816
			E	D	F	B	D ₁	F ₁	B ₁			
6-8	F08160616	1,60	320	18	260	140	13	60	30	16	1,88	 <p>Technical drawing of the TWN 0816 Master Link Assembly, showing dimensions B, D, L, W, D₁, F₁, and B₁.</p>
8-8	F08160816	2,80	330	22	260	140	16	70	35	16	2,96	
10-8	F08161016	4,25	330	26	260	140	16	70	35	16	3,90	
13-8	F08161316	7,50	350	30	260	140	20	90	45	16	5,75	
16-8	F08161616	11,20	370	36	250	140	26	120	60	16	9,43	
6-8	F08160625	1,60	400	22	340	180	13	60	30	25	3,26	
8-8	F08160825	2,80	410	24	340	180	16	70	35	25	4,14	
10-8	F08161025	4,25	410	28	340	180	16	70	35	25	5,43	
13-8	F08161325	7,50	430	32	340	180	20	90	45	25	7,68	
16-8	F08161625	11,20	440	40	340	180	22	100	50	25	11,9	
18-8	F08161825	14,00	440	40	340	180	22	100	50	25	11,9	
20-8	F08162025	17,00	480	45	340	180	32	140	70	25	18,6	
6-8	F08160640	1,60	500	26	430	220	16	70	35	40	5,70	
8-8	F08160840	2,80	500	26	430	220	16	70	35	40	5,70	
10-8	F08161040	4,25	500	30	430	220	16	70	35	40	7,42	
13-8	F08161340	7,50	500	34	430	220	20	90	45	40	9,88	
16-8	F08161640	11,20	530	42	430	220	22	100	50	40	15,5	
18-8	F08161840	14,00	530	42	430	220	22	100	50	40	15,5	
22-8	F08162240	21,20	570	48	430	220	32	140	70	40	23,7	

Oversize Master Link Assy
 for 2-Leg Sling Chains
 suitable for Crane Hooks
 DIN 15401
 (16 t, 25 t, 40 t)

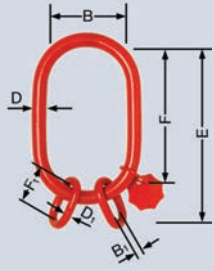

Suspension Components

Trade Size	Article-No.	Working Load Limit ($\beta = 0^\circ - 45^\circ$) [t max.]	Dimensions [mm]							Suitable for Crane Hooks acc. DIN 15401 [No.]	Weight app. [kgs]	TWN 0817
			E	D	F	B	D ₁	F ₁	B ₁			
6-8	F08170616	2,36	330	22	260	140	16	70	35	16	2,96	 <p>Overdose Master Link Assy for 3- and 4-Leg Sling Chains suitable for Crane Hooks DIN 15401 (16 t, 25 t, 40 t)</p>
8-8	F08170816	4,25	330	26	260	140	16	70	35	16	3,90	
10-8	F08171016	6,70	350	30	260	140	20	90	45	16	5,75	
13-8	F08171316	11,20	370	36	250	140	26	120	60	16	9,43	
16-8	F08171616	17,00	370	36	250	140	26	120	60	16	9,43	
6-8	F08170625	2,36	410	24	340	180	16	70	35	25	4,14	
8-8	F08170825	4,25	410	28	340	180	16	70	35	25	5,43	
10-8	F08171025	6,70	430	32	340	180	20	90	45	25	7,68	
13-8	F08171325	11,20	440	40	340	180	22	100	50	25	11,90	
16-8	F08171625	17,00	460	40	340	180	26	120	60	25	13,20	
20-8	F08172025	26,50	590	55	430	220	36	160	80	25	32,30	
6-8	F08170640	2,36	500	26	430	220	16	70	35	40	5,70	
8-8	F08170840	4,25	500	30	430	220	16	70	35	40	7,42	
10-8	F08171040	6,70	520	34	430	220	20	90	45	40	10,10	
13-8	F08171340	11,20	530	42	430	220	22	100	50	40	15,50	
16-8	F08171640	17,00	550	42	430	220	26	120	60	40	16,80	
18-8	F08171840	21,20	570	48	430	220	32	140	70	40	23,70	
22-8	F08172240	31,50	590	55	430	220	36	160	80	40	32,30	

Trade Size	Article-No.	Working Load Limit [t max.]	Dimensions [mm]			Weight app. [kgs]	TWN 0820
			E	F	B		
8-8	F31000	2,00	93,5	68,0	38,0	0,36	 <p>Master Link with Pin Coupling</p>
10-8	F31010	3,20	126,0	95,0	49,0	0,86	
13-8	F31020	5,00	158,5	120,0	60,0	1,60	
16-8	F31030	8,00	187,0	140,0	80,0	3,00	
19-8	Z05828	11,20	261,0	203,0	98,0	5,58	

Suspension Components

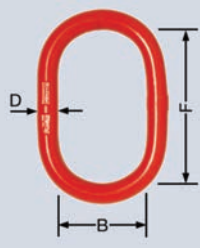
For Chain Slings Trade Size		Article-No.	Working Load Limit [t max.]	Dimensions [mm]			Weight app. [kgs]	TWN 1313
1-Leg	2-Leg			D	F	B		
6 (7)	6	F1313013	2,00	13	90	50	0,29	 <p>Oblong Master Link Type A</p>
8	(7)	F1313016	3,20	16	110	60	0,53	
10	8	F1313018	4,00	18	130	70	0,79	
	10	F1313020	4,80	20	140	80	1,10	
		F1313022	5,60	22	160	90	1,50	
16	13	F1313026	8,00	26	180	100	2,30	
18/20	16	F1313032	12,50	32	230	125	4,40	
22	18	F1313036	16,00	36	250	140	6,20	
	20	F1313040	19,00	40	290	160	8,80	
26/28	22	F1313045	25,00	45	320	175	12,00	
32	26	F1313050	31,50	50	340	190	16,00	
36	28	F1313056	40,00	56	380	210	23,00	
40	32	F1313063	50,00	63	430	240	33,00	
45	36	F1313070	63,00	70	470	260	44,00	
50	40	F1313080	80,00	80	520	290	64,00	
56	45	F1313085	100,00	85	520	290	73,00	
63	50	F1313095	125,00	95	580	320	100,00	
71	56	F1313110	160,00	110	680	380	160,00	

Note: The new TWN 1313 replaces the TWN 0807 and TWN 0808.
Rated for 2-leg chain slings use with inclination angle $0^\circ < \beta \leq 45^\circ$.

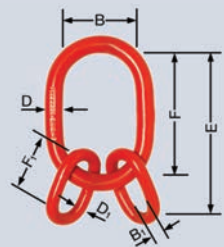
Trade Size	Article-No.	Working Load Limit ($\beta = 0^\circ - 45^\circ$) [t max.]	Dimensions [mm]							Weight app. [kgs]	TWN 1314
			E	D	F	B	D ₁	F ₁	B ₁		
6-8	F1314016	3,15	170	16	110	60	13	60	30	1,40	 <p>Master Link Assembly for 3- and 4-Leg Sling Chains</p>
8-8	F1314020	4,75	210	20	140	80	16	70	35	1,80	
10-8	F1314026	8,00	270	26	180	100	20	90	45	3,80	
13-8	F1314032	12,50	350	32	230	125	26	120	60	7,70	
16-8	F1314040	19,00	420	40	290	160	28	130	65	13,00	
18-8	F1314045	25,00	460	45	320	175	32	140	70	18,00	
20-8	F1314050	31,50	500	50	340	190	36	160	80	25,00	
22-8	F1314050A	31,50	520	50	340	190	40	180	90	28,00	
26-8	F1314063	50,00	630	63	430	240	45	200	100	49,00	
28-8	F1314063A	50,00	630	63	430	240	45	200	100	49,00	
32-8	F1314080	71,00	740	80	520	290	50	220	110	86,00	
36-8	F1314085	85,00	780	85	520	290	56	260	130	106,00	
40-8	F1314095	112,00	860	95	580	320	63	280	140	146,00	
45-8	F1314110	132,00	1000	110	680	380	70	320	160	223,00	
50-8	F1314110A	160,00	1040	110	680	380	80	360	180	252,00	

Note: The new TWN 1314 replaces the TWN 0809.



Suspension Components

New

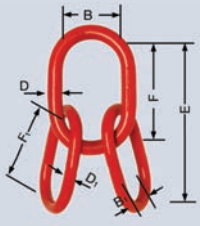
Article-No.	Working Load Limit ($\beta = 0^\circ - 45^\circ$) [t max.] SF= 1:4	Dimensions [mm]							Categorization of the wire rope diameter		Weight app. [kgs]	TWN 1315	
		E	D	F	B	D ₁	F ₁	B ₁	Fiber Rope [mm]	Steel Rope [mm]			
F1315016	2,80	200	16	110	60	13	90	50	11	10	1,10	 <p>Master Link Assembly for 3- and 4-leg Wire Rope Slings acc. to EN 13414-1</p>	
F1315018	4,00	240	18	130	70	16	110	60	13	12	1,90		
F1315022	5,30	290	22	160	90	18	130	70	14	14	3,10		
F1315026	7,50	340	26	180	100	22	160	90	18	16	5,30		
F1315032	11,10	410	32	230	125	26	180	100	22	20	9,00		
F1315036	16,00	480	36	250	140	32	230	125	26	24	15,00		
F1315045	21,00	570	45	320	175	36	250	140	28	28	24,00		
F1315050	31,60	660	50	340	190	45	320	175	36	36	40,00		
F1315056	40,20	720	56	380	210	50	340	190	40	40	55,00		
F1315063	50,10	810	63	430	240	56	380	210	44	44	79,00		
F1315085	101,80	1040	85	520	290	80	520	290	60	60	200,00		

Note: The new TWN 1315 replaces the TWN 0796.

THI-LOK® Connector

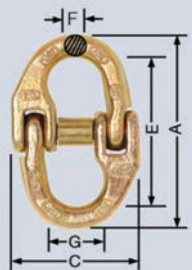
Trade Size	Article-No.	Working Load Limit [t max.]	Dimensions [mm]						Weight app. [kgs]	TWN 1320
			E	G	A	C	B	F		
6-8	F30806	1,12	46	15	62	42	11	6	0,07	 <p>THI-LOK®</p>
7/8-8	F30816	2,00	56	20	78	55	14	9	0,16	
10-8	F30826	3,15	69	25	93	68	18	12	0,30	
13-8	F30836	5,30	84	30	116	75	23	15	0,60	
16-8	F30846	8,00	102	35	146	97	26	19	1,20	
18-8	F30850	10,00	122	36	165	110	31	22	1,86	
20-8	F30855	12,50	134	45	185	122	36	26	2,33	
22-8	F30860	15,00	145	46	198	132	38	26	3,16	
26-8	F30870	21,20	164	55	225	156	44	30	5,00	
32-8	F30880	31,50	192	65	268	192	55	37	9,33	

Hooks

Trade Size	Article-No.	Working Load Limit [t max.]	Dimensions [mm]					Weight app. [kgs]	TWN 0798
			E	D	G	H	C ₁		
6-8	Z07274	1,12	106	22,5	28	22	15	0,48	 <p>Eye Self-Locking Hook</p>
7/8-8	Z07275	2,00	133	24	35	25	20	0,82	
10-8	Z07276	3,15	167	32	45	35	27	1,65	
13-8	Z07277	5,30	208	39	54	41	33	3,12	
16-8	Z07278	8,00	250	49	67	54	39	5,88	
18/20-8	F092255	12,50	257	60	74	57	43	7,33	
22-8	F092275	15,00	290	71	88	62	52	9,91	

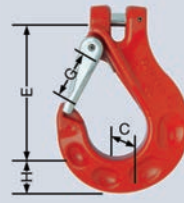

Trade Size	Article-No.	Working Load Limit [t max.]	Dimensions [mm]				Weight app. [kgs]	TWN 0799
			E	G	H	C		
6-8	Z07279	1,12	98	28	22	15	0,57	 <p>Clevis Self-Locking Hook</p>
8-8	Z07280	2,00	122	33	25	20	0,93	
10-8	Z07281	3,15	150	45	35	27	1,75	
13-8	Z07282	5,30	186	54	41	33	3,25	
16-8	Z07296	8,00	215	67	54	39	6,20	
18/20-8	F0922055	12,50	215	74	57	43	7,28	

Trade Size	Article-No.	Working Load Limit [t max.]	Dimensions [mm]				Weight app. [kgs]	TWN 1340/1
			E	G	H	C		
6-8	F336010	1,12	75	24	20	17	0,36	 <p>Clevis Sling Hook with Safety Latch</p>
8-8	F336110	2,00	92	30	25	22	0,75	
10-8	F336210	3,15	113	37	32	28	1,40	
13-8	F336310	5,30	133	42	41	35	2,50	
16-8	F336410	8,00	162	51	50	41	4,40	
18-8*	F33651	10,00	195	60	52	50	7,59	
20-8*	F33656	12,50	220	65	58	55	9,68	
22-8*	F33661	15,00	244	75	64	61	10,62	

New

Note: The new TWN 1340/1 replace the TWN 0835/1 (only trade sizes 6-8 to 16-8).
With heavy duty forged safety latch.

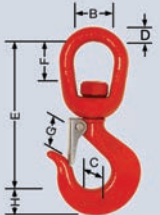

Hooks

Trade Size	Article-No.	Working Load Limit [t max.]	Dimensions [mm]							Weight app. [kgs]	TWN 0854
			E	G	H	C	F	B	D		
0,75-8M	F32103*	0,75	113,5	19	14	13	25	30	10	0,36	 <p>Swivel Hook with Safety Latch</p>
6-8	F32100	1,12	113	21	19	14	25	30	10	0,38	
8-8	F32110	2,00	155	25	24,5	19	42	44	16	1,00	
10-8	F32120	3,15	162	28	28,5	21	42	44	16	1,20	
13-8	F32130	5,30	190	34	33	28	43	51	19	2,08	
16-8	F32140	8,00	247	42	43	35	60	64	25	4,45	

*Upon request.

Note: Also available for wire ropes and thimbles; Swivel hooks are only for stripping and not built for twisting purposes under load.

Note: The hooks TWN 1340/1, TWN 0835/1 and TWN 0858/1 comply to the EN 1677-2. Both forces f_1 and f_2 must withstand min. 300 kg or 10% of working load limit of the hook, depending on which value is larger. But the forces f_2 should not be larger than 20 kN.

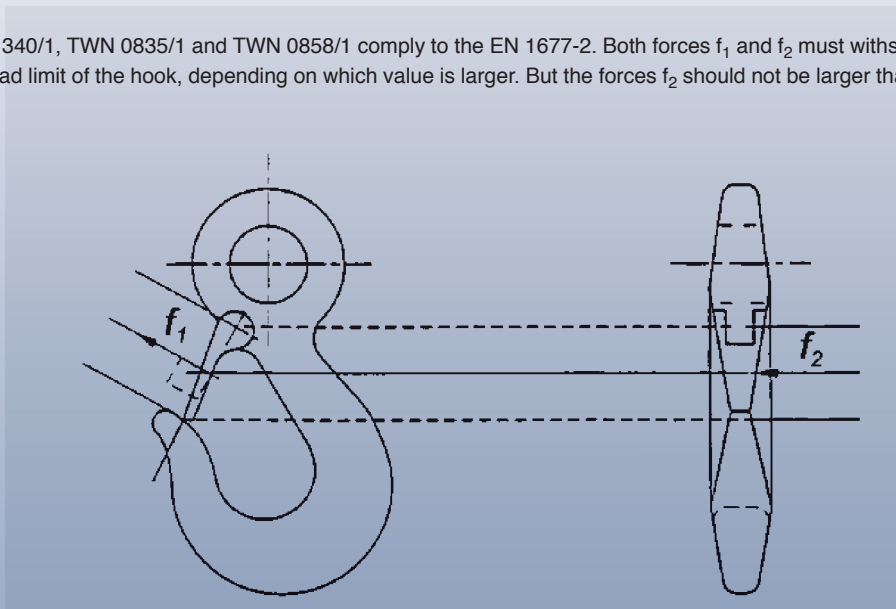

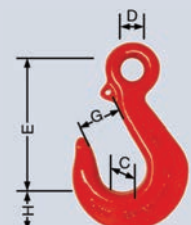

Hooks

Trade Size	Article-No.	Working Load Limit [t max.]	Dimensions [mm]					Weight app. [kgs]	TWN 0855
			E	D	G	H	C		
36-8	Z04079	40,00	388	72	109	103	78	31,50	 <p>Eye Sling Hook</p>
40-8	Z04083	50,00	442	84	124	116	89	46,00	
45-8	Z04080	63,00	494	90	138	130	99	63,00	
50-8	Z04081	80,00	610	102	155	145	110	80,00	

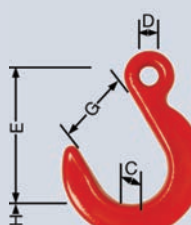

Trade Size	Article-No.	Working Load Limit [t max.]	Dimensions [mm]					Weight app. [kgs]	TWN 0855/1
			E	D	G	H	C		
36-8	Z06159	40,00	388	72	109	103	78	32,30	 <p>Eye Sling Hook with Safety Latch</p>
40-8	Z06160	50,00	442	84	124	116	89	47,00	
45-8	Z06161	63,00	494	90	138	130	99	64,40	
50-8	Z06162	80,00	610	102	155	145	110	81,90	

Trade Size	Article-No.	Working Load Limit [t max.]	Dimensions [mm]					Weight app. [kgs]	TWN 0856
			E	D	G	H	C		
6-8	Z00456	1,12	95	13	50	24	20	0,53	 <p>Eye Foundry Hook</p>
8-8	F32360	2,00	125	18	66	33	27	0,93	
10-8	F32370	3,15	146	20	76	35	32	1,66	
13-8	F32380	5,30	175	26	89	41	38	3,15	
16-8	F32390	8,00	205	32	102	48	45	5,41	
18/20-8	F32400	12,50	235	40	114	54	51	7,50	
22-8	Z00457	15,00	265	47	127	70	65	11,40	
26-8	Z00458	21,20	305	52	136	80	72	13,60	
32-8	Z00459	31,50	327	60	162	93	83	28,00	



Hooks

Trade Size	Article-No.	Working Load Limit [t max.]	Dimensions [mm]						Weight app. [kgs]	TWN 0858/1
			E	D ₁	D ₂	G	H	C		
6-8	F329010	1,12	91	21	11	24	20	17	0,36	
8-8	F329110	2,00	118	28	14	30	25	22	0,78	
10-8	F329210	3,15	145	36	18	37	32	28	1,50	
13-8	F329310	5,30	168	42	21	42	41	35	2,55	
16-8	F329410	8,00	210	54	25	51	50	41	4,65	
18/20-8	F329510	12,50	270	62	30	65	58	55	8,70	
22-8	F329710	15,00	271	65	30	70	62	54	9,77	
26-8	F329810	21,20	302	70	33	75	71	59	14,20	
32-8	F329910	31,50	350	80	38	90	86	67	23,80	



SOLIDO®
Eye Sling Hook
with Safety Latch

Note: Forged safety latch.

Trade Size	Article-No.	Working Load Limit [t max.]	Dimensions [mm]				Weight app. [kgs]	TWN 0859
			E	G	H	C		
8-8	F33310	2,00	110	66	33	27	1,00	
10-8	F33320	3,15	133	76	35	32	1,61	
13-8	F33330	5,30	159	89	41	38	3,40	
16-8	F33340	8,00	189	102	48	45	5,50	

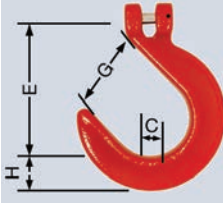

Clevis Foundry Hook

Trade Size	Article-No.	Working Load Limit [t max.]	Dimensions [mm]					Weight app. [kgs]	TWN 0860
			E	G	R	D	B		
	F18130	0,15	80	28	14	10	16	0,12	
	F18160	0,25	100	36	18	12	20	0,21	
	F18180	0,40	130	46	23	16	25	0,48	
	F18200	0,80	160	56	28	20	30	0,91	
6-8	F18220	1,12	180	64	32	22	32	1,20	
7-8	F18230	1,50	200	70	35	26	35	1,90	
8-8	F18250	2,00	230	80	40	32	40	3,40	
10-8	F18260	3,15	260	90	45	36	45	4,80	
	F18280	4,00	300	104	52	40	52	6,80	
	F18290	4,50	350	122	61	45	60	10,00	
13-8	F18300	5,30	400	140	70	51	68	14,60	
	F18310	6,00	450	158	79	57	75	20,50	
16-8	F18320	8,00	500	160	80	63	80	27,40	
18-8	F18330	10,00	550	166	83	72	85	39,00	

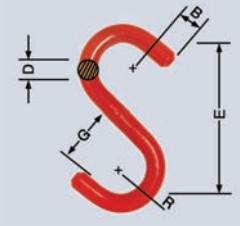

S-Hook



Hooks

Trade Size	Article-No.	Working Load Limit [t max.]	Dimensions [mm]							Weight app. [kgs]	TWN 0887
			E	G	H	C	D	F	B		
	F32160	0,35	98,5	14	14	14	9	20	16	0,24	 <p>Swivel Hook</p>

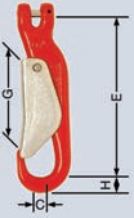
Trade Size	Article-No.	Working Load Limit [t max.]	Dimensions [mm]				Weight app. [kgs]	TWN 0889
			E	G	H	C		
6-8*	F33439	0,50	137	19	13	12	0,55	 <p>Lifting Hook for Engines</p>

*Note: For trade size 6-8, but WLL limited to max 0,5 t.

Shortening Components

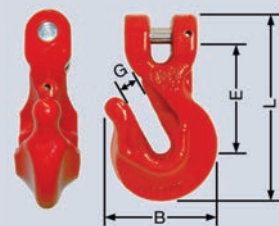
Trade Size	Article-No.	Working Load Limit [t max.]	Dimensions [mm]				Weight app. [kgs]	TWN 0827
			E	G	L	B		
8-8	F33200	2,00	61	9	101	61	0,53	 Clevis Shortening Hook
10-8	F33210	3,15	73	12	125	75	0,97	
13-8	F33220	5,30	95	15	160	95	2,18	
16-8	F33230	8,00	112	18	188	120	3,40	
20-8	F33245	12,50	148	22,5	242	141	7,30	

Note: With extra wide chain bed.

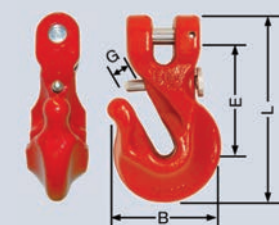
Trade Size	Article-No.	Working Load Limit [t max.]	Dimensions [mm]				Weight app. [kgs]	TWN 0827/1
			E	G	L	B		
8-8	F33201	2,00	61	9	101	61	0,54	 Clevis Shortening Hook with Safety Pin
10-8	F33211	3,15	73	12	125	75	0,99	
13-8	F33221	5,30	95	15	160	95	2,18	
16-8	F33231	8,00	112	18	188	120	3,45	
20-8	F33246	12,50	148	22,5	242	141	7,35	

Note: With extra wide chain bed, complies to DIN 5692.

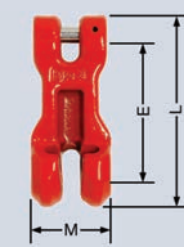
Trade Size	Article-No.	Working Load Limit [t max.]	Dimensions [mm]			Weight app. [kgs]	TWN 0851
			E	L	M		
6-8	F34910	1,12	54	81	32	0,21	 Clevis Shortening Claw
7-8	F34920	1,50	74	108	43	0,42	
8-8	F34925	2,00	80	115	46	0,56	
10-8	F34930	3,15	90	134	56	0,94	
13-8	F34940	5,30	117	175	72	2,10	
16-8	F34950	8,00	144	214	86	3,57	
18-8	F34960	10,00	162	241	98	5,40	
20-8	F34970	12,50	158	241	98	5,40	
22-8	F34980	15,00	198	295	118	9,00	
26-8	F34985	21,20	195	309	130	12,00	
32-8	F34990	31,50	240	381	160	19,00	



Shortening Components

Trade Size	Article-No.	Working Load Limit [t max.]	Dimensions [mm]						Weight app. [kgs]	TWN 0896
			E	E ₁	E ₂	B-Link				
6-8	F0896068	1,12	137	31	60	10	46	23	0,32	 <p>Shortening Device for fixed size Master Link</p>
8-8	F0896088	2,00	176	38	78	13	60	30	0,68	
10-8	F0896108	3,15	215	46	99	16	70	35	1,41	
13-8	F0896138	5,30	270	59	126	18	85	40	2,60	
16-8	F0896168	8,00	326	76	150	22	100	50	4,60	
18-8	F0896188	10,00	347	79	168	22	100	50	6,30	
22-8	F0896228	15,00	450	100	210	32	140	70	12,00	

Shackles

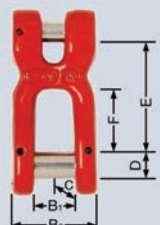
Trade Size	Article-No.	Working Load Limit [t max.]	Dimensions [mm]						Weight app. [kgs]	TWN 0861
			E	D	C	F	B ₁	B ₂		
10-8	F30601	3,15	64	16	32	36	21	47	0,61	 <p>Chain Coupling Shackle with Safety Bolt</p>
13-8	F30611	5,30	83	20	40	49	27	61	1,24	
16-8	F30621	8,00	99	24	48	56	33	75	2,10	
18-8	F30631	10,00	115	30	60	63	42	100	3,93	

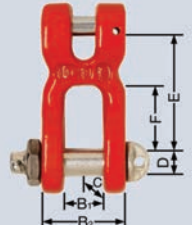
Trade Size	Article-No.	Working Load Limit [t max.]	Dimensions [mm]						Weight app. [kgs]	TWN 0862
			E	D	C	F	B ₁	B ₂		
10-8	F30600	3,15	64	16	32	36	21	47	0,67	 <p>Chain Coupling Shackle with Safety Bolt, Nut and Cotter Pin</p>
13-8	F30610	5,30	83	20	40	49	27	61	1,37	
16-8	F30620	8,00	99	24	48	56	33	75	2,28	
18-8	F30630	10,00	115	30	60	63	42	100	4,37	

Shackles

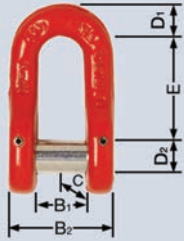
Trade Size	Article-No.	Nominal Size [DIN 82101]	Working Load Limit [t max.]	Dimensions [mm]						Weight app. [kgs]	TWN 0870
				E	D ₁	D ₂	C	B ₁	B ₂		
10-8	F30311	1	3,15	49	15	16	32	21	47	0,35	 <p>Bolt Shackle Type C</p>
13-8	F30321	1,6	5,30	61	19	20	40	27	61	0,74	
16-8	F30331	2,5	8,00	73	23	24	48	33	75	1,30	
18/20-8	F30341	4	12,50	91	29	30	60	42	96	2,60	
22-8	F30351	5	15,00	111	33	36	72	47	107	4,00	
26-8	F30361	6	21,20	120	37	39	78	53	121	5,70	
28-8	F30371	8	25,00	140	41	45	90	60	136	10,00	
32-8	F30381	10	31,50	147	45	48	96	66	150	10,50	
36-8	F30391	12	40,00	158	50	52	104	73	167	13,90	
40-8	F30401	16	50,00	185	55	60	120	81	185	20,50	
45-8	F30411	20	63,00	211	61	68	136	90	206	26,60	

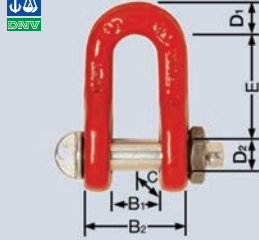
Trade Size	Article-No.	Nominal Size [DIN 82101]	Working Load Limit [t max.]	Dimensions [mm]						Weight app. [kgs]	TWN 0871
				E	D ₁	D ₂	C	B ₁	B ₂		
6-8*	Z04147	0,4	1,12	30	8	10	20	14	30	0,10	 <p>Safety Bolt Shackle Type C with Nut and Cotter Pin</p>
8-8	Z04145	0,6	2,00	36	10	12	24	17	37	0,20	
10-8	F30310	1	3,15	49	15	16	32	21	47	0,45	
13-8	F30320	1,6	5,30	61	19	20	40	27	61	0,84	
16-8	F30330	2,5	8,00	73	23	24	48	33	75	1,40	
18/20-8	F30340	4	12,50	91	29	30	60	42	96	3,10	
22-8	F30350	5	15,00	111	33	36	72	47	107	4,50	
26-8	F30360	6	21,20	120	37	39	78	53	121	6,30	
28-8	F30370	8	25,00	140	41	45	90	60	136	10,10	
32-8	F30380	10	31,50	147	45	48	96	66	150	12,30	
36-8	F30390	12	40,00	158	50	52	104	73	167	15,60	
40-8	F30400	16	50,00	185	55	60	120	81	185	22,20	
45-8	F30410	20	63,00	211	61	68	136	90	206	26,30	

*Finish: Electro galvanized, welded on nut.

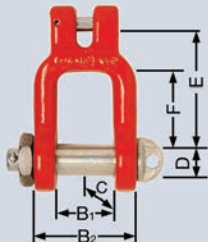
Trade Size	Article-No.	Working Load Limit [t max.]	Dimensions [mm]						Weight app. [kgs]	TWN 0897
			E	D ₁	C ₂	F	B ₁	B ₂		
6-8	F30586	1,12	70	20	39	46	35	65	0,47	 <p>Special Coupling Bolt Shackle with Safety Bolt, Nut and Cotter Pin</p>
8-8	F30596	2,00	70	20	40	46	35	65	0,54	

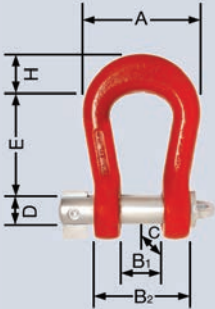

Shackles

Trade Size DIN 82016	Article-No.	Working Load Limit [t max.]	Dimensions [mm]								Weight app. [kgs]	TWN 0898
			E	D	H	C	B ₁	B ₂	A			
10	F38355	35	166	48	60	96	66	150	186	11,86		
20	F38370	70	231	68	85	136	90	206	256	31,46		

Cargo Shackle

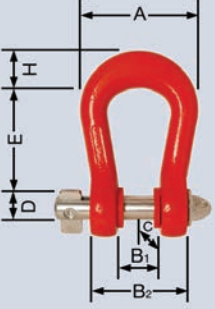
Trade Size DIN 82016	Article-No.	Working Load Limit [t max.]	Dimensions [mm]								Weight app. [kgs]	TWN 0898/1
			E	D	H	C	B ₁	B ₂	A			
10	F38357	35	171	38	60	96	48	150	186	11,62		

Cargo Shackle with Bush

Chain Tensioners

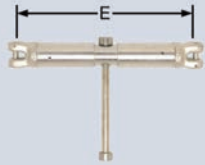
Trade Size	Article-No.	Norm. straight load (S_{TF}) [daN min.]	Lashing Capacity (LC) [kN max.]	Dimensions [mm]			Weight app. [kgs]	TWN 1450
				$E_{max.}$	$E_{min.}$	hub		
8-8	F34179	1800	40	345	270	75	2,10	
10-8	F34199	2200	63	375	275	100	2,70	
13-8	F34189	2600	100	460	340	120	4,00	

Short Chain Tensioner acc. to DIN EN 12195-3

Note: Can also be used in slings; also rated for lifting.

Trade Size	Article-No.	Norm. straight load (S_{TF}) [daN min.]	Lashing Capacity (LC) [kN max.]	Dimensions [mm]			Weight app. [kgs]	TWN 1451
				$E_{max.}$	$E_{min.}$	hub		
8-8	F34175	1800	40	345	270	75	2,50	
10-8	F34195	2200	63	375	275	100	3,50	
13-8	F34185	2600	100	460	340	120	5,00	

Short Chain Tensioner with Ratchet acc. to DIN EN 12195-3

Note: Can also be used in slings; also rated for lifting.

Trade Size	Article-No.	Norm. straight load (S_{TF}) [daN min.]	Lashing Capacity (LC) [kN max.]	Dimensions [mm]			Weight app. [kgs]	TWN 1452
				$E_{max.}$	$E_{min.}$	hub		
13-8	F341871	2600	100	675	445	230	7,20	
16-8	F34197	3100	160	835	555	280	11,80	

Chain Tensioner (long lift) acc. to DIN EN 12195-3

Note: Can also be used in slings; also rated for lifting.

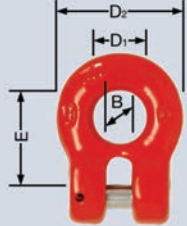

Special Sling Components

Trade Size	Article-No.	Working Load Limit [t max.]	Dimensions [mm]				Weight app. [kgs]	TWN 0812
			E	D ₁	D ₂	B		
6-8	F31700	1,12	31	17	39	8	0,10	 <p>Ringshackle</p>
8-8	F31710	2,00	37	21	50	11	0,20	
10-8	F31720	3,15	46	26	62	14	0,40	
13-8	F31730	5,30	59	33	79	18	0,87	
16-8	F31740	8,00	75	42	99	22	1,60	
18-8	F31750	10,00	79	47	111	25	2,50	
22-8	F31760	15,00	100	55	136	31	3,80	

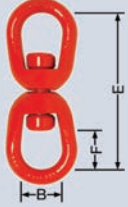
Trade Size	Article-No.	Working Load Limit [t max.]	Dimensions [mm]			Weight app. [kgs]	TWN 0845
			E	F	B		
6-8	F34000	1,12	108	27	30	0,33	 <p>Swivel</p>
8-8	F34010	2,00	168	44	44	1,33	
10-8	F34020	3,15	168	44	44	1,33	
13-8	F34030	5,30	184	46	51	2,10	
16-8	F34040	8,00	252	66	64	4,45	

Special Sling Components

New

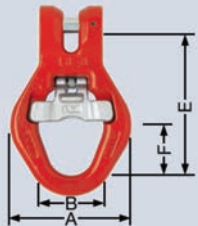
Trade Size	Article-No.	Working Load Limit [t max.]	Dimensions [mm]				Weight app. [kgs]	TWN 0869
			E	F	B	A		
13-8	F313800	5,30	142	57,5	65	122	1,92	 <p>Skip Suspension Link with Pin Coupling and forged Safety Latch</p>
16-8	F313850	8,00	141	57,5	65	122	1,92	

New

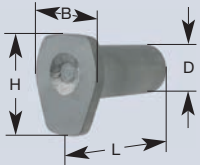
Trade Size	Article-No.	Dimensions [mm]				Weight app. [kgs]	TWN 0869/1
		L	D	B	H		
1	F31410	110	45	68	82	1,60	 <p>Container Centring Pivo</p>

Trade Size	Working Load Limit [t max.]		Dimensions [mm]				Weight app. [kgs]	TWN 0875
	from	to	L	D	F	B		
1	3,15	5,30		13	60	30	4,02	 <p>Reduction Assembly</p>
2	6,30	10,00		18	85	40	17,46	
3	12,50	20,00		26	120	60	–	

Note: Please indicate the dimension of the crane hook or crane hook no.





Special Sling Components

Trade Size	Article-No.	Dimensions [mm]								Weight app. [kgs]	TWN 0882
		E	A	D ₁	D ₂	B	C	F			
6-8	F48300	42	100	14	18	8	11	10	0,40		
8-8	F48303	56	130	18	22	10	15	12	0,80		
10-8	F48306	70	160	22	28	13	19	15	1,50		
13-8	F48309	91	210	28	40	16	25	20	3,40		
16-8	F48312	110	260	36	42	20	30	25	5,60		
18-8	F48313	130	290	40	54	23	34	25	8,40		
20-8	F48322	130	300	42	54	25	35	30	10,90		
22-8	F48315	140	330	46	56	28	39	35	15,20		
26-8	F48319	170	390	54	66	33	46	40	24,70		
32-8	F48321	210	480	68	80	40	54	50	47,40		
32-8	F48325	200	700	68	80	40	56	50	64,92		
Trade Size	Working Load Limit [t max.]		Breaking Force [kN min.]								
	$0^\circ < \beta \leq 45^\circ$	$45^\circ < \beta \leq 60^\circ$									
6-8	1,60	1,12	71								
8-8	2,80	2,00	124								
10-8	4,25	3,15	200								
13-8	7,50	5,30	340								
16-8	11,20	8,00	490								
18-8	14,00	10,00	628								
20-8	17,00	12,50	785								
22-8	21,20	15,00	950								
26-8	30,00	21,20	1.300								
32-8	45,00	31,50	1.960								

Balancer

Special Sling Components

Trade Size	Article-No.	Working Load Limit [t max.]	Dimensions [mm]						Weight app. [kgs]	TWN 0892
			E	d	D ₁	D ₂	D ₃	F		
10-8	F34250	3,15	168	17	20	17	40	25	0,82	 <p>Key Hook</p>

Trade Size	Article-No.	Working Load Limit [t max.]	Dimensions [mm]						Weight app. [kgs]	TWN 0893	
			E	D	F	B	G	H			C
6-8	F08904	1,12	307	18	130	70	24	20	17	1,73	 <p>Isolation Assembly</p>
8-8	F08912	2,00	329	18	130	70	30	25	22	2,16	
10-8	F08898	3,15	371	18	130	70	37	32	28	3,25	
13-8	F08899	5,30	425	22	160	90	42	41	35	5,27	

Note: Isolates a power flow rate till max. 1.000 Volt.

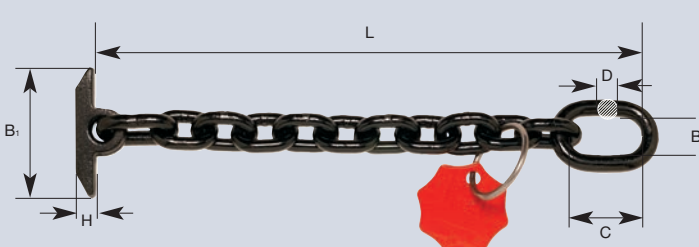
Trade Size	Article-No.	Working Load Limit [t max.]	Dimensions [mm]						Weight app. [kgs]	TWN 0894
			L	D	C	B	B ₁	H		
10-8	F08811	1,60	405,5	13	60	30	95	14,5	1,70	 <p>T-Handle Chain</p>
10-8	F08812	1,60	675,5	13	60	30	95	14,5	2,30	



Special Sling Components

Trade Size	Article-No.	Working Load Limit [t max.]	Dimensions [mm]					Weight app. [kgs]	TWN 0895
			E	D	F	G	A		
13-8	F30975	5,30	79	36	28	28	82	1,20	 <p>Swivel Adapter</p>

Note: Working load limit for vertical load only.



Lashing Chains

Trade Size	Article-No.	Lashing Capacity (LC) under straight load [kN max.]	Weight app. [kgs]	TWN 1400
8-8	F34171	40	8,50	 <p>Lashing Chain with Spindle Tensioner</p>
10-8	F34172	63	12,50	
13-8	F34173	100	21,00	
16-8	F34174	160	37,70	



Trade Size	Article-No.	Lashing Capacity (LC) under straight load [kN max.]	Weight app. [kgs]	TWN 1401
8-8	F34171R	40	8,50	 <p>Lashing Chain with Ratchet</p>
10-8	F34172R	63	12,50	
13-8	F34173R	100	21,00	



Magnet Chain Slings TWN 0601

Trade Size	Article-No.	Working Load Limit [t max.]	Working Length [mm] E	D-Link [mm]			Master-Link [mm]			Weight app. [kgs]	TWN 0601
				D ₁	F ₁	B ₁	D ₂	F ₂	B ₂		
16-8	F08945	21,30	776	45	260	155	20	90	45	21,5	
20-8	F08946	33,40	940	51	260	155	26	120	60	35,5	
22-8	F08947	40,25	1.002	57	300	165	26	120	60	46,0	
26-8	F08948	56,25	1.126	57	300	165	32	140	70	64,0	
32-8	F08961	85,20	1.362	63	330	165	40	180	90	108,0	

Note: The Magnet Chain Slings acc. to this works standard are made for safe lift of electro magnets.
 The dimensions, working load limits as well as the manufacturing proof- and break-force comply with the ASTM A391/A391M, the marking meets the requirement of the EN 818-1.
 The D-type master links and the B-type connecting- and intermediate links comply with DIN 5688-3.
 The ratio between working load to proof load to break load is 1 : 2 : 4.
 The maximum inclination angle is 30°.

Spare Parts and Accessories

Trade Size	Article-No.	Packaging Unit	Weight app. [kgs]	TWN 0904/0
6-8	F48694	1 set	0,01	 <p>Load Pin for Clevis Type Hooks</p>
8-8	F48352	1 set	0,01	
10-8	F48355	1 set	0,03	
13-8	F48358	1 set	0,07	
16-8	F48361	1 set	0,11	
18-8	F48364	1 set	0,20	
20-8	F48369	1 set	0,26	
22-8	F48367	1 set	0,31	
26-8	F48373	1 set	0,50	
32-8	F48371	1 set	0,91	



Trade Size	Article-No.	Packaging Unit	Weight app. [kgs]	TWN 0905 / 0906
10-8	F48036	1 set	0,07	 <p>Load-Spirol Pins for Chain Coupling Shackles and Chain Shackles</p>  <p>(TWN 0861, TWN 0870)</p>
13-8	F48039	1 set	0,14	
16-8	F48042	1 set	0,25	
18/20-8	F48045	1 set	0,44	
22-8	F48048	1 set	0,78	
26-8	F48051	1 set	1,05	
28-8	F48054	1 set	1,60	
32-8	F48057	1 set	2,02	
36-8	F48060	1 set	2,60	
40-8	F48063	1 set	3,89	

Trade Size	Article-No.		Packaging Unit	Weight app. [kgs]	TWN 0920 - 0922
	TWN 0854	TWN 0855/1			
6-8	F48420		1 set	0,02	 <p>Latch Set for Eye Hooks and Swivel Hooks</p>  <p>(TWN 0854, 0855/1)</p>
8-8	F48423		1 set	0,03	
10-8	F48426		1 set	0,04	
13-8	F48429		1 set	0,11	
16-8	F48469		1 set	0,19	
36-8		Z06163	1 set	0,80	
40-8		Z06164	1 set	1,00	
45-8		Z06165	1 set	1,40	
50-8		Z06166	1 set	1,90	





Spare Parts and Accessories

Trade Size	Article-No.	Packaging Unit	Weight app. [kgs]	TWN 1920
6-8	F486012	1 set	0,01	 <p>Spare Part Set for THI-LOK®</p>  <p>(TWN 1320)</p>
8-8	F486042	1 set	0,02	
10-8	F486072	1 set	0,04	
13-8	F486102	1 set	0,06	
16-8	F486132	1 set	0,11	

Trade Size	Article-No.	Packaging Unit	Weight app. [kgs]	TWN 1920
18-8	F48615	1 set	0,17	 <p>Spare Part Set for THI-LOK®</p>  <p>(TWN 1320)</p>
20-8	F48617	1 set	0,27	
22-8	F48619	1 set	0,28	
26-8	F48622	1 set	0,47	
32-8	F48625	1 set	0,85	

Trade Size	Article-No.	Packaging Unit	Weight app. [kgs]	TWN 0930-0932
10-8	F30451	1 set	0,13	 <p>Spare Part Set for chain couplings Bolt Shackle and C-Shackle</p>  <p>(TWN 0862, TWN 0871)</p>
13-8	F30461	1 set	0,25	
16-8	F30471	1 set	0,36	
18/20-8	F30481	1 set	0,97	
22-8	F30491	1 set	1,31	
26-8	F30501	1 set	1,99	
28-8	F30511	1 set	2,89	
32-8	F30521	1 set	3,69	
36-8	F30531	1 set	4,48	
40-8	F30541	1 set	6,65	
45-8	F30551	1 set	8,20	

Spare Parts and Accessories

Trade Size	Article-No.	Packaging Unit	Weight app. [kgs]	TWN 0950-0952
8-8	F48330	1 set	0,01	 <p>Spare Part Set for Shortening Hook</p>  <p>(TWN 0827/1)</p>
10-8	F48328	1 set	0,02	
13-8	F48329	1 set	0,03	
16-8	F48339	1 set	0,05	
20-8	F48345	1 set	0,10	



Trade Size	Article-No.	Packaging Unit	Weight app. [kgs]	TWN 0962
13/16-8	F31404	1 set	0,28	 <p>Spare Set for Skip Suspension Link</p>  <p>(TWN 0869) Old version</p>

Trade Size	Article-No.	Packaging Unit	Weight app. [kgs]	TWN 0967/0
6-8	F333700	1 set	0,01	 <p>Spare Pin for Clevis Self-Locking Hook</p>  <p>(TWN 0799)</p>
8-8	F333711	1 set	0,02	
10-8	F333721	1 set	0,03	
13-8	F333730	1 set	0,06	
16-8	F333741	1 set	0,17	
18/20-8	F0922057	1 set	0,22	



Spare Parts and Accessories



Trade Size	Article-No.	Packaging Unit	Weight app. [kgs]	TWN 0967/1
6-8	F329090	1 set	0,02	 <p>Trigger Set for Self-Locking Hooks</p>  <p>(TWN 0798, TWN 0799)</p>
8-8	F329190	1 set	0,03	
10-8	F329290	1 set	0,04	
13-8	F329390	1 set	0,06	
16-8	F329490	1 set	0,11	
18/20-8	F0922056	1 set	0,27	
22-8	F0922056	1 set	0,33	

Trade Size	Article-No.	Packaging Unit	Weight app. [kgs]	TWN 0968
13-8	F480131	1 set	0,07	 <p>Spare Pin for Skip Suspension Link</p>  <p>(TWN 0869) New version</p>
16-8	F480161	1 set	0,12	

Trade Size	Article-No.	Packaging Unit	Weight app. [kgs]	TWN 0969
13/16-8	F314081	1 set	0,20	 <p>Spare Set for Skip Suspension Link</p>  <p>(TWN 0869) New version</p>



Spare Parts and Accessories

Trade Size	Article-No.	Packaging Unit	Weight app. [kgs]	TWN 1908/5
6-8	F48730	1 set	0,02	 <p>Spare Parts for Sling Hooks</p>  <p>(TWN 0835/1, TWN 0858/1, TWN 1340/1)</p>
8-8	F48732	1 set	0,03	
10-8	F48734	1 set	0,13	
13-8	F48736	1 set	0,26	
16-8	F48738	1 set	0,31	
18-8*	F48585	1 set	0,56	
18/20-8	F48742	1 set	0,75	
22-8	F48744	1 set	0,98	
22-8*	F48588	1 set	1,02	
26-8	F48746	1 set	1,43	
32-8	F48747	1 set	2,43	

*For TWN 0835/1 (TWN 0908/0).

Article-No. Single Leg	Article-No. Multi Leg	Diameter [mm]	Weight app. [kgs]	TWN 0940
F08040 ¹⁾	F08044 ¹⁾	70	0,10	 <p>Identification Tag for Single and Multi Leg Sling Chain</p>
F08042 ²⁾	F08046 ²⁾	70	0,11	

1) Without welded ring.
2) With welded ring.



Chain and Wire Rope Cutter TWN 0941

Function and Design

The mobile THIELE universal chain and wire rope cutting machine allows an easy cutting, mounting and inspection of chain and wire rope slings.

The THIELE universal chain and wire rope cutting machines can be easily and safely moved due to light steerable wheels and fulfil the latest accident prevention regulations (DGUV). The compact hydraulic unit is controlled by a foot switch, allowing the cutting of chain or wire rope due to fast interchangeable blades. The cutting machine has a lockable tool compartment and a large work top.



Drive:	Electro-hydraulic with 700 kN shearing force
Article-No.:	F48950
Voltage:	220/380 V 3 Ph. 50 Hz, 220 V 1 Ph. 50 Hz or 440 V 3 Ph. – 60 Hz, Export
Dimensions (L x W x H):	app. 1.100 x 920 x 1.500 mm (with closed protection cover)
Working Height:	app. 1.100 mm
Weight:	app. 270 kgs

Cutting Range

Round link chains according to EN 817-7, EN 818-2-8, 818-2-8, ASTM 391, ASTM 973 – grade 80 / 100 and DIN 22 252 up to 26 mm diameter, wire rope up to 30 mm diameter and with a strength of 1600 N/mm², higher strengths and larger diameters on request.

Accessories

- 1 set of tools for changing the blades,
- 2 sets of blades, one each for chains and wire rope

The chain and wire rope cutting machine has one of the above mentioned voltages. The hydraulic tank is filled with hydraulic oil. The oil level is to be checked regularly and refilled if necessary.

Special Accessories

- 1. Holding Clamp:** The holding clamp keeps the wire rope at a right angle to the cutting direction.
- 2. Stroke Adjustment:** With the stroke adjustment, the cutting stroke can be adjusted from 0 mm to 50 mm. The advantage is that a no load operation is avoided when cutting small diameters (working time is saved).
- 3. Wire Rope Clamp:** The wire rope clamp prevents the wire rope from falling onto the ground after it has been cut, which always has to be picked up (easier to work with and assists working time).



Spare Parts and Accessories

Trade Size	Article-No.	Packaging Unit	Weight app. [kgs]	TWN 0944
–	Z04575	–	0,01	 <p>Chain Card File</p>

Note: Form to file the regular inspections of slings according to DIN EN standard.



Trade Size	Article-No.	Packaging Unit	Weight app. [kgs]	TWN 0945
–	Z03303	–	0,60	 <p>Assembly Set</p>

Note: Consisting of 6 punches in a plastic holder to disassemble chains from components. The complete set covers all sizes of the the THIELE Sling System.

Trade Size	Article-No.	Packaging Unit	Weight app. [kgs]	TWN 0946
–	F48856	–	0,20	 <p>Chain Gauge Set</p>

Note: For regular wear inspection of chain sizes 6-8 to 32-8.

Trade Size	Article-No.	Packaging Unit	Weight app. [kgs]	TWN 1402
–	Z07264	–	0,05	 <p>Identification Tag</p>

Note: Identification tag for lashing chains acc. to EN 12195-3.



THIELE Key Design

Mounted chain slings



TA 2 A / 10-8 - R e a c h - T W N 0856

	TA	2	A	/	10	-	8	T	2000	T W N	1340	/	1	R A L	9005	R A L	3003
THIELE chain slings	[]																
No. of legs (1...4)	[]																
Execution (master or intermediate link)	[]																
Trade size - grade	[]																
Type of assembly	[]																
T - THI-LOK® / R - ringshackle	[]																
Use length in mm (rounded up)	[]																
TWN of bottom components	[]																
Surface finish of chain	[]																
Standard: black coloured (RAL 9005)	[]																
Colour of components	[]																
Standard: red coloured (RAL 3003)	[]																

Always indicate the THIELE key design in case of order.

Example (Pic. in the middle): TA 2 A / 10-8 _ _ _ _ T W N 0856 (RAL 9005, RAL 3003).

Complement to THIELE key design for slings with shortening components:

(key design as above)	+1 VK	shortening claw with pin coupling (TWN 0851)
"	+1 VE/VK	shortening device (TWN 0896)
"		plus shortening claws (TWN 0851)
"	+1 VH	shortening hook (TWN 0827)
"	+1 VE/VH	shortening device (TWN 0896)
"		plus shortening hook (TWN 0827)
"	+1 VHS	shortening with pin coupling (TWN 0827/1)
"	+1 VEA/VHS	shortening device (TWN 0896)
		plus shortening hook with pin coupling (TWN 0827/1)
		No. of shortenings (only 2 legs off)

THIELE Key Design

Table of available components for mounted chain slings

Master Link*	... TWN 1313	Intermediate Link*	... TWN 0795
Master Link for single leg w. Pin Coupling	... TWN 0820		
Suspension Shackle for Skips	... TWN 0869		
Chain Coupling Bolt Shackle	... TWN 0862	Special Chain Coupling Shackle	... TWN 0861
Special Coupling Shackle	... TWN 0897	Foundry or Container Hook with Pin Coupling	... TWN 0859
Foundry Hook Cont. or Cont. Eye Hook*	... TWN 0856	Ringshackle	... TWN 0812
Bolt Shackle*	... TWN 0871		
Sling Hook w. Pin Coupl. and Safety Latch	... TWN 1340/1	Eye Slip Hook with Safety Latch*	... TWN 0858/1
	... TWN 0835/1		
Self-locking Eye Hook*	... TWN 0798	Self-locking clevis Hook	... TWN 0799
Special Chain Shackle*	... TWN 0870	THI-LOK®	... TWN 1320
Shortening Hook with Pin Coupling	... TWN 0827	Swivel Hook with Latch*	... TWN 0854
Shortening Hook w. Pin Coupling a. Safety Latch	... TWN 0827/1	Chain Swivel*	... TWN 0845

*For complete Chain Slings with THI-LOK®-Connecting Links.



Endless Chains



Form K11



Form K12



Form K22

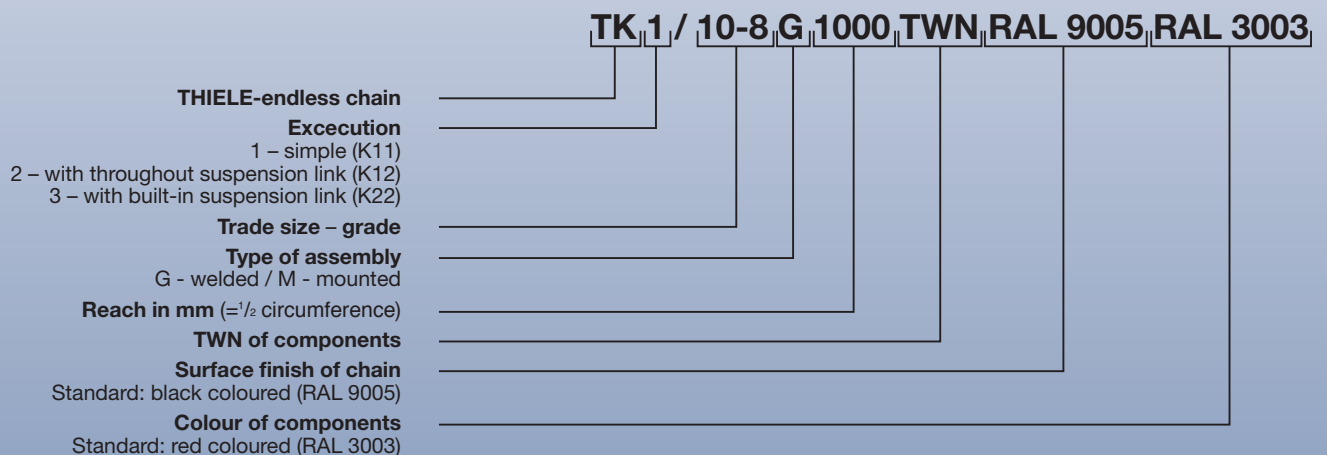

Please always indicate the THIELE key design in your order.

Example: TK 1 / 10-8 G 1000, RAL 9005 (K11-type with black coloured chain)















Examples for the THIELE Key Design

Type Sling	No. of Slings/ loops	Execution	Trade Size	Type of As-sembly	Reach [mm]	Component [TWN]	Surface Finish		Plant Standard [TWN]
							Chain [RAL-No.]	Components [RAL-No.]	
TA	1	A /	---	T	-----	1313	----	----	0449
TA	1	A /	---	T	-----	1340/1	----	----	0450/1
TA	1	A /	---	T	-----	0854	----	----	0454
TA	1	A /	---	T	-----	0856	----	----	0456
TA	1	A /	---	T	-----	0870	----	----	0458
TA	1	A /	---	T	-----	0871	----	----	0459
TA	1	A /	---	T	-----	0859	----	----	0460
TA	1	A /	---	T	-----	0861	----	----	0461
TA	1	A /	---	T	-----	0862	----	----	0462
TA	1	A /	---	T	-----	0858/1	----	----	0476/1
TA	2	A /	---	T	-----	1313	----	----	0529
TA	2	A /	---	T	-----	0835/1	----	----	0530/1
TA	2	A /	---	T	-----	0854	----	----	0534
TA	2	A /	---	T	-----	0856	----	----	0536
TA	2	A /	---	T	-----	0858/1	----	----	0566/1
TA	2	A /	---	T	-----	0870	----	----	0538
TA	2	A /	---	T	-----	0871	----	----	0539
TA	2	A /	---	T	-----	0859	----	----	0540
TA	2	A /	---	T	-----	0861	----	----	0541
TA	2	A /	---	T	-----	0862	----	----	0542
TK	1	1 /	---	M	-----	1313	----	----	0560
TA	2	A /	---	T	-----	1320	----	----	0563
TA	4	A /	---	T	-----	1314	----	----	0709
TA	4	A /	---	T	-----	1340/1	----	----	0710/1
TA	4	A /	---	T	-----	0854	----	----	0714
TA	4	A /	---	T	-----	0856	----	----	0716
TA	4	A /	---	T	-----	0858/1	----	----	0735/1
TA	4	A /	---	T	-----	0870	----	----	0718
TA	4	A /	---	T	-----	0871	----	----	0719
TA	4	A /	---	T	-----	0859	----	----	0720
TA	4	A /	---	T	-----	0861	----	----	0721
TA	4	A /	---	T	-----	0862	----	----	0722
TK	2	3 /	---	M	-----	1313	----	----	0731
TA	4	A /	---	T	-----	1320	----	----	0733



Examples for Chain Slings

1-Leg Chain Slings

<p>TWN 0449</p> 	<p>TWN 0450/1</p> 	<p>TWN 0453/1</p> 	<p>TWN 0454</p> 
<p>TWN 0456</p> 	<p>TWN 0458</p> 	<p>TWN 0459</p> 	<p>TWN 0460</p> 
<p>TWN 0461</p> 	<p>TWN 0462</p> 	<p>TWN 0473</p> 	<p>TWN 0475</p> 
<p>TWN 0477/1</p> 			





Examples for Chain Slings

2-Leg Chain Slings

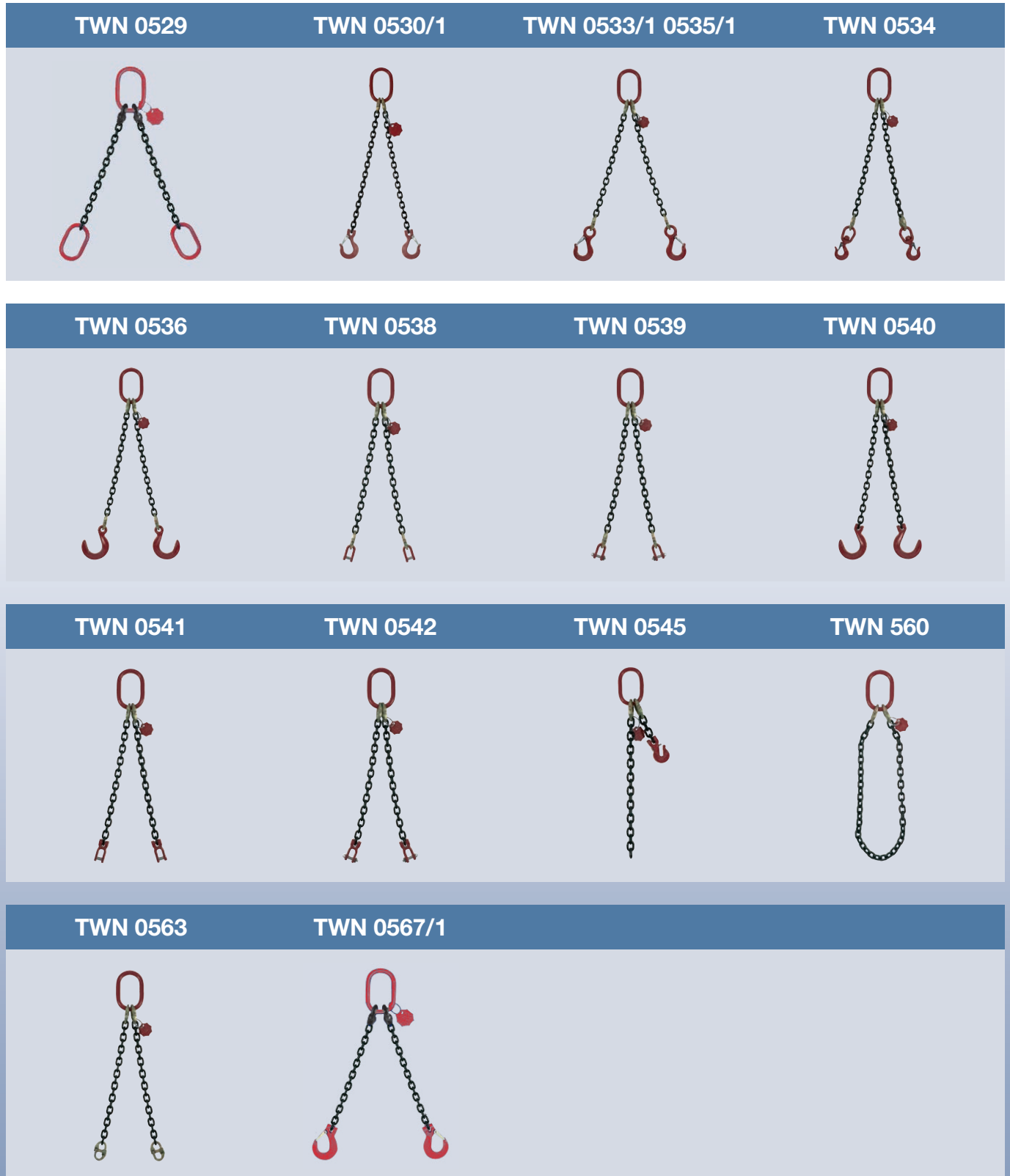

Examples for Chain Slings

4-Leg Chain Slings

TWN 0709



TWN 0710/1



TWN 0713/1 0715/1



TWN 0714



TWN 0716



TWN 0718



TWN 0719



TWN 0720



TWN 0721



TWN 0722



TWN 0730



TWN 0731



TWN 0733



TWN 0736/1





Offshore Products



In the offshore industry, chain slings are exposed to rough environmental conditions under strong dynamic loads. For this special application, THIELE as an authorized and certified manufacturer, supplies special calibrated welded-type chain slings as per DNV 2.7-1.

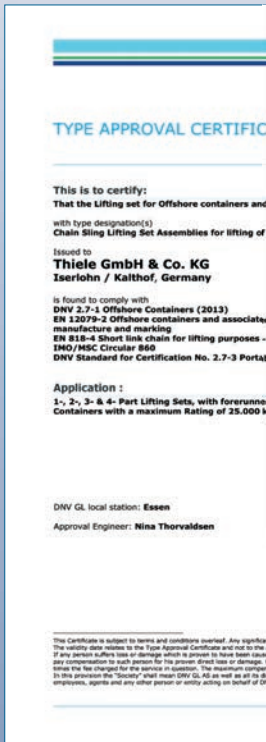
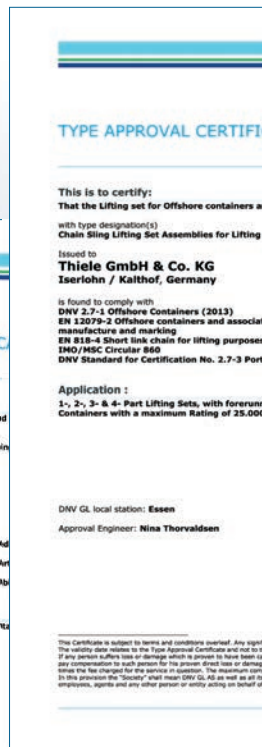

Operating Manual

WARNING!

- Sling Chains and Components can only be used, if user instructions and operating instructions have been read carefully and are completely understood.
- The indicated values of loads on the I.D. tags must not be exceeded.
- Due to improper use, chains can fail.

IT'S A QUESTION OF YOUR SAFETY
Death or injury can occur from improper use or maintenance!

1. Transport and Storing

All products must be protected during transportation, use, and storage in severe weather conditions.

2. Before first use

Assembling, disassembling and using should only be accomplished by authorized persons according to DGUV-R 100-500, Chapter 2.8 (in Germany)

Check the following points before using the chain sling for the first time:

- all test certificates exist (declaration of conformity, inspection certificate 3.1.B etc.); the chain sling you are going to use is the same that you ordered
- Slinging Chains and Tensioning Chains are provided with the CE label
- identification and working load limit marked on the chain sling are identical to the corresponding information indicated on the test certificate; all details concerning the chain sling have been entered into the chain card file
- The mounting is prohibited until it has been found out, that the machine in which should be built in, corresponds with the EC Directive for machines and its amendments (European rules and regulations).
- In suitable intervals, check the chain sling for damages or wear (depending upon severity of conditions slings shall be inspected for damage as frequently as prior to each lift. All supplied user instructions must be maintained and available for reference until the product is removed from service.

3. Warning and use advice

- EC Directive for Machines and its amendments as per 2006/42/EG
- Operation and use instructions for chain slings according to DIN 685 - Part 5, EN 818-6.
- Consult safety regulations for round steel chains used as slinging gear in hot dipped galvanizing plants (German rules and regulations) according to DGUV-R 109-004
- Consult Safety Regulations for Cranes according to DGUV52
- Consult load Suspension Devices for Lifting Operations (german rules and safety regulations) according to DGUV-R 100-500, Chapter 2.8
- Consult Safety certificate for riggers as per BGI 556
- Consult components for sling chains as per EN 1677-2
- Consult principles for test of industrial safety of lifting products
- Consult slinging of rod iron using steel round steel chains when loading and unloading sea-going ships
- Consult German rules and regulations VDI 2700-2701-2702

Special Components, hooks and clutching devices should only be used in straight tensile direction

Especially forbidden is:

- the combination of different grades when assembling (except tongs)
- the using of chain slings which do not correspond to grade 80
- overloading
- To use a combination of products with different working load limits, unless the working load noted on the I.D. tag is based on the weakest component.
- the use of twisted or knotted chains
- to use bolts or wires to connect components
- to use deformed components, rigid or elongated chains
- to lift or pull loads with sharp edges without padding the edges
- to drive equipment over chain sling
- to multiple wrap a chain around a loadhook or tension point
- to modify products by welding, burning, bending or other mechanical modifications
- to make inadmissible modifications, e.g. the use of a 2-leg sling chain with shortening hooks as a 4-leg sling chain
- to tip load a hook into a chain link
- to apply the load on the tip, side or back of the hook
- to load connectors (THI-LOK®) at one side
- to adjust chain links or products
- to adapt inclination over 60°
- to turn swivels or swivel hooks under load
- to weld Lifting Point screw type lifting eyes
- to exceed the indicated grip on lifting tongs
- the use of open or riveted repair links

It must be taken into consideration:

In the event that THIELE Chain and Components are used in an automated process, all parts should be designed correspondingly larger and inspected at more frequent intervals!

- the load to be lifted
- the free mobility of the hook's safety latches
- the use under chemical influences for example acids and steam is restricted or prohibited
- the influence of temperature on alloy chain and components
- shock load impacts the chain or fitting while lifting or securing
- any type of surface treatment to chain or fittings especially of hot dipped galvanizing can only be carried out by the manufacturer
- when lifting keep hands and other parts of body far away from the components
- be careful when locking hooks under load Danger of injury!
- when not in use sling chains must be hung on a rack
- ensure free mobility of chain slings or other devices in the crane hook
- when using hooks without latches pay special attention to the position of the hook placement
- to the installation position
- if necessary protect screw tensioners by locking elements to prevent automatic unlocking
- load claws with chains only on the bottom of the pocket claws
- protect chain by padding or wrapping sharp edges
- Safety latches should not be obstructed when hooks are loaded
- in case of shortening hooks, load chains must be loaded in the bowl of the hook
- hook openings must point away from the load being lifted
- that the hook up point and lifting hooks are compatible
- also be sure that the lifting components are suitable for the application

- do not sit loads on the chain sling
- reduction of working load limits is necessary when making lifts at severe angles
- consult charts when using alloy chain at extreme temperatures
- working load limits must be reduced when using endless and basket slings
- extreme caution should be used when using hooks for lifting molten metal or chemicals
- chain slings shall be loaded properly to avoid damage to chain and load
- keep personnel away from loads being lifted

4. Maintenance and tests

- The chain sling must be visually inspected before use. If damage is found, you must consult a chain expert according to DGUV-R 100-500.
- The product must be removed from service if the following damage is found:
 - unreadable tags
 - breaks or deformation
 - cuts, notches, grooves or cracks
 - strong corrosion
 - heating over the admissible temperature allowed
 - elongation of chain must not exceed 5% of manufacturer's published size
 - elongation of the overall chain length shall not exceed 5%
 - to determine wear rejection on the diameter of a link, you must measure the horizontal and the vertical and reject if reduction is more than 10%.
 - reject hooks if throat opening is opened greater than 10% of new hook or the safety latch does not seat properly
 - wear of hook eye or hook body exceed 5%
 - missing or damaged safety latch of the hook or shortening component
 - incorrect screw replacement on lifting eyes
 - incorrect or damaged bolts or turn off locking
- Don't repair chain slings yourself unless fully trained. Please contact the manufacturer or a repair expert. Use only original spare parts from THIELE.**

5. Regular inspections

Regular inspection shall include measurement and visual inspection and should be carried out once each year at minimum. Each third year inspection must include the crack detection (magna flux). On a new chain, you must set up chain card index that shall contain a description of the chain as well as the identity of the certificate. The inspection schedule must be fixed. The condition of sling chains or tensioning chains and their accessories must be noted at each inspection. If damage is repaired, all repairs and details must be noted on the chain card.

