



THIELE®



The Book 5.0

- > Lifting
- > Load Securing
- > Light Material Handling
- > Application Engineering

The **Name**
for **Safety.**



Quality and the Environment

Our principal objective consists of maximum customer satisfaction, the fulfilment of the high quality, environmental and safety requirements our products are subject to and the continuous, sustainable improvement of our processes. In line with these aims, THIELE introduced a quality management system in 1994 certified in accordance with ISO 9001, followed by an environmental management system certified in accordance with ISO 14001 in 2011. Further on, THIELE invested in efficient energy production and is certified acc. to the ISO 5001 Energy Management System and OSHAS 18001.

The long lifespan of our high quality products saves both on resources and the environment. This is why they have an excellent reputation among our international customers.

Customs

The increased globalisation and the changed global security situation have caused the EU to introduce the status of an "Authorised Economic Operator" (AEO) as a form of effective risk management within the customs administrations.

The aim is to secure the continuous global supply chain from the manufacturer to the end-user. The company THIELE has furnished proof that it is a reliable trading partner and it has already been in possession of an AEO certificate since 2010.

Content	Page
1. Information	2
2. THIELE Lifting Evolution	13
3. Lifting	15
3.1 THIELE Lifting Products Grade 100	15
3.2 THIELE Lifting Products Grade 80	59
3.3 THIELE Lifting Points	113
3.4 THIELE Hoist Chains	143
3.5 THIELE Hand Hoists (TM-Series)	153
4. Load Securing	163
4.1 THIELE Lashing Products	163
5. Light Material Handling	191
5.1 THIELE Conveyor Chains for Poultry Industry	191
5.2 THIELE Conveyor Chains for Farming	197
5.3 THIELE Chain Sprockets	201
6. Application Engineering	205
6.1 THIELE Stainless Steel Chains	205
6.2 THIELE Fishing Chains	209
6.3 THIELE Inspection Service	211
6.4 THIELE Customer Engineering	213





The Company

Company

As a chain manufacturer with our drop forge, THIELE is one of the leading companies of the chain industry worldwide. Customers appreciate our excellent technical problem solving skills concerning conveying and lifting applications as well as our high quality and functionality standards. Our products and services are strictly based on the expectations and needs of our customers and thus ensure a high level of customer satisfaction. Our brand is firmly positioned in all global business regions which strengthen your competitive position as well.





Development, CAD-Designs, Chain Dimensioning

The entire product development takes place in our in-house engineering department. Modern 3D-CAD programs support the designing of forged items and dies.

Precise volume calculations enable cost efficiency during the forging process. It is also possible to use 3D-CAD programs to simulate complicated hoist chain processes on chain sprockets.



Production

THIELE offers a very wide product range with more than 3000 products. It is possible to make an individual material selection as the forging takes place on our premises.

A consistent quality is ensured by the careful thermal treatment.



Service

A mobile testing service with qualified specialists offers on-site inspection of lifting products.

Upon request, we are able to carry out extensive tests on chain slings, components, round steel and load suspension devices.

THIELE Drop Forging

Forgings weighting between 0.1 kg and 60 kg, and measuring up to 1000 mm, are produced on three forging hammers – 31.5 kJ, 40 kJ and 100 kJ (10 kJ is equivalent to an impact energy of 1 tonne from a 1 m height of drop) – and a 1600-tonne forging press. The feedstock comprises square billets with edge lengths of between 20 and 120 mm or round billets 18.5 to 60 mm in diameter.

The material is first cut to size by cropping or sawing before the individual segments are heated in an induction unit assigned to the respective forging machine. The heated blanks are then reshaped in a die by means of pneumatically generated impact energy or by a forming force applied via a centrifugal mass. Finally, the flash is removed from the finished piece. The forming process often involves working to extremely very fine tolerances.

After forging the components undergo careful heat treatment in order to fine-tune their final properties.

At THIELE we make all our dies and trimming and forging tools in-house. We also employ program-controlled machines that can produce shapes using the latest technology, including high-speed cutting.



Forging with Quality Assurance

i

An experienced workforce combined with reliable production methods are the key to real quality assurance.

All key product characteristics are continuously monitored in a series of elaborate routines that are carried out at THIELE's in-house testing and laboratory facilities. This includes comprehensive crack testing of all forged components.

Benefits:

- FEM-optimised hook design
- anatomical profile
- drop forged according to grain direction
- accurate machining
- large range of types and product options





Contact Persons

Sales Service

Our experienced Sales Team is available for you during the working hours and can be reached by the following phone-numbers.

Address

Thiele GmbH & Co. KG
Werkstr. 3
DE-58640 Iserlohn
Germany

Working hours

Mo. – Th.: 8.00 – 16.30 h
Fr.: 8.00 – 16.00 h

Sales Director



Enrique Bermejo
Tel. +49 (0) 2371 947-312
e.bermejo@thiele.de

Domestic

Sales East Germany



Günter Dreier
Tel. +49 (0) 2371 947-232
g.dreier@thiele.de

Sales Middle of Germany



Patrick Jas
Tel. +49 (0) 2371 947-321
p.jas@thiele.de

Sales South Germany



Manfred Blach
Tel. +49 (0) 2371 947-225
m.blach@thiele.de

Sales North of Germany, Inspection Service



Nico Schütz
Tel. +49 (0) 2371 947-226
n.schuetz@thiele.de

Sales Germany



Teresa Fechner
Tel. +49 (0) 2371 947-225
t.fechner@thiele.de

Sales Germany



Alexandra Arndt
Tel. +49 (0) 2371 947-320
a.arndt@thiele.de



Domestic

Sales West Germany (Field Service)



Jörg Risse
Tel. +49 (0) 171 7639306
j.risse@thiele.de

Sales East Germany (Field Service)



Klaus Drechsel
Tel. +49 (0) 160 96902365
k.drechsel@thiele.de

Export

Sales Export Department



Heiko Kurz
Tel. +49 (0) 2371 947-223
h.kurz@thiele.de

Sales Export Department



Dominik Werth
Tel. +49 (0) 2371 947-204
d.werth@thiele.de

Sales Export Department



Lisa Temp
Tel. +49 (0) 2371 947-228
l.temp@thiele.de

Export



Stefanie Wenzel
Tel. +49 (0) 23 71 9 47-517
s.wenzel@thiele.de



Our Seminar Program



For increased safety when handling sling and lashing chains

Our experienced instructors train your employees as specialists and experts in sling technology and provide well-founded knowledge on the handling and use of sling and lashing chains.

We provide the following seminars:

1-Day Seminar (Training as a specialist for sling technology)

The seminar comprises:

- ▶ Chain and sling device studies
- ▶ Product instructions and instructions for use
- ▶ Wear behaviour and discard criteria for sling chains
- ▶ Material tests and metal studies concerning round link chains
- ▶ Sling components
- ▶ Technical properties of round steel chains and sling components
- ▶ Insight into the relevant standards
- ▶ Documentation and bibliography
- ▶ Participation certificate

2-Day Seminar (Training as an expert for sling technology)

After successful completion, the participants are qualified to test the sling technology in their company.

The seminar comprises in addition to the 1-day seminar following points:

- ▶ Instruction on Chapter 2.8 of GUV-R 500 (German occupational health insurance regulations)
- ▶ Instruction on EN 818, EN 1677, DIN 5692, etc.
- ▶ Product training
- ▶ Application examples
- ▶ Company tour
- ▶ Documentation and bibliography
- ▶ Participation certificate

Benefit from our manufacturers expertise and ask us for next seminar dates. We would be pleased to send you detailed written information.

Further information: <https://www.thiele.de/seminare.html>

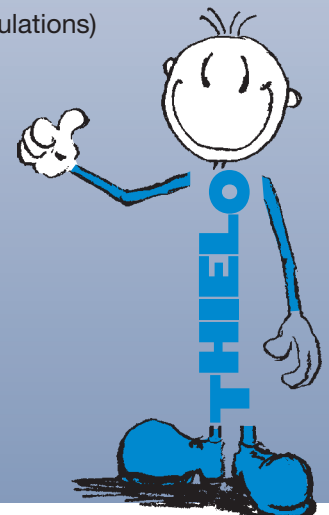



The THIELE-Book for Lifting Technology is available in the download center on our website.

i

The catalogue includes user information, geometry data and is a perfect support for your construction department.

The 3D-CAD data for the THIELE-Lifting Points Program are also available.



www.thiele.de



The THIELE Operating and Mounting Instructions for all Products are available in the download center on our website.

The operating and instruction manuals for all THIELE lifting products include all important information in regard to safety and operation in terms of the EG-guidelines and must be read before use. Please also take notice of the warning notices!



www.thiele.de/operating-manuals

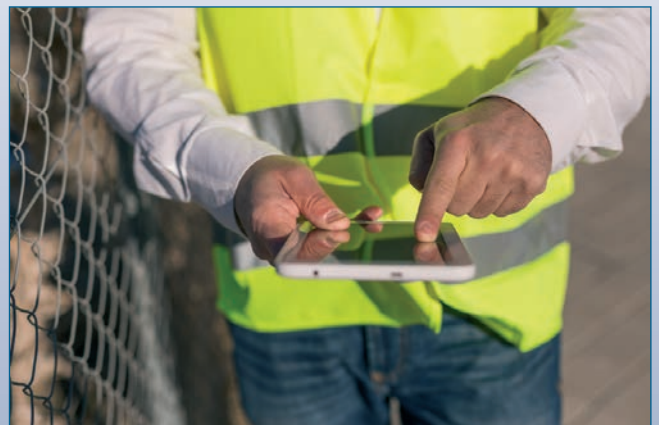

THIELE Sling Chain Configurator

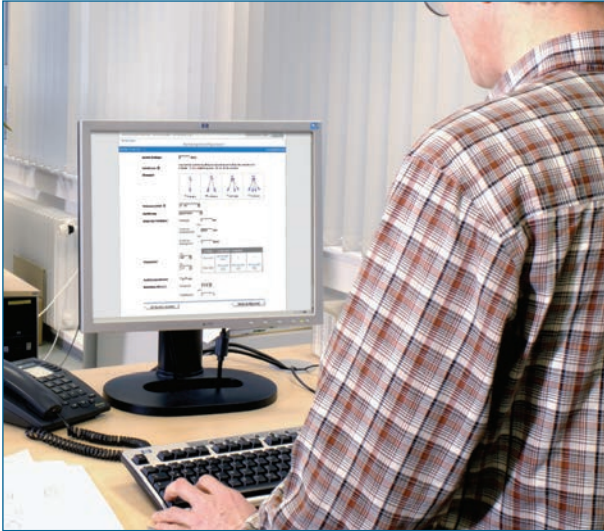

The **THIELE sling chain configurator and calculator** at the customer portal on our website simplify you considerably the offer configuration of sling chains.

You save time, eliminate error sources at the assignment of components, the addition of the part lengths and the summation of weights and costs.

Just upload your company data and your logo. Set up your customized offer under consideration of having regard to all commercial and technical aspects.

You get a structured offer with a detailed specification.

SERVICE at THIELE receives our utmost importance!

Please ask for your login data.





THIELE Lifting Evolution



is the new brand feature of THIELE.



All new THIELE products in Grade 100 and higher grades are developed with a new patented design.

The new corporate design ensures the characteristic differentiation of the brand THIELE. For more than 85 years, THIELE stands for durable reliability and for high value quality.

This added value for safety and certainty of THIELE-products for lifting purposes, now will be forged in ellipses style shaping.

Our experience of other products in use have shown that the assured product properties are not always being satisfied.

Standards are often being cited and not comprehensively fulfilled. The requirement of safety products for lifting are more than a determination of a breaking force.

Also the intensity of intermediate quality controls in the production make a large difference in the end result of the quality of the product.

Our motto: **“At THIELE you always know, what you get!”**

The new shaping with ellipses shall help as an orientation, particularly for the user.

Furthermore, the ellipses make our product modern and more dynamic. Lifting, moving and securing of loads can also be shapely.



At least, the ellipses of the components are only reflecting what a lot of our customers are already estimating on our products.

In particular our standard of quality. The result of years-long experience of controlled and safer sophisticated processes in the production **“MADE BY THIELE!”**

Not available on Connectors, Master Links, Round Steel Chains and Lifting Points.



Our Program



Lifting Products Grade 100



Lifting Products Grade 80



Lifting Points



Hoist Chains



Hand Hoists

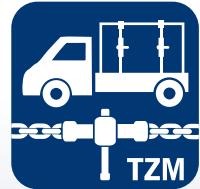

Lashing Products



Conveyor Chains for Poultry Industry



Conveyor Chains for Farming



Chain Sprockets



Stainless Steel Chains



Fishing Chains



Inspection Service



Customer Engineering











THIELE Lifting Products

Grade 100 (XL-Program)



Product Overview **THIELE** Lifting Products Grade 100

	<p>TWN 1805</p> 	<p>TWN 0072</p> 
<p>Page 28 – 29</p>	<p>Round Steel Link Chains</p>	

	<p>TWN 1813</p> 	<p>TWN 1814</p> 	<p>TWN 1815</p> 	<p>TWN 1795</p> 	<p>TWN 1810/1</p> 
	<p>TWN 1810/2</p> 	<p>TWN 1810/4</p> 	<p>TWN 1819</p> 		
<p>Page 30 – 34</p>	<p>Suspension Components</p>				

<p>Page 34</p>	<p>TWN 1820</p> 	
<p>Connector XL-LOK[®]</p>		

	<p>TWN 1836</p> 	<p>TWN 1837</p> 	<p>TWN 1840/1</p> 	<p>TWN 1841/1</p> 	<p>TWN 1856</p> 
<p>Page 35 – 37</p>	<p>Hooks</p>				



<p>TWN 1827</p> 	<p>TWN 1827/1</p> 	<p>TWN 1851</p> 	<p>TWN 1852</p> 	
<p>TWN 1896</p> 				

Page 37 – 40

Shortening Components



<p>TWN 1871</p> 	
---	--

Page 40

Shackles

<p>TWN 1454</p> 	<p>TWN 1455</p> 	
---	---	--

Page 41 – 42

Chain Tensioners



<p>TWN 1869</p> 	<p>TWN 1812</p> 	
<p>Page 43 – 44 Special Sling Components</p>		

<p>TWN 1410</p> 	<p>TWN 1411</p> 
<p>Page 44 – 45 Lashing Chains</p>	

<p>TWN 0944</p> 	<p>TWN 0945</p> 	<p>TWN 1402</p> 	<p>TWN 1904/0</p> 	<p>TWN 1908/0</p> 
<p>TWN 1921</p> 	<p>TWN 1930/0</p> 	<p>TWN 1931/0</p> 	<p>TWN 1933/0</p> 	<p>TWN 1935</p> 
<p>TWN 1950</p> 	<p>TWN 1951</p> 	<p>TWN 1940</p> 	<p>TWN 1946</p> 	<p>TWN 0968</p> 
<p>TWN 0969</p> 				
<p>Page 45 – 50 Spare Parts and Accessories</p>				



TWN 1601/1-Leg



TWN 1651/2-Leg



TWN 1751/4-Leg



Page
51 – 55

Chain Slings



Page
56

Shortening Options

Form K11



Form K12



Form K22



Page
57

Endless Chains



Comparison between Grade 80 and Grade 100

Grade 100 – up to 30% weight reduction on a 2-Leg Chain Sling compared to equivalent Grade 80 Sling.

Article	THIELE Plant Standard	Pieces
Master Link	TWN 1813	1
XL-LOK®	TWN 1820	2
2 m Round Steel Link Chain	TWN 1805	2
Clevis Sling Hook	TWN 1840/1	2

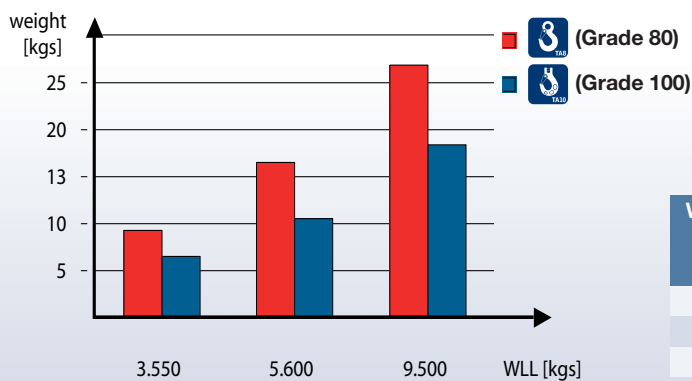

Working Load Limit [t max.]	TA8 Weight [kgs]	TA10 Weight [kgs]	Weight-reductions [%]
3,55	9,3	6,5	30
5,60	16,5	10,6	35
9,00	26,8	18,4	31

Properties	Grade	TA8	TA10 – XL400
Working Load Limit (WLL)			25 % stronger
Safety Factor	4		4 (-7 %)
Elongation at break (completed finish)	min. 20 %		min. 20 %
Weight			app. 30 % less
Nominal Size			same as Grade 80
Breaking Stress	min. 800 N/mm ²		min. 1000 N/mm ²
Component Strength	1150-1250 MPa		1450-1550 MPa
Load Factor	acc. to catalogue		same as GK8
Temperature Application Range	-40 – 200 °C (100 %) ¹⁾ 200 – 300 °C (90 %) ¹⁾ 300 – 400 °C (75 %) ¹⁾		-30 – 200 °C (100 %) ¹⁾ 200 – 300 °C (90 %) ¹⁾ 300 – 380 °C (60 %) ¹⁾
Asymmetry Factor	acc. to catalogue		same as Grade 80
Acids and Lyes	not allowed		not allowed
Compatibility with other system	possible		restricted
Colour Round Steel Link Chains (AQUA lacquer)	black painted (RAL 9005)		ultramarine blue painted (RAL 5002)
Colour Forgings	powder painted red (RAL 3003)		ultramarine blue powder painted (RAL 5002)
Standards	European and International		PAS 1061 (Manufactures Recommendation)
Life cycle			less wear

¹⁾ Related to nominal Working Load Limit.



Selection Criteria for Chain Slings

1. Determine the **weight of the load** to be lifted.
2. Check **number of chain-legs** required (depending on the numbers of existing lifting points).
3. Determine the **trade size** by taking the **inclination angle** into consideration
(see table 1 on page 25 and table 2 and 3 on page 26).
4. Consider possible (extreme) **temperature influences** (see special advices page 27).
5. Consider that **asymmetry** may influence the load factor (see table 4 on page 27).
6. Choose the **master links, shortening elements** and **components** suitable for the selected chain trade size.
7. Determine the **chain length** by considering the total effective reach.
8. Control (inspect) selected components and/or in-use chain slings to ensure that they meet or exceed all applicable industry and government safety-laws and regulations (acc. to DGUV).



Special Advices:

Please also consider more complicated conditions of use, such as intermittent impacts or loads when selecting the Grade 100 slings and/or components. The maximum application temperature for Grade 100 products must be taken into consideration. If the slings were used above the maximum temperature, then they have to be immediately rejected. Please contact the manufacturer. The THIELE-assembly system must not be used in the case of chemical influences such as acids and/or lyes.

THIELE Plant Standard (TWN)

THIELE plant standard fulfills the requirements of the EG-directive for machines, particularly for the safety relevant components. The working load limit and the test requirements meet or exceed the European standards.



Chain Inspection Gauge



Inspection of material diameter



Inspection of permanent elongation



Pitch inspection

Material diameter

Pitch inspection

Front side

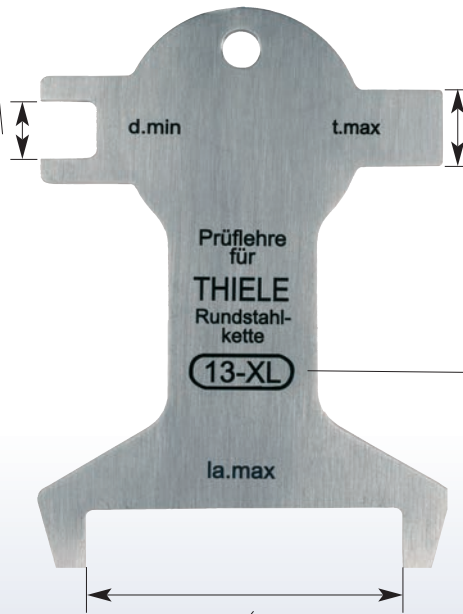

Inspection of permanent elongation

Back side



Identification Tag

The use of a chain sling without identification tag is permitted.

The data on the identification tag are in accordance to the EN 818-4 for chain slings. The THIELE Grade 100 identification tag differs particularly by shape (decagon) and colour (RAL 5002) from other Grades.

Front side



Back side

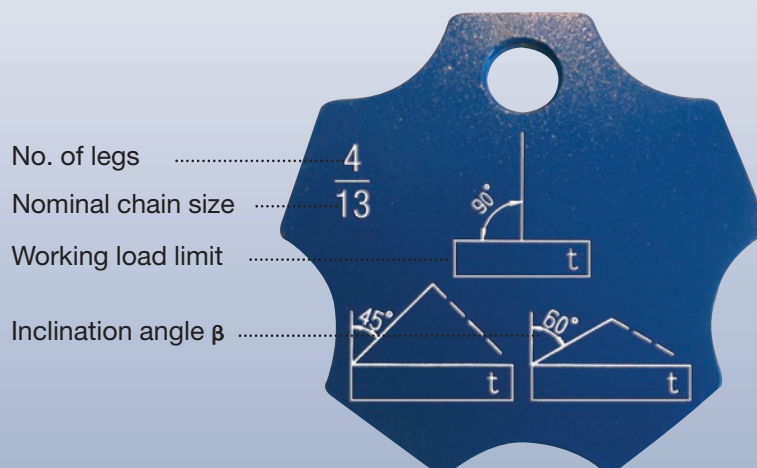

Legal Marking of Grade 100 Chains by the German DGUV

The number 4 under the \mathcal{H} represents a registration number of the German statutory accident insurance (DGUV) and helps to identify/locate the manufacturer in case of damage. The marking is also recognized by all international certification societies as well as by work authorities etc., among others the A. I. B. in Brussels.



Liability, Assembly, Material



From the DGUV-approved Round Steel Link Chains and Components **XL-400** are stamped with »10«, »XL-400«, »Germany« and a traceability code.

Round Steel Link Chains **XL-200** are stamped with »T3-10«, »XL-200«, »Germany« and traceability code.

TA10-chains are only allowed to couple with original **TA10**-Components of the corresponding Trade Size.

Liability

THIELE does not take any type of liability if **TA10**-Components are combined with other manufacturers' products.

Assembly

The combination of different Grades is prohibited.

Only use original THIELE spare parts.

Material

For the production of Grade **TA10**, only High Alloy Steels according to DIN 17115 are used.

Working Load Limit Tables

Working Load Limit – Type: Direct Slings

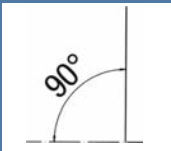
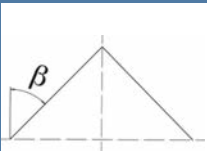
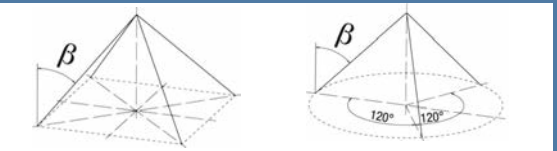
		1-Leg	2-Leg		3- and 4-Leg	
						
Inclination Angle		$\beta = 0^\circ$	$0^\circ < \beta \leq 45^\circ$	$45^\circ < \beta \leq 60^\circ$	$0^\circ < \beta \leq 45^\circ$	$45^\circ < \beta \leq 60^\circ$
Load Factor		1	1,4	1	2,1	1,5
Trade Size	Nominal Size [mm]	[t max.]	[t max.]	[t max.]	[t max.]	[t max.]
6-10	6	1,40	2,00	1,40	3,00	2,12
8-10	8	2,50	3,55	2,50	5,30	3,75
10-10	10	4,00	5,60	4,00	8,00	6,00
13-10	13	6,70	9,00	6,70	14,00	10,00
16-10	16	10,00	14,00	10,00	21,20	15,00
20-10*	20	16,00	22,40	16,00	33,50	23,60
22-10	22	19,00	26,50	19,00	40,00	28,00
26-10*	26	26,50	37,50	26,50	56,00	40,00
32-10*	32	40,00	56,00	40,00	85,00	60,00



Note: THIELE chain slings are available in mounted and welded execution.

*These chain slings are only available in welded execution.

Table 1

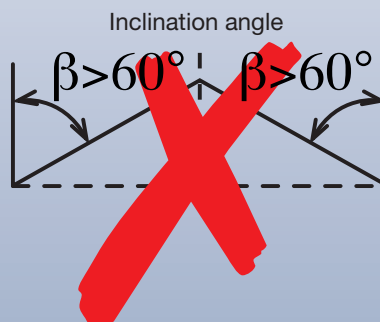

Safety Notice:

Can fail if damaged, misused or overloaded. Inspect before use. Use only if trained. Observe rated capacity in tables 1, 2, 3. DEATH or INJURY can occur from improper use or maintenance.



Working Load Limit Tables

Working Load Limit – Type: Choke Hitch

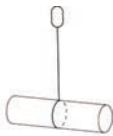
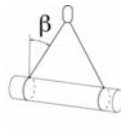
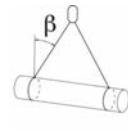
		1-Leg	2-Leg	3- and 4-Leg
				
Inclination Angle β		$\beta = 0^\circ$	$0^\circ < \beta \leq 45^\circ$	$45^\circ < \beta \leq 60^\circ$
Load Factor		0,8	1,12	0,8
Trade Size	Nominal Size [mm]	[t max.]	[t max.]	[t max.]
6-10	6	1,12	1,60	1,12
8-10	8	2,00	2,80	2,00
10-10	10	3,15	4,50	3,15
13-10	13	5,30	7,50	5,30
16-10	16	8,00	11,20	8,00
20-10	20	12,50	18,00	12,50
22-10	22	15,00	21,20	15,00
26-10	26	21,20	30,00	21,20
32-10	32	31,50	45,00	31,50

Note: Inclination angles β over 60° are prohibited.

Table 2

Working Load Limit – Type: Endless Chain

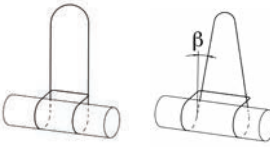
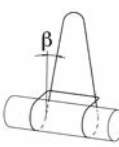
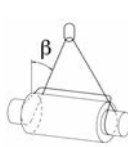
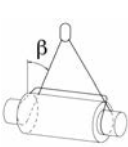
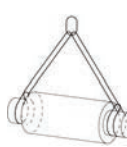
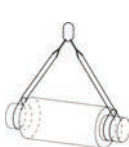
		K11		K12	K13	K22	K23
							
Inclination Angle β		$\beta = 0^\circ$	$0^\circ < \beta \leq 25^\circ$	$0^\circ < \beta \leq 45^\circ$	$45^\circ < \beta \leq 60^\circ$	$0^\circ < \beta \leq 45^\circ$	$45^\circ < \beta \leq 60^\circ$
Load Factor		1,6	1,45	1,12	0,8	1,7	1,2
Trade Size	Nominal Size [mm]	[t max.]	[t max.]	[t max.]	[t max.]	[t max.]	[t max.]
6-10	6	2,24	2,00	1,60	1,12	2,36	1,70
8-10	8	4,00	3,55	2,80	2,00	4,25	3,00
10-10	10	6,30	5,60	4,50	3,15	6,70	4,75
13-10	13	10,60	9,50	7,50	5,30	11,20	8,00
16-10	16	16,00	14,00	11,20	8,00	17,00	11,80
20-10	20	25,00	22,40	18,00	12,50	26,50	19,00
22-10	22	30,00	28,00	21,20	15,00	31,50	22,40
26-10	26	42,50	37,50	30,00	21,20	45,00	31,50
32-10	32	63,00	56,00	45,00	31,50	67,00	47,50

Note: Inclination angles β over 60° are prohibited.

Table 3



Type of Endless Chains

Type K11



Type K12

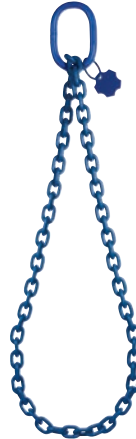

Type K22



Load Reductions

Temperature Application Range

Round Steel Link Chains **XL-200** (acc. to ASTM 973)

Temperature Application Range	W.L.L.
-20°C to 205°C	100 %

Round Steel Link Chains **XL-400** (acc. to PAS 1061)

Temperature Application Range	W.L.L.
-30°C to 200°C	100 %
over 200°C to 300°C	90 %
over 300°C to 380°C	60 %

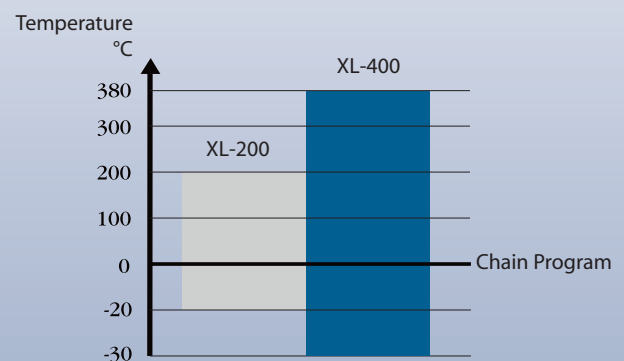

Load Factor at Asymmetry

No. of Legs	1		2		3		4			
	Inclination Angle β	Load Factor	Inclination Angle β	Load Factor	Inclination Angle β	Load Factor	Inclination Angle β	Load Factor		
	-	1	0° – 45°	1	46° – 60°	1	0° – 45°	1,4	46° – 60°	1

Table 4



Product Features

Round Steel Link Chains TWN 1805 acc. to PAS 1061 **XL-400**



Trade Size	Article-No.	Nom. Size d [mm]	Pitch p [mm]	Pitch Tol. ± [mm]	Inside Width w ₁ [mm min.]	Outside Width w ₂ [mm max.]	Working Load Limit [t max.]	Weight app. [kgs/m]
6-10	F01610B	6	18	0,5	7,80	22,20	1,40	0,9
8-10	F01615B	8	24	0,7	10,92	29,60	2,50	1,6
10-10	F01622B	10	30	0,9	13,00	37,00	4,00	2,5
13-10	F01629B	13	39	1,2	17,48	48,10	6,70	4,3
16-10	F01635B	16	48	1,4	20,80	59,20	10,00	6,5
20-10	F01638B	20	60	1,8	26,00	74,00	16,00	10,1
22-10	F01650B	22	66	2,0	28,60	81,40	19,00	12,3
26-10	F01660B	26	78	2,3	33,80	96,20	26,50	17,1
32-10	F01670B	32	96	2,9	41,60	118,40	40,00	23,0

New

Coated with environmentally friendly AQUA-chain lacquer (RAL 5002).





Round Steel Link Chains TWN 0072 acc. to ASTM 973 **XL-200**

Trade Size	Article-No.	Nom. Size d [mm]	Pitch p [mm]	Pitch Tol. ± [mm]	Inside Width w ₁ [mm min.]	Outside Width w ₂ [mm max.]	Working Load Limit [t max.]	Weight app. [kgs/m]
6-10	F01616	6	18	0,5	7,95	22,20	1,40	0,9
7-10	F01621	7	21	0,7	9,53	25,90	2,00	1,2
8-10	F01617	8	24	0,7	10,92	29,60	2,60	1,6
10-10	F01618	10	30	0,9	13,00	37,00	4,00	2,5
13-10	F01619	13	39	1,2	17,48	48,10	6,80	4,1
16-10	F01620	16	48	1,4	20,63	59,20	10,30	6,2



Coated with environmentally friendly AQUA-chain lacquer (RAL 7011).

Comparison between Round Steel Link Chains **XL-400** and **XL-200**

Properties	Chain Type	XL-400	XL-200
Standard		PAS 1061	ASTM 973
Material		higher alloyed steel	alloyed steel
Temperature application range		-30°C up to 380°C; reduction starting from 200°C	-20°C up to 205°C
Working Load Limit (WLL)		25% higher than Grade 80	25% higher than Grade 80
Manufacturers Proof Force (MPF)		min. 2,5 x WLL	min. 2 x WLL
Breaking Force (BF)		min. 4 x WLL; up to 7% reduction allowed	min. 4 x WLL
Elongation at break (completed finish)		min. 20%	min. 20%
Charpy Notch Value		min. 42J at -20°C	min. 36J at -20°C
Deflection		min. 0,8 x d	min. 0,8 x d
Fatigue		min. 20.000 LC	no requirements
Material properties (stress corrosion)		according to standard	no requirements
Finish		Galvanizing prohibited	Galvanizing prohibited
Colour (solvent-free)		RAL 5002	RAL 7011
Marking		Ⓢ -10, XL-400, Germany, ID#	T3-10, XL-200, Germany, ID#
Certification		DGUV	THIELE



Suspension Components



New The **Master Link Form A TWN 1813**

according to DIN 5688 for 1- and 2-leg chain slings enables an easy assembly of a connecting link **XL-LOK**® TWN 1820. This way of coupling offers a higher flexibility in assembling of chain slings with the advantage of less stock inventory. Further on, the links acc. to EN 1677-4 may be used as components e.g. on steel wire rope slings acc. to DIN EN 13414-1.

Trade Size		Article-No.	Working Load Limit [t max.]	Dimensions [mm]			Weight app. [kgs]
1-Leg	2-Leg			D	F	B	
6 (7)	6	F1813013	2,50	13	90	50	0,30
8	(7)	F1813016	4,00	16	110	60	0,50
10	8	F1813018	5,00	18	130	70	0,79
-	10	F1813020	6,00	20	140	80	1,24
13	-	F1813022	7,10	22	160	90	1,50
16	13	F1813026	10,00	26	180	100	2,33
18	16	F1813032	15,00	32	230	125	4,40
22	18	F1813036	20,00	36	250	140	6,20
-	20	F1813040	23,60	40	290	160	8,80
26	22	F1813045	30,00	45	320	175	12,00
32	26	F1813050	40,00	50	340	190	16,00
-	-	F1813056	50,00	56	380	210	23,00
-	32	F1813063	60,00	63	430	240	33,00
-	-	F1813070	75,00	70	470	260	44,00

Note: The TWN 1813 replaces the TWN 1807 and TWN 1808.
Rated for 2-leg chain slings use with inclination angle $0^\circ < \beta \leq 45^\circ$.

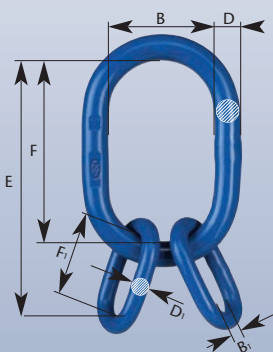

New The **Master Link Assembly TWN 1814**

according to DIN 5688 for 3- and 4-leg chain slings enables easy assembling of a **XL-LOK**® TWN 1820. Further on, the links acc. to EN 1677-4 may be used as components e.g. on steel wire rope slings acc. to DIN EN 13414-1.

Trade Size	Article-No.	Working Load Limit $0^\circ < \beta \leq 45^\circ$ [t max.]	Dimensions [mm]							Weight app. [kgs]
			E	D	F	B	D ₁	F ₁	B ₁	
6-10	F1814016	4,00	170	16	110	60	13	60	30	1,00
8-10	F1814020	6,00	210	20	140	80	16	70	35	1,80
10-10	F1814026	10,00	270	26	180	100	20	90	45	3,80
13-10	F1814032	15,00	350	32	230	125	26	120	60	7,70
16-10	F1814040	23,60	420	40	290	160	28	130	65	13,00
22-10	F1814050	40,00	520	50	340	190	40	180	90	28,00
26-10	F1814063	60,00	630	63	430	240	45	200	100	49,00
32-10	F1814080	85,00	740	80	520	290	50	220	110	86,00

Note: The TWN 1814 replaces the TWN 1809.



Suspension Components

The **Master Link Assembly TWN 1815**

according to EN 13414-1 is designed for 3- and 4-leg wire rope slings. Dimensionally the links comply with the DIN 5688-3. The fracture mechanics are according to EN 1677-1 and EN 1677-2.

The special enlarged intermediate links enable a simple assembly of steel and fiber wire rope slings.

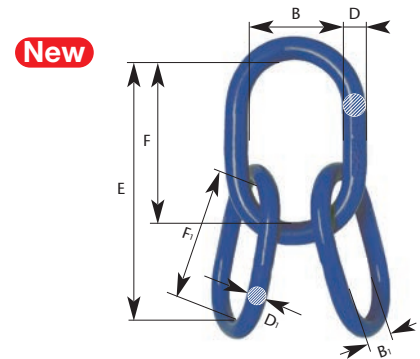

Article-No.	Working Load Limit 0° $\beta \leq 45^\circ$ [t max.]	Dimensions [mm]							Categorization of the Wire Rope Diameter*		Weight app. [kgs]
		E	D	F	B	D ₁	F ₁	B ₁	Fiber Rope [mm]	Steel Rope [mm]	
F1815016	3,50	200	16	110	60	13	90	50	12,00	11,00	1,10
F1815018	5,00	240	18	130	70	16	110	60	14,00	14,00	1,90
F1815022	6,00	290	22	160	90	18	130	70	16,00	16,00	3,10
F1815026	9,30	340	26	180	100	22	160	90	20,00	18,00	5,30
F1815032	13,90	410	32	230	125	26	180	100	24,00	22,00	9,00
F1815036	20,00	480	36	250	140	32	230	125	28,00	28,00	15,00
F1815045	26,30	570	45	320	175	36	250	140	32,00	32,00	24,00
F1815050	40,00	660	50	340	190	45	320	175	40,00	40,00	40,00
F1815056	50,20	720	56	380	210	50	340	190	44,00	44,00	55,00
F1815063	62,60	810	63	430	240	56	380	210	52,00	48,00	79,00
F1815085	127,20	1040	85	520	290	80	520	290	60,00	60,00	200,00

*According to DIN EN 13414-1 for 3- and 4-leg wire rope slings.

The **Intermediate Master Link Type B TWN 1795**

according to DIN 5688-3 enables assembling of a **XL-LOK**® and other components. The working load limit as well as the manufacturers' and proof requirements are based on the standard DIN EN 1677-1 and DIN EN 1677-4 considering a 25% higher working load limit.

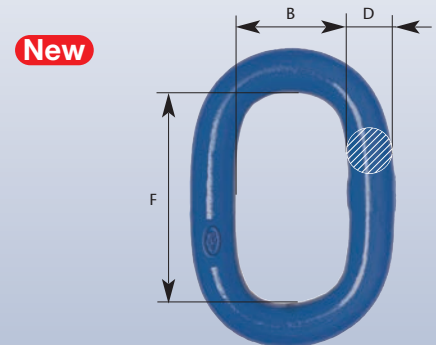

Trade Size	Article-No.	Working Load Limit [t max.]	Dimensions [mm]			Weight app. [kgs]
			D	F	B	
B8	F179508	1,40	8	36	18	0,05
B10	F179510	2,50	10	46	23	0,09
B13	F179513	4,00	13	60	30	0,20
B16	F179516	6,70	16	70	35	0,36
B20	F179520	10,00	20	90	45	0,73
B22	F179522	12,50	22	100	50	0,97
B26	F179526	16,00	26	120	60	1,60
B28	F179528	19,00	28	130	65	1,90
B32	F179532	26,50	32	140	70	2,90
B36	F179536	31,30	36	160	80	4,20
B40	F179540	40,00	40	180	90	5,80
B45	F179545	50,00	45	200	100	8,20



Suspension Components



The Fixed Size Master Link Assembly TWN 1810/1

Type TAA1 for 1-leg chain slings is automatically determined to the trade size of the ringshackle. The ringshackle moves freely. A welded identification tag contains all the necessary data required. The dimensions are in accordance with DIN 5688, form A. The fixed size master link assembly type TAA1 can also be delivered without the ringshackle as a master link TWN 1813.

Trade Size	Article-No.	Working Load Limit [t max.]	Dimensions [mm]				Suitable for Crane Hooks acc. DIN 15401 [No.]	Weight app. [kgs]
			E	D	F	B		
6-10	F1810106	1,40	121	13	90	50	1,6	0,40
8-10	F1810108	2,50	147	16	110	60	2,5	0,71
10-10	F1810110	4,00	176	18	130	70	4	1,21
13-10	F1810113	6,70	219	20	140	80	6	2,33
16-10	F1810116	10,00	256	22	160	90	8	3,90



The Fixed Size Master Link Assembly TWN 1810/2

Type TAA2 for 2-leg chain slings is automatically determined to the trade size of the ringshackle. The ringshackle moves freely. A welded identification tag contains all the necessary data required. The dimensions are in accordance with DIN 5688, form A. The fixed size master link assembly type TAA2 can also be delivered without the ringshackle as a master link TWN 1813.

Trade Size	Article-No.	Working Load Limit $0^\circ < \beta \leq 45^\circ$ [t max.]	Dimensions [mm]				Suitable for Crane Hooks acc. DIN 15401 [No.]	Weight app. [kgs]
			E	D	F	B		
6-10	F1810206	2,00	121	13	90	50	1,6	0,50
8-10	F1810208	3,55	167	18	130	70	4	1,20
10-10	F1810210	5,60	186	20	140	80	5	1,90
13-10	F1810213	9,00	239	26	180	100	8	4,00
16-10	F1810216	14,00	296	32	230	125	12	7,60



Suspension Components

The Fixed Size Master Link Assembly TWN 1810/4

Type TAA4 for 3/4-leg chain slings is automatically determined to the trade size of the ringshackle. The ringshackle moves freely. A welded identification tag contains all the necessary data required. The dimensions are in accordance with DIN 5688, form A. The fixed size master link assembly type TAA4 can also be delivered without the ringshackle as a master link TWN 1814.

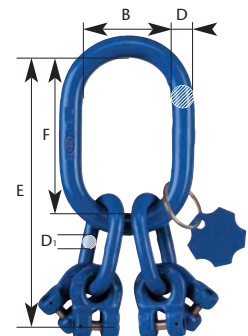

Trade Size	Article-No.	Working Load Limit $0^\circ < \beta \leq 45^\circ$ [t max.]	Dimensions [mm]					Suitable for Crane Hooks acc. DIN 15401 [No.]	Weight app. [kgs]
			E	D	F	B	D ₁		
6-10	F1810406	3,00	201	16	110	60	13	2,5	1,40
8-10	F1810408	5,30	247	20	140	80	16	5	2,70
10-10	F1810410	8,00	316	26	180	100	20	8	5,40
13-10	F1810413	14,00	409	32	230	125	26	12	11,20
16-10	F1810416	21,20	495	40	290	160	28	20	19,40





Suspension Components

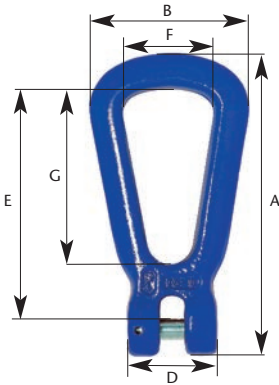

New The **Master Link with Pin Coupling TWN 1819** is suitable to be used for single leg slings for bundling of e.g. rod material. The compact design enables an easy handling. The special shape makes the THIELE-original unique.

100% magnetic crack-tested.

DGUV-approved.

Trade Size	Article-No.	Working Load Limit [t max.]	Dimensions [mm]								Weight app. [kgs]
			A	B	C	D	E	F	G	H	
13-10	F31025	6.70	189	102	32	60	142,5	60	110	22	1,09

XL-LOK® Connector

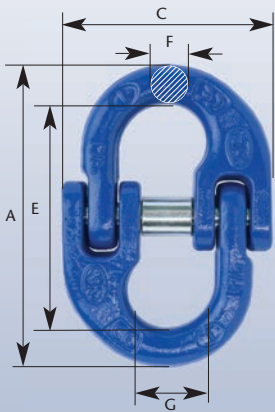

Connecting Link **XL-LOK®** TWN 1820

XL-LOK® Connecting Links according to THIELE plant standard (TWN) are designated for safe lifting, moving and slinging of weights. Working load limits and product requirements are based on the EN 1677-1, taking a 25% higher working load limit into account. Spare parts are available according to TWN 1921.

100% magnetic crack-tested.

DGUV-approved.

Trade Size	Article-No.	Working Load Limit [t max.]	Dimensions [mm]					Weight app. [kgs]
			E	G	A	C	F	
6-10	F30807	1,40	45,0	14,0	61,0	38,5	7,6	0,07
8-10	F30817	2,50	62,0	19,0	85,0	55,0	10,0	0,20
10-10	F30827	4,00	72,0	23,8	97,2	65,5	12,6	0,35
13-10	F30837	6,70	87,3	28,0	125,3	82,5	16,7	0,74
16-10	F30847	10,00	105,0	34,3	146,2	109,0	20,6	1,16
22-10	F30861	19,00	140,0	47,3	193,0	132,5	26,0	3,30

New

Hooks

The Eye Self-Locking Hook TWN 1836

automatically locks at load. The flattened extra large eye offers universal coupling options. A robust trigger at the back side of the hook can be easily hand-operated. Despite an extra wide hook-opening, the eye self-locking hooks offer a slim shape and enable a versatile use. The special shape makes the THIELE-original unique.

The available trigger sets are universal for hooks type TWN 1836 and 1837.

100% magnetic crack-tested.

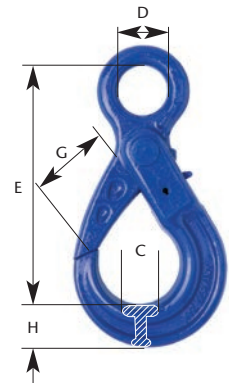

Trade Size	Article-No.	Working Load Limit [t max.]	Dimensions [mm]					Weight app. [kgs]
			E	D	G	H	C	
6-10	F092203	1,40	110	21	28	20	15	0,50
8-10	F092213	2,50	137	27	35,5	26	20	0,80
10-10	F092223	4,00	169	34,5	45	30	26	1,50
13-10	F092233	6,70	209	40	53,5	40,5	32,5	3,00
16-10	F092243	10,00	254	50	62	50,5	38	6,00
New 22-10	F092273	19,00	319,5	70	80	66	52	11,74

The Clevis Self-Locking Hook TWN 1837

automatically locks at load. A robust trigger at the back side of the hook can be easily hand-operated. Despite an extra wide hook-opening, the clevis self-locking hooks offer a slim shape and enable a versatile use. The special shape makes the THIELE-original unique.

The available trigger sets are universal for Hooks type TWN 1836 and 1837.

100% magnetic crack-tested.

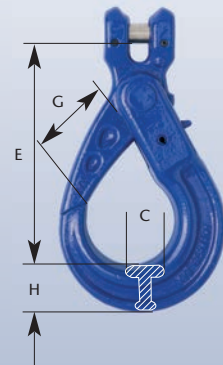

Trade Size	Article-No.	Working Load Limit [t max.]	Dimensions [mm]				Weight ca. [kgs]
			E	G	H	C	
6-10	F092002	1,40	96	28	20	15	0,50
8-10	F092012	2,50	123	35,5	26	20	0,90
10-10	F092022	4,00	144	45	30	26	1,50
13-10	F092032	6,70	182	53,5	40,5	32,5	3,00
16-10	F092042	10,00	217	62	50,5	38	5,90
New 22-10	F092072	19,00	276,5	80	66	52	12,31



Hooks

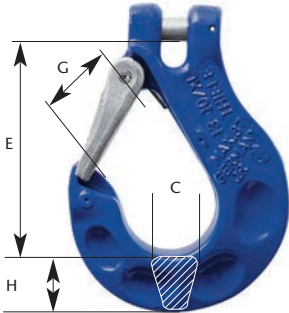

The Clevis Sling Hook TWN 1840/1

with its heavy-duty forged safety latch and its clevis is designed to the corresponding trade size. The forged measurement points and maximum admissible values allow an easy inspection of the hook-opening. The safety latch is protected by wear edges on the hook body. Additionally, the safety latch has a fixed position due to the forged seat at the tip of the hook. The special shape makes the THIELE-original unique.

100% magnetic crack-tested.

DGUV-approved.

Trade Size	Article-No.	Working Load Limit [t max.]	Dimensions [mm]				Weight app. [kgs]
			E	G	H	C	
6-10	F336050	1,40	75	24	20	17	0,36
8-10	F336150	2,50	92	30	25	22	0,75
10-10	F336250	4,00	113	37	32	28	1,40
13-10	F336350	6,70	133	42	41	35	2,50
16-10	F336450	10,00	162	51	50	41	4,40

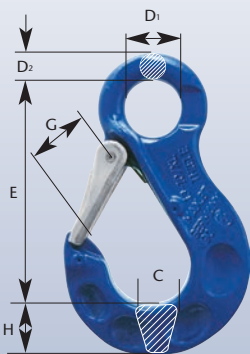

The Eye Sling Hook TWN 1841/1

with its heavy-duty forged safety latch and its eye is designed to the corresponding trade size. The flattened extra large eye offers universal coupling options. The forged measurement points and maximum admissible values allow an easy inspection of the hook-opening. The safety latch is protected by wear edges on the hook body. Additionally, the safety latch has a fixed position due to the forged seat at the tip of the hook. The special shape makes the THIELE-original unique.

100% magnetic crack-tested.

DGUV-approved.

Trade Size	Article-No.	Working Load Limit [t max.]	Dimensions [mm]						Weight app. [kgs]
			E	D ₁	D ₂	G	H	C	
6-10	F32905	1,40	91	21	11	24	20	17	0,36
8-10	F32915	2,50	118	28	14	30	25	22	0,78
10-10	F32925	4,00	145	36	18	37	32	28	1,50
13-10	F32935	6,70	168	42	21	42	41	35	2,55
16-10	F32945	10,00	210	54	25	51	50	41	4,65
22-10	F32975	19,00	271	65	30	70	62	54	9,77
26-10	F32985	26,50	302	70	33	75	71	59	14,20 New

Hooks

The Eye Foundry Hook TWN 1856

has been optimized in its shape. Working load limits and product requirements are based on the EN 1677-1, taking a 25 % higher Working load limit into account. The special shape makes the THIELE-original unique.

100% magnetic crack-tested.

DGUV-approved.

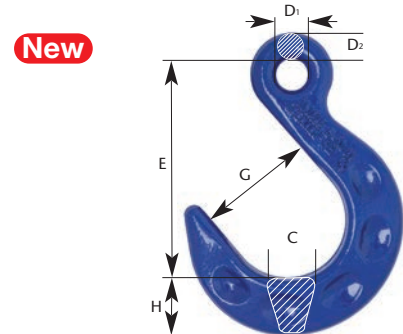

Trade Size	Article-No.	Working Load Limit [t max.]	Dimensions [mm]						Weight app. [kgs]
			E	D ₁	D ₂	G	H	C	
6-10*	F32355	1,40	95	21	12	50	25,1	19,5	0,42
8-10	F32365	2,50	125	28	14,5	66	33	26	0,92
10-10*	F32375	4,00	146	32	16	76	35,1	32	1,47
13-10*	F32385	6,70	175	42	21	89	41	38	3,15
16-10*	F32395	10,00	205	54	23	102	48	35	5,41
22-10*	F32413	15,00	265	65	29,5	127	70	65	11,40

*In development.

Shortening Components

The Clevis Shortening Hook TWN 1827

complies with DIN 5692. It makes the lifting of loads safer due to a system check which means that the shortening hook fulfills the test requirements assembled into the chain. The new shape of the shortening hooks TWN 1827 offer you much more safety than with conventional shortening hooks. The extra wide chain attachment guarantees a special firm seating of the inserted chain link and it is also protected from damage at the same time.

With our new TWN 1827 shortening hook, we are offering you grade 100 perfection continued with a long service-life of your slinging equipment.

100% magnetic crack-tested.

DGUV-approved.

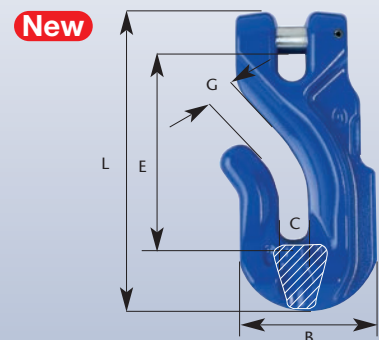

Trade Size	Article-No.	Working Load Limit [t max.]	Dimensions [mm]					Weight app. [kgs]
			E	D	L	B	C	
6-10*	F33194	1,40	-	-	-	-	-	-
8-10	F33204	2,50	71	9,5	110	55	34	0,51
10-10*	F33214	4,00	83	12,5	132	69	42	0,95
13-10*	F33224	6,70	109	15,5	168	79	54	1,76
16-10*	F33234	10,00	-	-	-	-	-	-

*In development.



Shortening Components

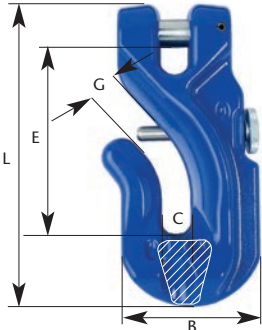

New The **Clevis Shortening Hook with Safety Pin TWN 1827/1** complies with DIN 5692 makes the lifting of loads safer due to a system inspection which means that the shortening hook fulfills the test requirements assembled into the chain. The new shape of the shortening hooks TWN 1827 offers you much more safety than with conventional shortening hooks. The extra wide chain attachment enables us to guarantee you an especially firm seating of the inserted chain link and it is also protected from damage at the same time. The locking pin prevents an accidental loosening of the sling chain. The special shape makes the THIELE-original unique.

With our new TWN 1827/1 shortening hook, we are offering you Grade 100 perfection combined with a long service-life of your slinging equipment.

100% magnetic crack-tested.

DGUV-approved.

Trade Size	Article-No.	Working Load Limit [t max.]	Dimensions [mm]					Weight app. [kgs]
			E	G	L	B	C	
6-10*	F33195	1,40	-	-	-	-	-	-
8-10	F33205	2,50	71	9,5	110	55	34	0,51
10-10	F33215	4,00	83	12,5	132	67	42	0,95
13-10	F33225	6,70	109	15,5	168	79	54	1,76
16-10*	F33235	10,00	-	-	-	-	-	-

*In development.

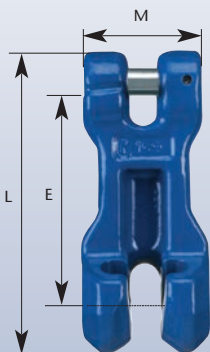

The **Clevis Shortening Claw TWN 1851**

proven over many decades from the grade 80-program, has been further developed into the grade 100. The clevis is designed to the corresponding trade size. The chain has a safe seat in the claw pocket in order to avoid release at any time.

100% magnetic crack-tested.

Trade Size	Article-No.	Working Load Limit [t max.]	Dimensions [mm]			Weight app. [kgs]
			E	L	M	
6-10	F34904	1,40	54	81	32	0,21
8-10	F34924	2,50	80	115	46	0,61
10-10	F34934	4,00	90	134	56	0,96
13-10	F34944	6,70	117	175	72	2,00
16-10	F34954	10,00	144	214	86	3,57



Shortening Components

The **RAPID-Shortening Claw TWN 1852**

can be assembled and disassembled fast and easily with no additional tools. The ergonomic and compact design enables its positioning at any place on the chain. Two robust locking devices avoid the unsafe release of the chain in a loaded or unloaded condition. The locking device is equipped with a robust spring system.

100% magnetic crack-tested.

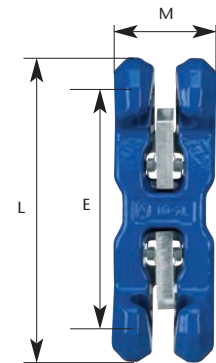

Trade Size	Article-No.	Working Load Limit [t max.]	Dimensions [mm]			Weight app. [kgs]
			E	L	M	
8-10	F34775	2,5	111	148	48	0,79
10-10	F34780	4,0	134	180	60	1,97
13-10	F34785	6,7	179	240	78	2,70
16-10	F34790	10,0	222	296	96	9,00



Shortening Components

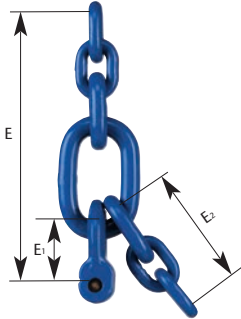

The **Fixed Size Shortening Device TWN 1896**

is the only one in the world that completes the grade 100 assembly system and is automatically attached to the trade size by a ringshackle. Therefore, it avoids the possibility of malfunction and provides additional safety for the user.

Trade Size	Article-No.	Working Load Limit [t max.]	Dimensions [mm]						Weight app. [kgs]
			E	E ₁	E ₂	B-Link			
6-10	F189606	1,4	137	31	60	10	46	23	0,32
8-10	F189608	2,5	175	38	78	13	60	30	0,70
10-10	F189610	4,0	215	46	99	16	70	35	1,40
13-10	F189613	6,7	270	59	126	18	85	40	2,60
16-10	F189616	10,0	326	76	150	22	100	50	5,00

Shackles

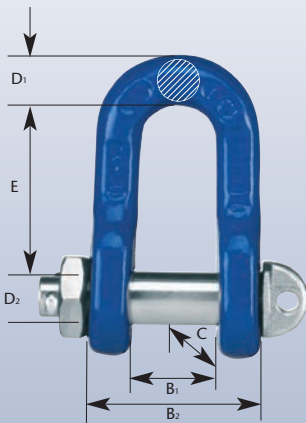

The **Bolt Shackle Type C TWN 1871**

is dimensionally in accordance with DIN 82101. It is supplied with galvanized bolt, nut and cotter pin.

100% magnetic crack-tested.

DGUV-approved.

Trade Size	Article-No.	Working Load Limit [t max.]	Dimensions [mm]						Weight app. [kgs]
			E	D ₁	D ₂	C	B ₁	B ₂	
10-10	F303100	4,0	49	15	16	32	21	47	0,45
13-10	F303200	6,7	61	19	20	40	27	61	0,84
16-10	F303300	10,0	73	23	24	48	33	75	1,41
New 22-10	F303500	19,0	111	33	36	72	47	107	4,59



Chain Tensioners

The Chain Tensioner with Spindle TWN 1454

is designed in accordance to standard EN 12195-3 and EN 1677-1. In combination with other lashing and connecting components, it is mainly used in lashing chains for the securing of loads in all industry sectors. Additionally, it is suitable for overhead lifting purposes.

The tensioners achieve a high pre-tension force with less effort because of the screw transmission. This feature is important for tying down, because only the pretension force contributes to the securing of loads.

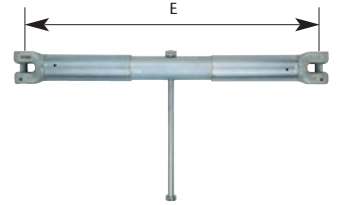

Additional features:

- + A practical dimensioned tensioning hub
- + Protected screw spindle located inside
- + Robust protection tubes
- + Integrated turn-off locking mechanism
- + Clevis type connection on both ends allows easy assembly of the corresponding round steel link chain.
- + The length of the handle is dimensioned according to EN 12195-3 (ergonomic aspect: Maximum hand pulling force is limited to 500N)
- + Finish: electro galvanized and yellow chromated

Trade Size	Article-No.	Norm. straight load (S _{TF}) [daN min.]	Tensioner under straight load [daN max.]	Dimensions [mm]			Weight app. [kgs]
				E _{max}	E _{min}	Hub	
13-10	F341877	2.600	13.000	675	445	230	7,20
16-10	F341977	3.100	20.000	834	554	280	11,80

Note: Also suitable for lifting!





Chain Tensioners

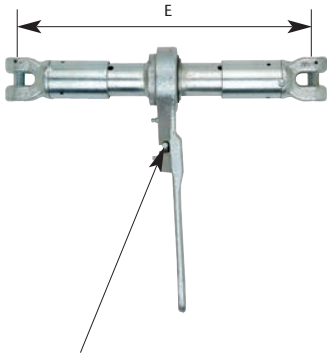

Note: The life time of the chain tensioner with ratchet may be considerably extended by regular lubrication at the greasing nipple.

The **Chain Tensioner with Ratchet TWN 1455**

is designed in accordance with standard EN 12195-3 and EN 1677-1. Together with other lashing and connecting components, they are mainly used in lashing chains for the securing of loads in all industry sectors. Additionally, they are suitable for overhead lifting purposes.

The ratchet tensioners achieve a high pre-tension force with less effort because of the screw transmission. This feature is important for tying down because only the pretension force contributes to the securing of loads.

Additional features:

- + A practical dimensioned tensioning hub
- + Protected screw spindle located inside
- + Robust protection tubes
- + Integrated turn-off locking mechanism
- + Clevis type connection on both ends allows easy assembly of the corresponding round steel link chain.
- + The length of the handle is dimensioned according to EN 12195-3 (ergonomic aspect: Maximum hand pulling force is limited to 500N)
- + Finish: electro galvanized and yellow chromated

Trade Size	Article-No.	Norm. straight load (S _{TF}) [daN min.]	Tensioner under straight load [daN max.]	Dimensions [mm]			Weight app. [kgs]
				E _{max}	E _{min}	Hub	
13-10	F341878	2.600	13.000	675	445	230	8,40
16-10	F341978	3.100	20.000	834	554	280	13,50

Note: Also suitable for lifting!





Special Sling Components

The **Skip Suspension Link for one-hand use TWN 1869** is a further development of the Grade 80 Skip Suspension Link TWN 0869. The locking device is located in a way that the suspension link can be assembled and disassembled one-handed easily at the container cones.

New

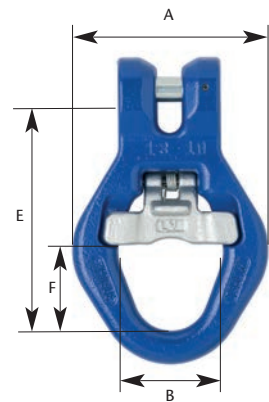

Trade Size	Article-No.	Working Load Limit [t max.]	Dimensions [mm]				Weight app. [kgs]
			E	F	B	A	
13-10	F313805	6,70	142	57,5	65	122	1,92





Special Sling Components

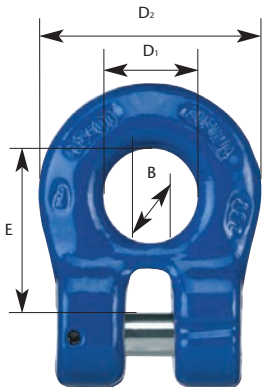

The forged **Ringshackle TWN 1812**

is automatically attached to the corresponding trade size. It can be used as a lower terminal in the chain sling and be connected to a clevis lashing point. A coupling with a **XL-LOK®** is possible.

100% magnetic crack-tested.

DGUV-approved.

Trade Size	Article-No.	Working Load Limit [t max.]	Dimensions [mm]				Weight app. [kgs]
			E	D ₁	D ₂	B	
6-10	F31704	1,40	31	17	39	8	0,10
8-10	F31714	2,50	37	21	50	11	0,20
10-10	F31724	4,00	46	26	62	14	0,39
13-10	F31734	6,70	59	33	79	18	0,83
16-10	F31744	10,00	75	42	100	23	1,59

Lashing Chains



The **Lashing Chain with Spindle Tensioner TWN 1410**

with standard length L = 3.500 mm with extended tensioner and unshortened chain complies with DIN EN 12195-3.

The length adjustment is achieved by the shortening device and the tensioner. All lengths are available upon request.

Trade Size	Article-No.	Lashing Capacity (LC) under straight load [kN max.]	Weight app. [kgs]
13-10	F34183	130	21,63
16-10	F34184	200	39,35



Lashing Chains

The Lashing Chain with Ratchet TWN 1411

with standard length L = 3.500 mm with extended tensioner and unshortened chain complies with DIN EN 12195-3.

The length adjustment is achieved by the shortening device and the tensioner. All lengths are available upon request.



Trade Size	Article-No.	Lashing Capacity (LC) under straight load [kN max.]	Weight app. [kgs]
13-10	F34183R	130	23,00
16-10	F34184R	200	41,00

Spare Parts and Accessories

All Spare Parts are only available as sets!

Chain Card File TWN 0944

Form to file the regular inspections according to EN-regulations.

Article-No. Z04575



Assembly Set TWN 0945

Consisting of 6 punches in a plastic holder to disassemble chains from components.

The complete set covers all trade sizes for the use with the THIELE-Sling-Assembly-System.

Article-No. Z03303

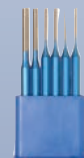

Tensioning Tag TWN 1402

Tag for lashing chains acc. to EN 12195-3.

Article-No. Z07264





Spare Parts and Accessories

Spare Parts TWN 1904/0

for Clevis Type Hooks (Bolt and Spiral Pin)

Trade Size	Article-No.	Packing Units	Weight app. [kgs]	
6-10	F48686	1 set	0,01	 <p>Load Pin for Clevis Type Hooks</p>  <p>(TWN 1835/1, TWN 1840/1, TWN 1827/1, TWN 1851)</p>
8-10	F48687	1 set	0,01	
10-10	F48688	1 set	0,03	
13-10	F48689	1 set	0,07	
16-10	F48690	1 set	0,11	

Spare Parts TWN 1908/0

for Sling Hooks (Safety Latch, Spring and Spiral Pin)

Trade Size	Article-No.	Packing Units	Weight app. [kgs]	
6-10	F48731	1 set	0,03	 <p>Spare Part Set for Sling Hooks</p>    <p>(TWN 1835/1, TWN 1840/1, TWN 1841/1)</p>
8-10	F48733	1 set	0,06	
10-10	F48735	1 set	0,11	
13-10	F48737	1 set	0,19	
16-10	F48739	1 set	0,32	
22-10	F48745	1 set	0,88	

Spare Parts and Accessories

Spare Parts TWN 1921



for **XL-LOK**[®] (Bolt and Spiral Pin)

Trade Size	Article-No.	Packing Units	Weight app. [kgs]	
6-10	F486013	1 set	0,01	 <p>Spare Part Set for XL-LOK[®] (Bolt and Spiral Pin)</p>  <p>(TWN 1820)</p>
8-10	F486043	1 set	0,01	
10-10	F486073	1 set	0,03	
13-10	F486103	1 set	0,05	
16-10	F486133	1 set	0,12	
22-10	F486191	1 set	0,46	



Spare Parts TWN 1930/0

for C-Shackle TWN 1871 (Bolt, Nut and Cotter Pin)



Trade Size	Article-No.	Packing Units	Weight app. [kgs]	
10-10	F304510	1 set	0,13	 <p>Spare Part Set for C-Shackles</p>  <p>(TWN 1871)</p>
13-10	F304610	1 set	0,25	
16-10	F304710	1 set	0,36	



Spare Parts and Accessories

Spare Parts TWN 1931/0

for RAPID® Shortening Claw TWN 1852 (2 Retainers, 2 Springs and 2 Spiral Pins)

Trade Size	Article-No.	Packing Units	Weight app. [kgs]	
8-10	F48687	1 set	0,01	 <p>Trigger Set for RAPID® Shortening Claw</p>  <p>(TWN 1852)</p>
10-10	F48688	1 set	0,03	
13-10	F48689	1 set	0,07	
16-10	F48690	1 set	0,11	

Spare Parts TWN 1933/0

for Clevis Self-Locking Hook TWN 1837 (Load Pin, 2 Spiral Pins)

Trade Size	Article-No.	Packing Units	Weight app. [kgs]	
6-10	Z10118	1 set	0,01	 <p>Spare Parts for Shortening Hook</p>  <p>(TWN 1837)</p>
8-10	Z10119	1 set	0,02	
10-10	Z10120	1 set	0,04	
13-10	Z10121	1 set	0,08	
16-10	Z10122	1 set	0,16	
22-10	Z10125	1 set	0,46	

Trigger Set TWN 1935

for Self-Locking Hooks TWN 1836 and TWN 1837 (Retainer, Spring, Assembly Plastic Bush and Spiral Pin)

Trade Size	Article-No.	Packing Units	Weight app. [kgs]	
6-10	Z10110	1 set	0,02	 <p>Trigger Set for Self-Locking Hooks</p>   <p>(TWN 1836, TWN 1837)</p>
8-10	Z10111	1 set	0,04	
10-10	Z10112	1 set	0,05	
13-10	Z10113	1 set	0,18	
16-10	Z10114	1 set	0,19	
22-10	Z10117	1 set	0,25	

Spare Parts and Accessories

Spare Parts TWN 1950

for Shortening Hook TWN 1827/1 (Safety Bolt, Pressure Spring, Knurled Screw)

Trade Size	Article-No.	Packing Units	Weight app. [kgs]	
6-10	F483310	1 set	0,01	 <p>Spare Parts for Shortening Hook</p>  <p>(TWN 1827/1)</p>
8-10	F48330	1 set	0,01	
10-10	F48328	1 set	0,02	
13-10	F483290	1 set	0,03	
16-10	F48339	1 set	0,05	



Spare Parts TWN 1951

for Combi Quick Fastener TWN 1853 (2 Bolts and 2 Spiral Pins)

Trade Size	Article-No.	Packing Units	Weight app. [kgs]	
6-10	F486865	1 set	0,02	 <p>Spare Parts for Combi-Quick Fastener</p>  <p>(TWN 1853)</p>
8-10	F486875	1 set	0,04	
10-10	F486885	1 set	0,08	
13-10	F486895	1 set	0,17	
16-10	F486905	1 set	0,29	
22-10	F486935	1 set	0,71	

Identification Tag TWN 1940

for Chain Slings

Article.-No.	Type	Weight app. [kgs]	
F08052	without welded ring	0,10	 <p>(TWN 1940)</p>
F08053	with welded ring	0,10	



Spare Parts and Accessories

Chain Gauge TWN 1946

for Round Steel Link Chains

Article-No.	Trade Size	Weight app. [kgs]	
F01690	6-10	0,10	 <p>(TWN 1946)</p>
F01691	8-10	0,15	
F01692	10-10	0,20	
F01693	13-10	0,25	
F01694	16-10	0,30	

Spare Parts TWN 0968

for Skip Suspension Link TWN 1869 (Bolt and Spiral Pin)

Trade Size	Article-No.	Packing Units	Weight app. [kgs]	
13-10	F486741	1 set	0,09	 <p>Load Pin for Skip Suspension Link</p>  <p>(TWN 1869)</p>

Spare Parts TWN 0969

for Skip Suspension Link TWN 1869 (Safety Latch, Spring and 2 Spiral Pins)

Trade Size	Article-No.	Packing Units	Weight app. [kgs]	
13-10	F314081	1 set	0,20	 <p>Spare Set for Skip Suspension Link</p>  <p>(TWN 1869)</p>



Examples for Chain Slings

1-Leg Chain Slings with **XL-LOK**®-Coupling

TWN 1600



TWN 1601



TWN 1602



TWN 1603



TWN 1604





Examples for Chain Slings

2-Leg Chain Slings with **XL-LOK**®-Coupling

TWN 1650



TWN 1651



TWN 1652



TWN 1653

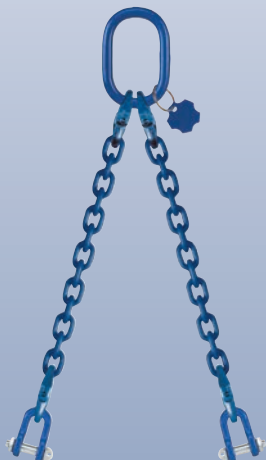

TWN 1654





Examples for Chain Slings

4-Leg Chain Slings with **XL-LOK**[®]-Coupling

TWN 1750



TWN 1751



TWN 1752



TWN 1753



TWN 1754





Examples for Chain Slings

1-Leg Chain Slings, Fixed Size

TWN 1631



TWN 1632

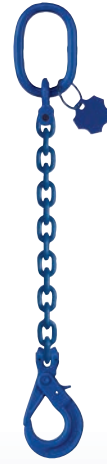

2-Leg Chain Slings, Fixed Size

TWN 1681



TWN 1682





Examples for Chain Slings

4-Leg Chain Slings, Fixed Size

TWN 1781



TWN 1782





Shortening Options





Endless Chains

Form K11

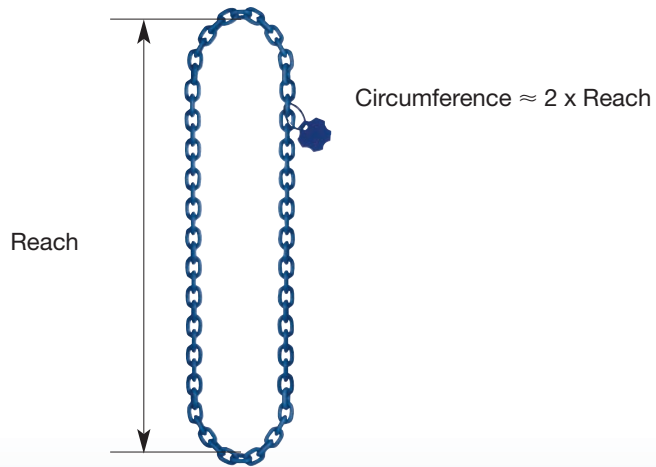

Form K12



Form K22





Operation Manual

WARNING!

- Chain Slings and Components can only be used, if user instructions and operating instructions have been read carefully and are completely understood.
- The indicated values of loads on the I.D. tags must not be exceeded.
- Due to improper use, chains can fail.

IT'S A QUESTION OF YOUR SAFETY
Death or injury can occur from improper use or maintenance!

1. Transport and Storing

All products must be protected during transportation, use, and storage in severe weather conditions.

2. Before first use

Assembling, disassembling and using should only be accomplished by authorized persons according to DGVU-R 100-500, Chapter 2.8 (in Germany) Check the following points before using the chain sling for the first time:

- all test certificates exist (declaration of conformity, inspection certificate 3.1.B etc.); the chain sling you are going to use is the same that you ordered
- Chain slings and Lashing Chains are provided with the CE label
- identification and working load limit marked on the chain sling are identical to the corresponding information indicated on the test certificate; all details concerning the chain sling have been entered into the chain card file
- The assembly is prohibited until it has been found out that the machine in which should be built in, corresponds with the EC Directive for machines and its amendments (European rules and regulations).
- In suitable intervals, check the chain sling for damages or wear (depending upon severity of conditions slings shall be inspected for damage as frequently as prior to each lift. All supplied user instructions must be maintained and available for reference until the product is removed from service.

3. Warning and use advice

- EC Directive for Machines and its amendments as per 2006/42/EG
- Operation and use instructions for chain slings according to DIN 685 - Part 5, EN 818-6.
- Consult safety regulations for round Steel Link Chains used as slinging gear in hot dipped galvanizing plants (German rules and regulations) according to DGVU-R 109-004
- Consult Safety Regulations for Cranes according to DGVU52
- Consult load Suspension Devices for Lifting Operations (German rules and safety regulations) according to DGVU-R 100-500, Chapter 2.8
- Consult Safety certificate for riggers according to BGI 556
- Consult components for chain slings according to EN 1677-2
- Consult principles for test of industrial safety of lifting products
- Consult slinging of rod iron using steel round Steel Link Chains when loading and unloading sea-going ships
- Consult German rules and regulations VDI 2700-2701-2702

Special Sling Components, hooks and clutching devices should only be used in straight tensile direction

Especially forbidden is:

- the combination of different grades when assembling (except tongs)
- the using of chain slings which do not correspond to grade 100
- overloading
- To use a combination of products with different working load limits, unless the working load noted on the I.D. tag is based on the weakest component.
- the use of twisted or knotted chains
- to use bolts or wires to connect components
- to use deformed components, rigid or elongated chains
- to lift or pull loads with sharp edges without padding the edges
- to drive equipment over chain sling
- to multiple-wrap a chain around a loadhook or tension point
- to modify products by welding, burning, bending or other mechanical modifications
- to make inadmissible modifications, e.g. the use of a 2-leg chain sling with shortening hooks as a 4-leg chain sling
- to tip load a hook into a chain link
- to apply the load on the tip, side or back of the hook
- to load connectors (XL-LOK®) at one side
- to adjust chain links or products
- to adapt inclination over 60°
- to turn swivels or swivel hooks under load
- to weld transport ring screw type lifting eyes
- to exceed the indicated grip on lifting tongs
- the use of open or riveted repair links
- Galvanizing or hot dip-galvanized

It must be taken into consideration:

- the load to be lifted
- the free mobility of the hook's safety latches
- the use under chemical influences for example acids and steam is restricted or prohibited
- the influence of temperature on alloy chain and components
- shock load impacts the chain or fitting while lifting or securing
- any type of surface treatment to chain or fittings especially Galvanizing or hot dipped galvanizing can only be carried out by the manufacturer
- when lifting keep hands and other parts of body far away from the components
- be careful when locking hooks under load Danger of injury!
- when not in use chain slings shall be hung on a rack
- ensure free mobility of chain slings or other devices in the crane hook
- when using hooks without latches pay special attention to the position of the hook placement
- to the installation position
- if necessary protect screw tensioners by locking elements to prevent automatic unlocking
- load claws with chains only on the bottom of the pocket claws
- protect chain by padding or wrapping sharp edges
- Safety latches should not be obstructed when hooks are loaded
- in case of shortening hooks, load chains must be loaded in the bowl of the hook
- hook-openings must point away from the load being lifted
- that the hook-up point and lifting hooks are compatible
- also be sure that the lifting components are suitable

for the application

- do not sit loads on the chain sling
- reduction of working load limits is necessary when making lifts at severe angles
- consult charts when using alloy chain at extreme temperatures
- working load limits must be reduced when using endless and basket slings
- extreme caution should be used when using hooks for lifting molten metal or chemicals
- chain slings shall be loaded properly to avoid damage to chain and load
- keep personnel away from loads being lifted

4. Maintenance and tests

- The chain sling must be visually inspected before use. If damage is found, you must consult a chain expert according to DGVU-R 100-500.
 - The product must be removed from service if the following damage is found:
 - unreadable tags
 - breaks or deformation
 - cuts, notches, grooves or cracks
 - strong corrosion
 - heating over the admissible temperature allowed
 - elongation of chain must not exceed 5% of manufacturer's published size
 - elongation of the overall chain length shall not exceed 5%
 - to determine wear rejection on the diameter of a link, you must measure the horizontal and the vertical and reject if reduction is more than 10%.
 - reject hooks if throat opening is opened greater than 10% of new hook or the safety latch does not seat properly
 - wear of hook eye or hook body exceed 5%
 - missing or damaged safety latch of the hook or shortening component
 - incorrect screw replacement on lifting eyes
 - incorrect or damaged bolts or turn off locking
- Do not repair chain slings yourself unless fully trained. Please contact the manufacturer or a repair expert. Use only original spare parts from THIELE.

5. Regular inspections

Regular inspection shall include measurement and visual inspection and should be carried out once each year at minimum. Each third year inspection must include crack detection (magna flux). On a new chain, you must set up a chain card index that shall contain a description of the chain as well as the identity of the certificate. The inspection schedule must be fixed. The condition of chain slings or lashing chains and their components shall be noted at each inspection. If damage is repaired, all repairs and details must be noted on the chain card.



All operation manuals are available in the THIELE download-center on our website www.THIELE.de



THIELE Lifting Products

Grade 80



Product Overview **THIELE** Lifting Products Grade 80

TWN 0805



Page
70

Round Steel Link Chains

TWN 0795



TWN 0797



TWN 0803



TWN 0810/1



TWN 0810/2



TWN 0810/4



TWN 0811/1



TWN 0811/2



TWN 0811/4



TWN 0815



TWN 0816



TWN 0817



TWN 0820



TWN 1313



TWN 1314



TWN 1315



Page
71-78

Suspension Components















TWN 1320



Page
78

THI-LOK® Connector



TWN 0798	TWN 0799	TWN 1340/1	TWN 0854	TWN 0855
				
TWN 0855/1	TWN 0856	TWN 0858/1	TWN 0859	TWN 0860
				
TWN 0868	TWN 0872	TWN 0873	TWN 0887	TWN 0889
				

Page 79-84

Hooks



TWN 0827	TWN 0827/1	TWN 0851	TWN 0896	
				

Page 85-86



Shortening Components



TWN 0861	TWN 0862	TWN 0870	TWN 0871	TWN 0897
				
TWN 0898	TWN 0898/1			
				

Page 87-88

Shackles

TWN 1450	TWN 1451	TWN 1452		
				

Page 89



Chain Tensioners

TWN 0812	TWN 0845	TWN 0869	TWN 0869/1	TWN 0875
				
TWN 0882	TWN 0892	TWN 0893	TWN 0894	TWN 0895
				

Page 90-94

Special Components and Chains



<p>TWN 1400</p> 	<p>TWN 1401</p> 
<p>TWN 0601</p> 	

Page 95-96

Special Components and Chains





<p>TWN 0904/0</p> 	<p>TWN 0905/0906</p> 	<p>TWN 0920-0922</p> 	<p>TWN 1920</p> 	<p>TWN 1920</p> 
<p>TWN 0930-0932</p> 	<p>TWN 0950-0952</p> 	<p>TWN 0962</p> 	<p>TWN 0967/0</p> 	<p>TWN 0967/1</p> 
<p>TWN 0968</p> 	<p>TWN 0969</p> 	<p>TWN 1908/5</p> 	<p>TWN 0940</p> 	<p>TWN 0941</p> 
<p>TWN 0944</p> 	<p>TWN 0945</p> 	<p>TWN 0946</p> 	<p>TWN 1402</p> 	



Page 97-103

Spare Parts and Accessories



Page 105	Form K11	Form K12	Form K22	
				
Endless Chains				

Page 107	TWN 0449	TWN 0536	TWN 0710/1	
				
Lashing Chains				

Page 110	TWN 0797	TWN 0803	TWN 0805	TWN 0871	
					
Offshore Chain Slings					



Selection Criteria for Chain Slings

1. Determine the **weight of the load** to be lifted.
2. Check **number of chain-legs** required (depending on the numbers of existing lifting points).
3. Determine the **trade size** by taking the **inclination angle** into consideration
(see table 1 on page 67, table 2 on page 68 and table 3 on page 69).
4. Consider possible (extreme) **temperature influences** (see table 4 on page 70).
5. Consider that **asymmetry** may influence the load factor (see table 5 on page 70).
6. Choose the **master links, shortening elements** and **components** suitable for the selected chain trade size.
7. Determine the **chain length** by considering the total effective reach.
8. Control (inspect) selected components and/or in-use chain slings to ensure that they meet or exceed all available industry and government safety-laws and regulations (acc. to DGUV).



Special Advices:

Please also consider more complicated conditions of use, such as intermittent impacts or loads when selecting the slings and/or components. Grade 80 chain slings and components are not allowed to be used over 400°C temperature. If the slings were used above a temperature of 400°C, then they have to be immediately be rejected. Please contact the manufacturer. The THIELE assembly system must not be used in the case of chemical influences such as acids and/or lyes.

THIELE Plant Standard (TWN)

THIELE plant standard fulfills the requirements of the EG-directive for machines, particularly for the safety relevant components. The working load limit and the test requirements meet or exceed the European standards.



Identification Tag

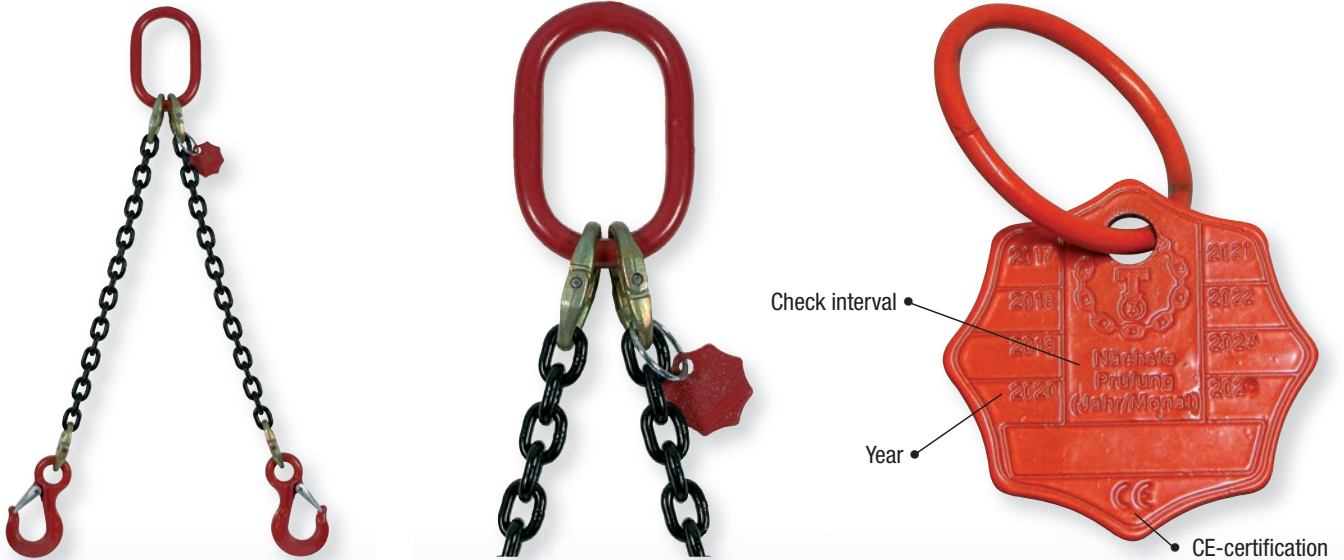

The identification tag according to DIN EN 818-4 for chain slings Grade 80 has an octagonal shape for easy identification.

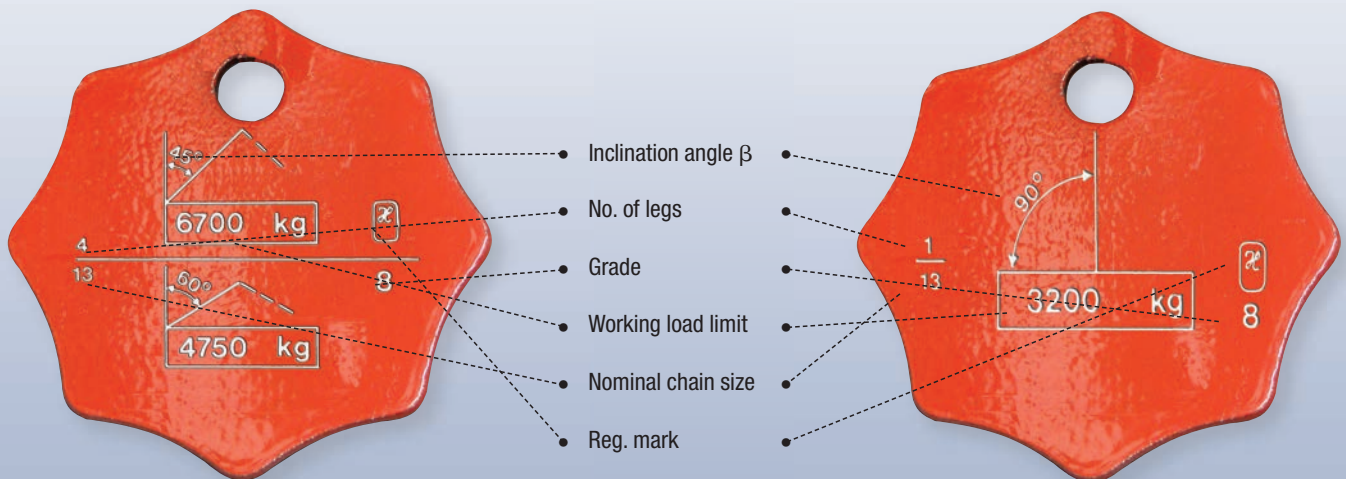



Legal Marking of Grade 80 Chains by the German DGUV

The number 4 under the \mathcal{H} represents a registration number of the German statutory accident insurance (DGUV) and helps to identify/locate the manufacturer in case of damage. The marking is also recognized from all international certification societies as well as from work authorities etc., among others the A. I. B. in Brussels.

Working Load Limit Tables

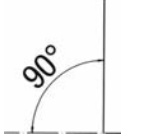
Working Load Limit – Type: Direct Slings

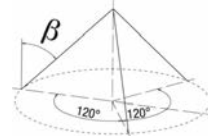
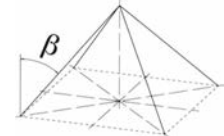
		1-leg	2-leg		3- and 4-leg	
						
Inclination Angle		$\beta = 0^\circ$	$0^\circ < \beta \leq 45^\circ$	$45^\circ < \beta \leq 60^\circ$	$0^\circ < \beta \leq 45^\circ$	$45^\circ < \beta \leq 60^\circ$
Load Factor		1	1,4	1	2,1	1,5
Trade Size	Nominal Size [mm]	[t max.]	[t max.]	[t max.]	[t max.]	[t max.]
6-8	6	1,12	1,60	1,12	2,36	1,70
7-8	7	1,50	2,12	1,50	3,15	2,24
8-8	8	2,00	2,80	2,00	4,25	3,00
10-8	10	3,15	4,25	3,15	6,70	4,75
13-8	13	5,30	7,50	5,30	11,20	8,00
16-8	16	8,00	11,20	8,00	17,00	11,80
18-8	18	10,00	14,00	10,00	21,20	15,00
20-8	20	12,50	17,00	12,50	26,50	19,00
22-8	22	15,00	21,20	15,00	31,50	22,40
26-8	26	21,20	30,00	21,20	45,00	31,50
28-8*	28	25,00	33,50	25,00	50,00	37,50
32-8	32	31,50	45,00	31,50	67,00	47,50
36-8*	36	40,00	56,00	40,00	85,00	60,00
40-8*	40	50,00	71,00	50,00	106,00	75,00
45-8*	45	63,00	90,00	63,00	132,00	95,00
50-8*	50	80,00	112,00	80,00	160,00	118,00
56-8*	56	100,00	140,00	100,00	200,00	150,00
63-8*	63	125,00	170,00	125,00	265,00	190,00
71-8*	71	160,00	224,00	160,00	335,00	236,00



Note: THIELE chain slings are available in mounted and welded execution.

*These chain slings are only available in welded execution.

Table 1

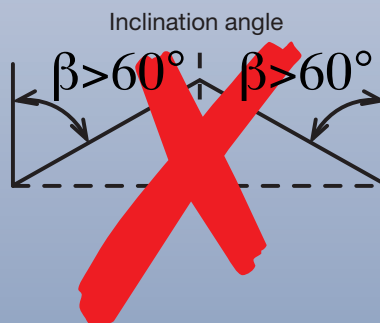

Safety Notice:

Can fail if damaged, misused or overloaded. Inspect before use. Use only if trained. Observe rated capacity in tables 1, 2, 3. DEATH or INJURY can occur from improper use or maintenance.



Working Load Limit Tables

Working Load Limit – Type: Choke Hitch

		1-leg	2-leg		endless chain looped
Inclination Angle		$\beta = 0^\circ$	$0^\circ < \beta \leq 45^\circ$	$45^\circ < \beta \leq 60^\circ$	
Load Factor		0,8	1,12	0,8	1,6
Trade Size	Normal-Size [mm]	[t max.]	[t max.]	[t max.]	[t max.]
6-8	6	0,90	1,25	0,90	1,80
7-8	7	1,25	1,70	1,25	2,50
8-8	8	1,60	2,24	1,60	3,15
10-8	10	2,50	3,55	2,50	5,00
13-8	13	4,25	6,00	4,25	8,50
16-8	16	6,30	9,00	6,30	12,50
18-8	18	8,00	11,20	8,00	16,00
20-8	20	10,00	14,00	10,00	20,00
22-8	22	11,80	17,00	11,80	23,60
26-8	26	17,00	23,60	17,00	33,50
28-8*	28	20,00	28,00	20,00	40,00
32-8	32	25,00	35,50	25,00	50,00
36-8*	36	31,50	45,00	31,50	63,00
40-8*	40	40,00	56,00	40,00	80,00
45-8*	45	50,00	71,00	50,00	100,00
50-8*	50	63,00	90,00	63,00	125,00
56-8*	56	80,00	112,00	80,00	160,00
63-8*	63	100,00	140,00	100,00	200,00
71-8*	71	125,00	180,00	125,00	250,00

Note: THIELE chain slings are available in mounted and welded execution.

*These chain slings are only available in welded execution.

Table 2

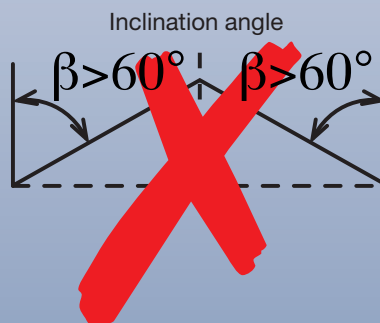

Working Load Limit Tables

Working Load Limit – Type: Endless Chain

		K11		K12	K13	K22	K23
							
Inclination Angle		$\beta = 0^\circ$	$0^\circ < \beta \leq 25^\circ$	$0^\circ < \beta \leq 45^\circ$	$45^\circ < \beta \leq 60^\circ$	$0^\circ < \beta \leq 45^\circ$	$45^\circ < \beta \leq 60^\circ$
Load Factor		1,6	1,45	1,12	0,8	1,7	1,2
Trade Size	Nominal Size [mm]	[t max.]	[t max.]	[t max.]	[t max.]	[t max.]	[t max.]
6-8	6	1,80	1,60	1,25	0,90	1,90	1,32
7-8	7	2,50	2,24	1,70	1,25	2,65	1,80
8-8	8	3,15	2,80	2,24	1,60	3,35	2,36
10-8	10	5,00	4,50	3,55	2,50	5,30	3,75
13-8	13	8,50	7,50	6,00	4,25	9,00	6,30
16-8	16	12,50	11,80	9,00	6,30	13,20	9,50
18-8	18	16,00	15,00	11,20	8,00	17,00	11,80
20-8	20	20,00	18,00	14,00	10,00	21,20	15,00
22-8	22	23,60	22,40	17,00	11,80	25,00	18,00
26-8	26	33,50	30,00	23,60	17,00	35,50	25,00
28-8	28	40,00	35,50	28,00	20,00	42,50	30,00
32-8	32	50,00	47,50	35,50	25,00	53,00	37,50
36-8	36	63,00	60,00	45,00	31,50	67,00	47,50
40-8	40	80,00	71,00	56,00	40,00	85,00	60,00
45-8	45	100,00	90,00	71,00	50,00	106,00	75,00
50-8	50	125,00	112,00	90,00	63,00	132,00	95,00
56-8	56	160,00	140,00	112,00	80,00	170,00	118,00
63-8	63	200,00	180,00	140,00	100,00	212,00	150,00
71-8	71	250,00	224,00	180,00	125,00	265,00	190,00



Table 3



Type K11

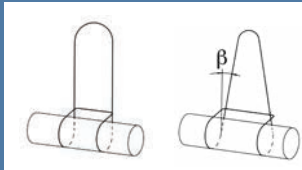
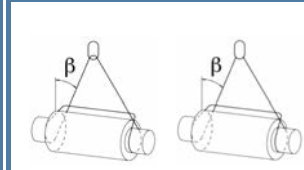
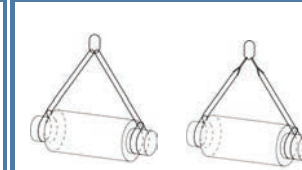

Type K12



Type K22



Load Reductions

Temperature Application Range

Temperature Application Range	Working Load Limit
-40°C to 200°C	100 %
over 200°C to 300°C	90 %
over 300°C to 380°C	75 %

If Grade 80 - alloy slings are used at temperatures exceeding 200°C, then the working load limit has to be reduced. Before using the alloy slings at temperatures below -40°C, the manufacturer has to be consulted.

Table 4

Load Factor at Asymmetry

No. of Legs	1		2		3		4	
	Inclination Angle β	Load Factor	Inclination Angle β	Load Factor	Inclination Angle β	Load Factor	Inclination Angle β	Load Factor
-	0° – 45°	1	45° – 60°	1	0° – 45°	1,4	45° – 60°	1
-	0° – 45°	1,4	45° – 60°	1	0° – 45°	1,4	45° – 60°	1

Table 5

Round Steel Link Chains TWN 0805



Trade Size	Article-No.			Nominal Size		Pitch		Inside Width	Outside Width	Working Load Limit [t max.]	Weight app. [kgs]
	self-coloured	RAL 9005	corrothiel	d [mm]	tol. \pm [mm]	p [mm]	tol. \pm [mm]	w ₁ [mm min.]	w ₂ [mm max.]		
6-8	F01452	F01453	F01454	6,00	0,24	18,00	0,5	7,80	22,20	1,12	0,8
7-8	F01458	F01459	F01457	7,20	0,20	21,80	0,6	9,45	25,20	1,50	1,1
8-8	F01464	F01465	F01429	8,00	0,32	24,00	0,7	10,40	29,60	2,00	1,4
10-8	F01469	F01470	F01450	10,00	0,40	30,00	0,9	13,00	37,00	3,15	2,2
13-8	F01474	F01475	F01476	13,00	0,52	39,00	1,2	16,90	48,10	5,30	3,8
16-8	F01479	F01480	F01487	16,00	0,64	48,00	1,4	20,80	59,20	8,00	5,7
18-8	F01484	F01485	F04580	18,00	0,90	54,00	1,6	23,40	66,60	10,00	7,3
20-8	F01494	F01495	F04606	20,00	1,00	60,00	1,8	26,00	74,00	12,50	9,0
22-8	F01499	F01500	F04629	22,00	1,10	66,00	2,0	28,60	81,40	15,00	10,9
26-8	F01514	F01515	F04695	26,00	1,30	78,00	2,3	33,80	96,20	21,20	15,2
28-8*	F01519	F01520	F01521	28,00	1,40	84,00	2,5	36,40	104,00	25,00	17,6
32-8	F01524	F01525	F01526	32,00	1,60	96,00	2,9	41,60	118,00	31,50	23,0
36-8*	F01529	F01530	F04814	36,00	1,80	108,00	3,0	46,80	133,00	40,00	29,0
40-8*	F01534	F01535	F04838	40,00	2,00	120,00	4,0	52,00	148,00	50,00	36,0
45-8*	F01539	F01540	F04889	45,00	2,30	135,00	4,0	58,50	167,00	63,00	45,5
50-8*	F01545	F01546	F04900	50,00	2,50	150,00	4,5	67,50	180,00	80,00	56,0
56-8*	F01555	F01556	F04908	56,00	2,80	170,00	5,0	75,60	201,60	100,00	72,5
63-8*	-	F01566	-	63,00	3,20	190,00	6,0	88,00	230,00	125,00	89,0
71-8*	-	F01598	-	71,00	3,60	210,00	6,0	99,00	260,00	160,00	110,0

*These sling chains are only available in welded finish.

Elongation at break, self coloured: min. 25%; bright finished: min 20%.

Factor: Working load limit : Proof force : Breaking force = 1 : 2,5 : 4 (200 : 500 : 800 N/mm²)



Suspension Components

THIELE Components of the GK8-Assembly System have a Safety Factor of 4 and comply with all present standards such as EN 818, EN 1677 and DIN 5688-3.

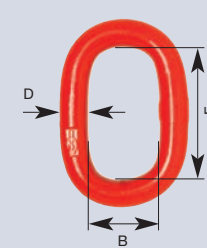
Trade Size	Article-No.	Working Load Limit [t max.]	Dimensions [mm]			Weight app. [kgs]	TWN 0795
			D	F	B		
B 8	F122880	1,12	8	36	18	0,05	 <p>Intermediate Master Link Type B according to DIN 5688-3</p>
B 10	F122890	2,00	10	46	23	0,09	
B 13	F122930	3,15	13	60	30	0,20	
B 16	F122970	5,30	16	70	35	0,36	
B 18	F123010	6,70	18	85	40	0,54	
B 20	F123030	8,00	20	90	45	0,73	
B 22	F123070	10,00	22	100	50	0,97	
B 26	F123090	12,50	26	120	60	1,60	
B 28	F123190	15,00	28	130	65	1,90	
B 32	F123110	21,20	32	140	70	2,90	
B 36	F123130	25,00	36	160	80	4,20	
B 40	F123150	31,50	40	180	90	5,80	
B 45	F123170	40,00	45	200	100	8,20	
B 50	F123210	50,00	50	220	110	11,00	
B 56	F123230	63,00	56	260	130	16,00	
B 63	F123270	80,00	63	280	140	22,00	
B 70	F123290	100,00	70	320	160	31,00	
B 80	F123300	125,00	80	360	180	46,50	
B 90	F123320	160,00	90	400	200	65,50	

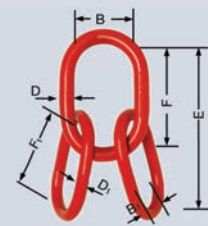

Article-No.	Working L. L. ($\beta = 0^\circ - 45^\circ$) SF= 1:4 [t max.]	Dimensions [mm]							Weight app. [kgs]	TWN 0797 (Offshore)
		E	D	F	B	D ₁	F ₁	B ₁		
F0797268	7,90	340	26	180	100	22	160	90	5,30	 <p>Offshore Master Link Assembly for 3- and 4-Leg Wire Rope</p>
F0797328	11,30	410	32	230	125	26	180	100	9,00	
F0797368	16,00	480	36	250	140	32	230	125	15,00	
F0797458	22,60	570	45	320	175	36	250	140	24,40	
F0797508	26,80	660	50	340	190	45	320	175	40,00	
F0797568	40,00	720	56	380	210	50	340	190	55,00	
F0797638	50,00	810	63	430	240	56	380	210	79,00	

Acc. to DNV 2.7-1:2013-06.

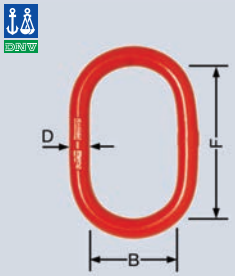

Suspension Components

Article-No.	Working Load Limit [t max.]	Dimensions [mm]			Weight app. [kgs]	TWN 0803 (Offshore)
		D	F	B		
F0803208	4,75	20	140	80	1,10	 <p>Offshore Oblong Master Link Type A</p>
F0803228	5,60	22	160	90	1,50	
F0803268	8,00	26	180	100	2,30	
F0803328	12,50	32	230	125	4,40	
F0803368	16,00	36	250	140	6,20	
F0803408	19,00	40	290	160	8,80	
F0803458	25,00	45	320	175	12,00	
F0803508	31,50	50	340	190	16,00	
F0803568	40,00	56	380	210	23,00	
F0803638	50,00	63	430	240	33,00	
F0803708	63,00	70	470	260	44,00	
F0803808	80,00	80	520	290	64,00	

Acc. to DNV 2.7-1:2013-06.

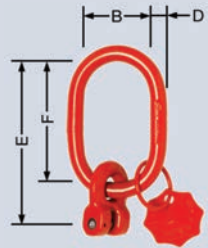

Suspension Components

Trade Size	Article-No.	Working Load Limit [t max.]	Dimensions [mm]				Weight app. [kgs]	TWN 0810/1
			E	D	F	B		
6-8	F08101068	1,12	121	13	90	50	0,40	 <p>Fixed Size Master Link Assembly Type TAA 1 for 1-Leg Sling Chains</p>
8-8	F08101088	2,00	147	16	110	60	1,00	
10-8	F08101108	3,15	176	18	130	70	1,20	
13-8	F08101138	5,30	219	22	160	90	2,30	
16-8	F08101168	8,00	255	26	180	100	4,00	
22-8	F08101228	15,00	350	36	250	140	10,0	

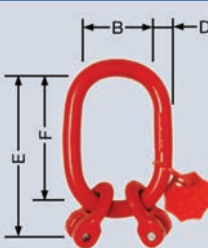

Trade Size	Article-No.	Working Load Limit ($\beta = 0^\circ - 45^\circ$) [t max.]	Dimensions [mm]				Weight app. [kgs]	TWN 0810/2
			E	D	F	B		
6-8	F08102068	1,60	121	13	90	50	0,50	 <p>Fixed Size Master Link Assembly Type TAA 2 for 2-Leg Sling Chains</p>
8-8	F08102088	2,80	167	18	130	70	1,20	
10-8	F08102108	4,25	186	20	140	80	1,90	
13-8	F08102138	7,50	239	26	180	100	4,00	
16-8	F08102168	11,20	305	32	230	125	7,60	
22-8	F08102228	21,20	420	45	320	175	19,60	

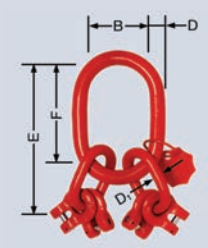
Trade Size	Article-No.	Working Load Limit ($\beta = 0^\circ - 45^\circ$) [t max.]	Dimensions [mm]					Weight app. [kgs]	TWN 0810/4
			E	D	F	B	D ₁		
6-8	F08104068	2,36	201	16	110	60	13	1,40	 <p>Fixed Size Master Link Assembly Type TAA 4 for 3- and 4-Leg Sling Chains</p>
8-8	F08104088	4,25	267	22	160	90	16	3,10	
10-8	F08104108	6,70	316	26	180	100	20	5,40	
13-8	F08104138	11,20	409	32	230	125	26	11,10	
16-8	F08104168	17,00	495	40	290	160	28	19,00	
22-8	F08104228	31,50	620	50	340	190	40	42,80	

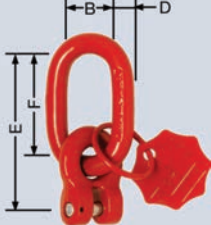

Suspension Components

Trade Size	Article-No.	Working Load Limit [t max.]	Dimensions [mm]				Weight app. [kgs]	TWN 0811/1
			E	D	F	B		
6-8	F08111068	1,12	91	13	60	30	0,31	 <p>Fixed Size Master Link Assembly Type TAB 1 for 1-Leg Sling Chains</p>
8-8	F08111088	2,00	107	16	70	35	0,57	
10-8	F08111108	3,15	136	20	90	45	1,14	
13-8	F08111138	5,30	159	22	100	50	1,84	
16-8	F08111168	8,00	195	26	120	60	3,20	
18-8	F08111188	10,00	219	32	140	70	5,40	
22-8	F08111228	15,00	260	36	160	80	8,00	

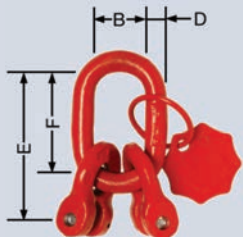
Trade Size	Article-No.	Working Load Limit ($\beta = 0^\circ - 45^\circ$) [t max.]	Dimensions [mm]				Weight app. [kgs]	TWN 0811/2
			E	D	F	B		
6-8	F08112068	1,60	91	13	60	30	0,42	 <p>Fixed Size Master Link Assembly Type TAB 2 for 2-Leg Sling Chains</p>
8-8	F08112088	2,80	107	16	70	35	0,78	
10-8	F08112108	4,25	136	20	90	45	1,60	
13-8	F08112138	7,50	179	26	120	60	3,30	
16-8	F08112168	11,20	205	28	130	65	5,10	
18-8	F08112188	14,00	219	32	140	70	7,90	
22-8	F08112228	21,20	280	40	180	90	13,00	

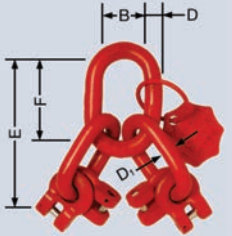
Trade Size	Article-No.	Working Load Limit ($\beta = 0^\circ - 45^\circ$) [t max.]	Dimensions [mm]					Weight app. [kgs]	TWN 0811/4
			E	D	F	B	D ₁		
6-8	F08114068	2,36	161	16	70	35	13	1,20	 <p>Fixed Size Master Link Assembly Type TAB 4 for 3- and 4-Leg Sling Chains</p>
8-8	F08114088	4,25	197	20	90	45	16	2,29	
10-8	F08114108	6,70	236	22	100	50	20	4,07	
13-8	F08114138	11,20	299	26	120	60	26	8,28	
16-8	F08114168	17,00	345	32	140	70	28	13,10	
18-8	F08114188	21,20	379	36	160	80	32	20,00	
22-8	F08114228	31,50	460	40	180	90	40	32,60	

Suspension Components

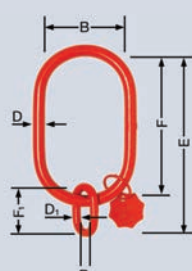
Trade Size	Article-No.	Working Load Limit [t max.]	Dimensions [mm]							Suitable for Crane Hooks acc. DIN 15401 [No.]	Weight app. [kgs]	TWN 0815
			E	D	F	B	D ₁	F ₁	B ₁			
6-8	F08150616	1,12	320	18	260	140	13	60	30	16	1,67	 <p>Diagram showing dimensions: B, D, L, W, D₁, F₁, B₁.</p>
8-8	F08150816	2,00	330	22	260	140	16	70	35	16	2,60	
10-8	F08151016	3,15	330	22	260	140	16	70	35	16	2,60	
13-8	F08151316	5,30	260	26	260	140				16	3,17	
16-8	F08151616	8,00	260	30	260	140				16	4,30	
18-8	F08151816	10,00	370	36	250	140	26	120	60	16	7,80	
6-8	F08150625	1,12	400	20	340	180	13	60	30	25	2,54	
8-8	F08150825	2,00	400	20	340	180	13	60	30	25	2,54	
10-8	F08151025	3,15	410	24	340	180	16	70	35	25	3,78	
13-8	F08151325	5,30	410	28	340	180	16	70	35	25	5,07	
16-8	F08151625	8,00	430	32	340	180	20	90	45	25	6,95	
18-8	F08151825	10,00	440	40	340	180	22	100	50	25	10,9	
20-8	F08152025	12,50	340	40	340	180				25	9,97	
22-8	F08152225	15,00	340	40	340	180				25	9,97	
6-8	F08150640	1,12	490	22	430	220	13	60	30	40	3,73	
8-8	F08150840	2,00	490	22	430	220	13	60	30	40	3,73	
10-8	F08151040	3,15	500	26	430	220	16	70	35	40	5,33	
13-8	F08151340	5,30	500	30	430	220	16	70	35	40	7,05	
16-8	F08151640	8,00	520	34	430	220	20	90	45	40	9,41	
18-8	F08151840	10,00	530	42	430	220	22	100	50	40	14,5	
20-8	F08152040	12,50	430	42	430	220				40	13,5	
22-8	F08152240	15,00	430	42	430	220				40	13,5	

Overize Master Link Assy for 1-Leg Sling Chains suitable for Crane Hooks DIN 15401 (16 t, 25 t, 40 t)

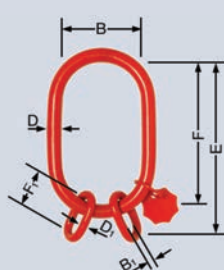
Trade Size	Article-No.	Working Load Limit ($\beta = 0^\circ - 45^\circ$) [t max.]	Dimensions [mm]							Suitable for Crane Hooks acc. DIN 15401 [No.]	Weight app. [kgs]	TWN 0816
			E	D	F	B	D ₁	F ₁	B ₁			
6-8	F08160616	1,60	320	18	260	140	13	60	30	16	1,88	 <p>Diagram showing dimensions: B, D, L, W, D₁, F₁, B₁.</p>
8-8	F08160816	2,80	330	22	260	140	16	70	35	16	2,96	
10-8	F08161016	4,25	330	26	260	140	16	70	35	16	3,90	
13-8	F08161316	7,50	350	30	260	140	20	90	45	16	5,75	
16-8	F08161616	11,20	370	36	250	140	26	120	60	16	9,43	
6-8	F08160625	1,60	400	22	340	180	13	60	30	25	3,26	
8-8	F08160825	2,80	410	24	340	180	16	70	35	25	4,14	
10-8	F08161025	4,25	410	28	340	180	16	70	35	25	5,43	
13-8	F08161325	7,50	430	32	340	180	20	90	45	25	7,68	
16-8	F08161625	11,20	440	40	340	180	22	100	50	25	11,9	
18-8	F08161825	14,00	440	40	340	180	22	100	50	25	11,9	
20-8	F08162025	17,00	480	45	340	180	32	140	70	25	18,6	
6-8	F08160640	1,60	500	26	430	220	16	70	35	40	5,70	
8-8	F08160840	2,80	500	26	430	220	16	70	35	40	5,70	
10-8	F08161040	4,25	500	30	430	220	16	70	35	40	7,42	
13-8	F08161340	7,50	500	34	430	220	20	90	45	40	9,88	
16-8	F08161640	11,20	530	42	430	220	22	100	50	40	15,5	
18-8	F08161840	14,00	530	42	430	220	22	100	50	40	15,5	
22-8	F08162240	21,20	570	48	430	220	32	140	70	40	23,7	

Overize Master Link Assy for 2-Leg Sling Chains suitable for Crane Hooks DIN 15401 (16 t, 25 t, 40 t)

Suspension Components

For Chain Slings Trade Size		Article-No.	Working Load Limit [t max.]	Dimensions [mm]			Weight app. [kgs]	TWN 1313
1-Leg	2-Leg			D	F	B		
6 (7)	6	F1313013	2,00	13	90	50	0,29	 <p>Oblong Master Link Type A</p>
8	(7)	F1313016	3,20	16	110	60	0,53	
10	8	F1313018	4,00	18	130	70	0,79	
	10	F1313020	4,80	20	140	80	1,10	
13		F1313022	5,60	22	160	90	1,50	
16	13	F1313026	8,00	26	180	100	2,30	
18/20	16	F1313032	12,50	32	230	125	4,40	
22	18	F1313036	16,00	36	250	140	6,20	
	20	F1313040	19,00	40	290	160	8,80	
26/28	22	F1313045	25,00	45	320	175	12,00	
32	26	F1313050	31,50	50	340	190	16,00	
36	28	F1313056	40,00	56	380	210	23,00	
40	32	F1313063	50,00	63	430	240	33,00	
45	36	F1313070	63,00	70	470	260	44,00	
50	40	F1313080	80,00	80	520	290	64,00	
56	45	F1313085	100,00	85	520	290	73,00	
63	50	F1313095	125,00	95	580	320	100,00	
71	56	F1313110	160,00	110	680	380	160,00	

Note: The new TWN 1313 replaces the TWN 0807 and TWN 0808.
Rated for 2-leg chain slings use with inclination angle $0^\circ < \beta \leq 45^\circ$.

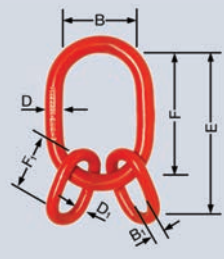
Trade Size	Article-No.	Working Load Limit ($\beta = 0^\circ - 45^\circ$) [t max.]	Dimensions [mm]							Weight app. [kgs]	TWN 1314
			E	D	F	B	D ₁	F ₁	B ₁		
6-8	F1314016	3,15	170	16	110	60	13	60	30	1,40	 <p>Master Link Assembly for 3- and 4-Leg Sling Chains</p>
8-8	F1314020	4,75	210	20	140	80	16	70	35	1,80	
10-8	F1314026	8,00	270	26	180	100	20	90	45	3,80	
13-8	F1314032	12,50	350	32	230	125	26	120	60	7,70	
16-8	F1314040	19,00	420	40	290	160	28	130	65	13,00	
18-8	F1314045	25,00	460	45	320	175	32	140	70	18,00	
20-8	F1314050	31,50	500	50	340	190	36	160	80	25,00	
22-8	F1314050A	31,50	520	50	340	190	40	180	90	28,00	
26-8	F1314063	50,00	630	63	430	240	45	200	100	49,00	
28-8	F1314063A	50,00	630	63	430	240	45	200	100	49,00	
32-8	F1314080	71,00	740	80	520	290	50	220	110	86,00	
36-8	F1314085	85,00	780	85	520	290	56	260	130	106,00	
40-8	F1314095	112,00	860	95	580	320	63	280	140	146,00	
45-8	F1314110	132,00	1000	110	680	380	70	320	160	223,00	
50-8	F1314110A	160,00	1040	110	680	380	80	360	180	252,00	

Note: The new TWN 1314 replaces the TWN 0809.



Suspension Components

New

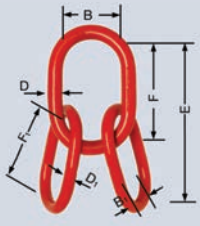
Article-No.	Working Load Limit ($\beta = 0^\circ - 45^\circ$) [t max.] SF= 1:4	Dimensions [mm]							Categorization of the wire rope diameter		Weight app. [kgs]	TWN 1315	
		E	D	F	B	D ₁	F ₁	B ₁	Fiber Rope [mm]	Steel Rope [mm]			
F1315016	2,80	200	16	110	60	13	90	50	11	10	1,10	 <p>Master Link Assembly for 3- and 4-leg Wire Rope Slings acc. to EN 13414-1</p>	
F1315018	4,00	240	18	130	70	16	110	60	13	12	1,90		
F1315022	5,30	290	22	160	90	18	130	70	14	14	3,10		
F1315026	7,50	340	26	180	100	22	160	90	18	16	5,30		
F1315032	11,10	410	32	230	125	26	180	100	22	20	9,00		
F1315036	16,00	480	36	250	140	32	230	125	26	24	15,00		
F1315045	21,00	570	45	320	175	36	250	140	28	28	24,00		
F1315050	31,60	660	50	340	190	45	320	175	36	36	40,00		
F1315056	40,20	720	56	380	210	50	340	190	40	40	55,00		
F1315063	50,10	810	63	430	240	56	380	210	44	44	79,00		
F1315085	101,80	1040	85	520	290	80	520	290	60	60	200,00		

Note: The new TWN 1315 replaces the TWN 0796.

THI-LOK® Connector

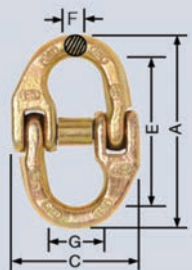
Trade Size	Article-No.	Working Load Limit [t max.]	Dimensions [mm]						Weight app. [kgs]	TWN 1320
			E	G	A	C	B	F		
6-8	F30806	1,12	46	15	62	42	11	6	0,07	 <p>THI-LOK®</p>
7/8-8	F30816	2,00	56	20	78	55	14	9	0,16	
10-8	F30826	3,15	69	25	93	68	18	12	0,30	
13-8	F30836	5,30	84	30	116	75	23	15	0,60	
16-8	F30846	8,00	102	35	146	97	26	19	1,20	
18-8	F30850	10,00	122	36	165	110	31	22	1,86	
20-8	F30855	12,50	134	45	185	122	36	26	2,33	
22-8	F30860	15,00	145	46	198	132	38	26	3,16	
26-8	F30870	21,20	164	55	225	156	44	30	5,00	
32-8	F30880	31,50	192	65	268	192	55	37	9,33	

Hooks

Trade Size	Article-No.	Working Load Limit [t max.]	Dimensions [mm]					Weight app. [kgs]	TWN 0798
			E	D	G	H	C ₁		
6-8	Z07274	1,12	106	22,5	28	22	15	0,48	 <p>Eye Self-Locking Hook</p>
7/8-8	Z07275	2,00	133	24	35	25	20	0,82	
10-8	Z07276	3,15	167	32	45	35	27	1,65	
13-8	Z07277	5,30	208	39	54	41	33	3,12	
16-8	Z07278	8,00	250	49	67	54	39	5,88	
18/20-8	F092255	12,50	257	60	74	57	43	7,33	
22-8	F092275	15,00	290	71	88	62	52	9,91	

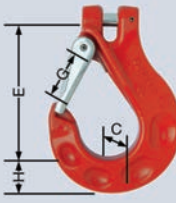

Trade Size	Article-No.	Working Load Limit [t max.]	Dimensions [mm]				Weight app. [kgs]	TWN 0799
			E	G	H	C		
6-8	Z07279	1,12	98	28	22	15	0,57	 <p>Clevis Self-Locking Hook</p>
8-8	Z07280	2,00	122	33	25	20	0,93	
10-8	Z07281	3,15	150	45	35	27	1,75	
13-8	Z07282	5,30	186	54	41	33	3,25	
16-8	Z07296	8,00	215	67	54	39	6,20	
18/20-8	F0922055	12,50	215	74	57	43	7,28	

Trade Size	Article-No.	Working Load Limit [t max.]	Dimensions [mm]				Weight app. [kgs]	TWN 1340/1
			E	G	H	C		
6-8	F336010	1,12	75	24	20	17	0,36	 <p>Clevis Sling Hook with Safety Latch</p>
8-8	F336110	2,00	92	30	25	22	0,75	
10-8	F336210	3,15	113	37	32	28	1,40	
13-8	F336310	5,30	133	42	41	35	2,50	
16-8	F336410	8,00	162	51	50	41	4,40	
18-8*	F33651	10,00	195	60	52	50	7,59	
20-8*	F33656	12,50	220	65	58	55	9,68	
22-8*	F33661	15,00	244	75	64	61	10,62	

New

Note: The new TWN 1340/1 replace the TWN 0835/1 (only trade sizes 6-8 to 16-8).
With heavy duty forged safety latch.

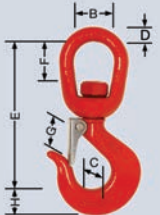

Hooks

Trade Size	Article-No.	Working Load Limit [t max.]	Dimensions [mm]							Weight app. [kgs]	TWN 0854
			E	G	H	C	F	B	D		
0,75-8M	F32103*	0,75	113,5	19	14	13	25	30	10	0,36	 <p>Swivel Hook with Safety Latch</p>
6-8	F32100	1,12	113	21	19	14	25	30	10	0,38	
8-8	F32110	2,00	155	25	24,5	19	42	44	16	1,00	
10-8	F32120	3,15	162	28	28,5	21	42	44	16	1,20	
13-8	F32130	5,30	190	34	33	28	43	51	19	2,08	
16-8	F32140	8,00	247	42	43	35	60	64	25	4,45	

*Upon request.

Note: Also available for wire ropes and thimbles; Swivel hooks are only for stripping and not built for twisting purposes under load.

Note: The hooks TWN 1340/1, TWN 0835/1 and TWN 0858/1 comply to the EN 1677-2. Both forces f_1 and f_2 must withstand min. 300 kg or 10% of working load limit of the hook, depending on which value is larger. But the forces f_2 should not be larger than 20 kN.

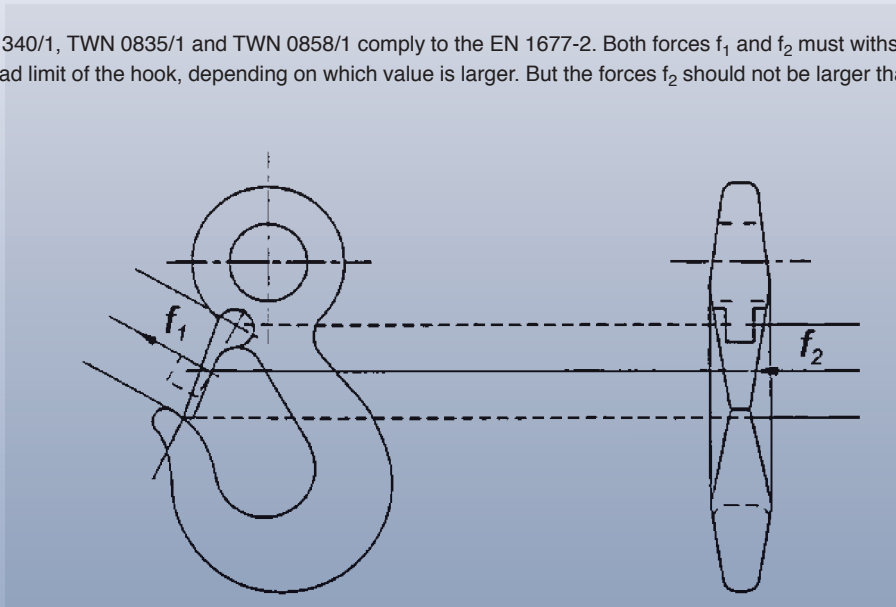

Hooks

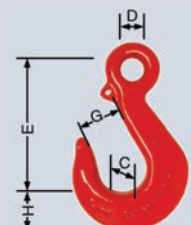
Trade Size	Article-No.	Working Load Limit [t max.]	Dimensions [mm]					Weight app. [kgs]	TWN 0855
			E	D	G	H	C		
36-8	Z04079	40,00	388	72	109	103	78	31,50	 <p>Eye Sling Hook</p>
40-8	Z04083	50,00	442	84	124	116	89	46,00	
45-8	Z04080	63,00	494	90	138	130	99	63,00	
50-8	Z04081	80,00	610	102	155	145	110	80,00	

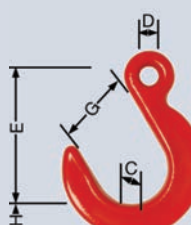

Trade Size	Article-No.	Working Load Limit [t max.]	Dimensions [mm]					Weight app. [kgs]	TWN 0855/1
			E	D	G	H	C		
36-8	Z06159	40,00	388	72	109	103	78	32,30	 <p>Eye Sling Hook with Safety Latch</p>
40-8	Z06160	50,00	442	84	124	116	89	47,00	
45-8	Z06161	63,00	494	90	138	130	99	64,40	
50-8	Z06162	80,00	610	102	155	145	110	81,90	

Trade Size	Article-No.	Working Load Limit [t max.]	Dimensions [mm]					Weight app. [kgs]	TWN 0856
			E	D	G	H	C		
6-8	Z00456	1,12	95	13	50	24	20	0,53	 <p>Eye Foundry Hook</p>
8-8	F32360	2,00	125	18	66	33	27	0,93	
10-8	F32370	3,15	146	20	76	35	32	1,66	
13-8	F32380	5,30	175	26	89	41	38	3,15	
16-8	F32390	8,00	205	32	102	48	45	5,41	
18/20-8	F32400	12,50	235	40	114	54	51	7,50	
22-8	Z00457	15,00	265	47	127	70	65	11,40	
26-8	Z00458	21,20	305	52	136	80	72	13,60	
32-8	Z00459	31,50	327	60	162	93	83	28,00	



Hooks

Trade Size	Article-No.	Working Load Limit [t max.]	Dimensions [mm]						Weight app. [kgs]	TWN 0858/1
			E	D ₁	D ₂	G	H	C		
6-8	F329010	1,12	91	21	11	24	20	17	0,36	
8-8	F329110	2,00	118	28	14	30	25	22	0,78	
10-8	F329210	3,15	145	36	18	37	32	28	1,50	
13-8	F329310	5,30	168	42	21	42	41	35	2,55	
16-8	F329410	8,00	210	54	25	51	50	41	4,65	
18/20-8	F329510	12,50	270	62	30	65	58	55	8,70	
22-8	F329710	15,00	271	65	30	70	62	54	9,77	
26-8	F329810	21,20	302	70	33	75	71	59	14,20	
32-8	F329910	31,50	350	80	38	90	86	67	23,80	



SOLIDO®
Eye Sling Hook
with Safety Latch

Note: Forged safety latch.

Trade Size	Article-No.	Working Load Limit [t max.]	Dimensions [mm]				Weight app. [kgs]	TWN 0859
			E	G	H	C		
8-8	F33310	2,00	110	66	33	27	1,00	
10-8	F33320	3,15	133	76	35	32	1,61	
13-8	F33330	5,30	159	89	41	38	3,40	
16-8	F33340	8,00	189	102	48	45	5,50	

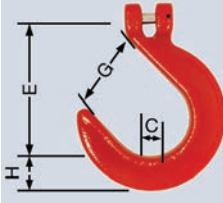

Clevis Foundry Hook

Trade Size	Article-No.	Working Load Limit [t max.]	Dimensions [mm]					Weight app. [kgs]	TWN 0860
			E	G	R	D	B		
	F18130	0,15	80	28	14	10	16	0,12	
	F18160	0,25	100	36	18	12	20	0,21	
	F18180	0,40	130	46	23	16	25	0,48	
	F18200	0,80	160	56	28	20	30	0,91	
6-8	F18220	1,12	180	64	32	22	32	1,20	
7-8	F18230	1,50	200	70	35	26	35	1,90	
8-8	F18250	2,00	230	80	40	32	40	3,40	
10-8	F18260	3,15	260	90	45	36	45	4,80	
	F18280	4,00	300	104	52	40	52	6,80	
13-8	F18290	4,50	350	122	61	45	60	10,00	
	F18300	5,30	400	140	70	51	68	14,60	
16-8	F18310	6,00	450	158	79	57	75	20,50	
	F18320	8,00	500	160	80	63	80	27,40	
18-8	F18330	10,00	550	166	83	72	85	39,00	

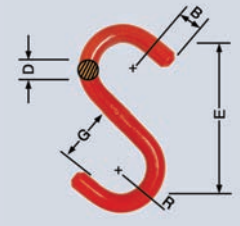

S-Hook



Hooks

Trade Size	Article-No.	Working Load Limit [t max.]	Dimensions [mm]							Weight app. [kgs]	TWN 0887
			E	G	H	C	D	F	B		
	F32160	0,35	98,5	14	14	14	9	20	16	0,24	 <p>Swivel Hook</p>

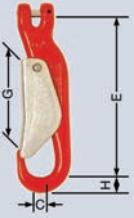
Trade Size	Article-No.	Working Load Limit [t max.]	Dimensions [mm]				Weight app. [kgs]	TWN 0889
			E	G	H	C		
6-8*	F33439	0,50	137	19	13	12	0,55	 <p>Lifting Hook for Engines</p>

*Note: For trade size 6-8, but WLL limited to max 0,5 t.

Shortening Components

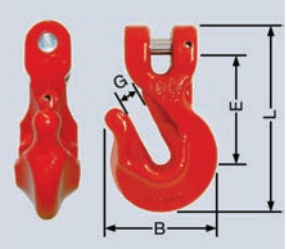
Trade Size	Article-No.	Working Load Limit [t max.]	Dimensions [mm]				Weight app. [kgs]	TWN 0827
			E	G	L	B		
8-8	F33200	2,00	61	9	101	61	0,53	
10-8	F33210	3,15	73	12	125	75	0,97	
13-8	F33220	5,30	95	15	160	95	2,18	
16-8	F33230	8,00	112	18	188	120	3,40	
20-8	F33245	12,50	148	22,5	242	141	7,30	

Note: With extra wide chain bed.

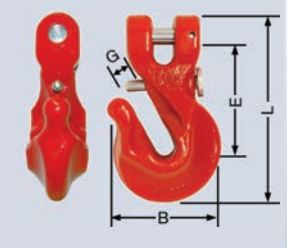
Trade Size	Article-No.	Working Load Limit [t max.]	Dimensions [mm]				Weight app. [kgs]	TWN 0827/1
			E	G	L	B		
8-8	F33201	2,00	61	9	101	61	0,54	
10-8	F33211	3,15	73	12	125	75	0,99	
13-8	F33221	5,30	95	15	160	95	2,18	
16-8	F33231	8,00	112	18	188	120	3,45	
20-8	F33246	12,50	148	22,5	242	141	7,35	

Note: With extra wide chain bed, complies to DIN 5692.

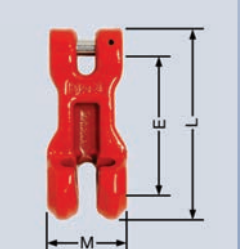
Trade Size	Article-No.	Working Load Limit [t max.]	Dimensions [mm]			Weight app. [kgs]	TWN 0851
			E	L	M		
6-8	F34910	1,12	54	81	32	0,21	
7-8	F34920	1,50	74	108	43	0,42	
8-8	F34925	2,00	80	115	46	0,56	
10-8	F34930	3,15	90	134	56	0,94	
13-8	F34940	5,30	117	175	72	2,10	
16-8	F34950	8,00	144	214	86	3,57	
18-8	F34960	10,00	162	241	98	5,40	
20-8	F34970	12,50	158	241	98	5,40	
22-8	F34980	15,00	198	295	118	9,00	
26-8	F34985	21,20	195	309	130	12,00	
32-8	F34990	31,50	240	381	160	19,00	

Clevis Shortening Claw



Shortening Components

Trade Size	Article-No.	Working Load Limit [t max.]	Dimensions [mm]						Weight app. [kgs]	TWN 0896
			E	E ₁	E ₂	B-Link				
6-8	F0896068	1,12	137	31	60	10	46	23	0,32	 <p>Shortening Device for fixed size Master Link</p>
8-8	F0896088	2,00	176	38	78	13	60	30	0,68	
10-8	F0896108	3,15	215	46	99	16	70	35	1,41	
13-8	F0896138	5,30	270	59	126	18	85	40	2,60	
16-8	F0896168	8,00	326	76	150	22	100	50	4,60	
18-8	F0896188	10,00	347	79	168	22	100	50	6,30	
22-8	F0896228	15,00	450	100	210	32	140	70	12,00	

Shackles

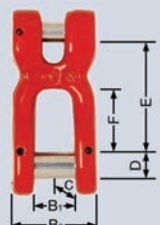
Trade Size	Article-No.	Working Load Limit [t max.]	Dimensions [mm]						Weight app. [kgs]	TWN 0861
			E	D	C	F	B ₁	B ₂		
10-8	F30601	3,15	64	16	32	36	21	47	0,61	 <p>Chain Coupling Shackle with Safety Bolt</p>
13-8	F30611	5,30	83	20	40	49	27	61	1,24	
16-8	F30621	8,00	99	24	48	56	33	75	2,10	
18-8	F30631	10,00	115	30	60	63	42	100	3,93	

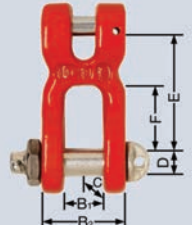
Trade Size	Article-No.	Working Load Limit [t max.]	Dimensions [mm]						Weight app. [kgs]	TWN 0862
			E	D	C	F	B ₁	B ₂		
10-8	F30600	3,15	64	16	32	36	21	47	0,67	 <p>Chain Coupling Shackle with Safety Bolt, Nut and Cotter Pin</p>
13-8	F30610	5,30	83	20	40	49	27	61	1,37	
16-8	F30620	8,00	99	24	48	56	33	75	2,28	
18-8	F30630	10,00	115	30	60	63	42	100	4,37	

Shackles

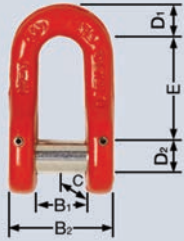
Trade Size	Article-No.	Nominal Size [DIN 82101]	Working Load Limit [t max.]	Dimensions [mm]						Weight app. [kgs]	TWN 0870
				E	D ₁	D ₂	C	B ₁	B ₂		
10-8	F30311	1	3,15	49	15	16	32	21	47	0,35	 <p>Bolt Shackle Type C</p>
13-8	F30321	1,6	5,30	61	19	20	40	27	61	0,74	
16-8	F30331	2,5	8,00	73	23	24	48	33	75	1,30	
18/20-8	F30341	4	12,50	91	29	30	60	42	96	2,60	
22-8	F30351	5	15,00	111	33	36	72	47	107	4,00	
26-8	F30361	6	21,20	120	37	39	78	53	121	5,70	
28-8	F30371	8	25,00	140	41	45	90	60	136	10,00	
32-8	F30381	10	31,50	147	45	48	96	66	150	10,50	
36-8	F30391	12	40,00	158	50	52	104	73	167	13,90	
40-8	F30401	16	50,00	185	55	60	120	81	185	20,50	
45-8	F30411	20	63,00	211	61	68	136	90	206	26,60	

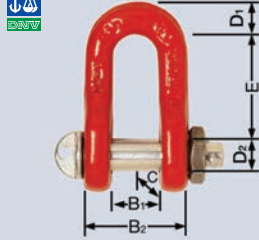
Trade Size	Article-No.	Nominal Size [DIN 82101]	Working Load Limit [t max.]	Dimensions [mm]						Weight app. [kgs]	TWN 0871
				E	D ₁	D ₂	C	B ₁	B ₂		
6-8*	Z04147	0,4	1,12	30	8	10	20	14	30	0,10	 <p>Safety Bolt Shackle Type C with Nut and Cotter Pin</p>
8-8	Z04145	0,6	2,00	36	10	12	24	17	37	0,20	
10-8	F30310	1	3,15	49	15	16	32	21	47	0,45	
13-8	F30320	1,6	5,30	61	19	20	40	27	61	0,84	
16-8	F30330	2,5	8,00	73	23	24	48	33	75	1,40	
18/20-8	F30340	4	12,50	91	29	30	60	42	96	3,10	
22-8	F30350	5	15,00	111	33	36	72	47	107	4,50	
26-8	F30360	6	21,20	120	37	39	78	53	121	6,30	
28-8	F30370	8	25,00	140	41	45	90	60	136	10,10	
32-8	F30380	10	31,50	147	45	48	96	66	150	12,30	
36-8	F30390	12	40,00	158	50	52	104	73	167	15,60	
40-8	F30400	16	50,00	185	55	60	120	81	185	22,20	
45-8	F30410	20	63,00	211	61	68	136	90	206	26,30	

*Finish: Electro galvanized, welded on nut.

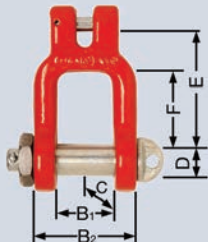
Trade Size	Article-No.	Working Load Limit [t max.]	Dimensions [mm]						Weight app. [kgs]	TWN 0897
			E	D ₁	C ₂	F	B ₁	B ₂		
6-8	F30586	1,12	70	20	39	46	35	65	0,47	 <p>Special Coupling Bolt Shackle with Safety Bolt, Nut and Cotter Pin</p>
8-8	F30596	2,00	70	20	40	46	35	65	0,54	

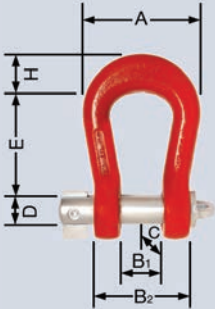

Shackles

Trade Size DIN 82016	Article-No.	Working Load Limit [t max.]	Dimensions [mm]							Weight app. [kgs]	TWN 0898
			E	D	H	C	B ₁	B ₂	A		
10	F38355	35	166	48	60	96	66	150	186	11,86	 <p>Cargo Shackle</p>
20	F38370	70	231	68	85	136	90	206	256	31,46	

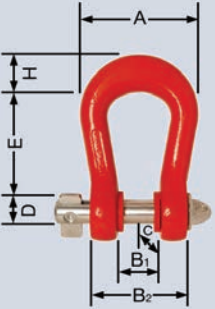
Trade Size DIN 82016	Article-No.	Working Load Limit [t max.]	Dimensions [mm]							Weight app. [kgs]	TWN 0898/1
			E	D	H	C	B ₁	B ₂	A		
10	F38357	35	171	38	60	96	48	150	186	11,62	 <p>Cargo Shackle with Bush</p>

Chain Tensioners

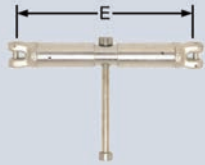
Trade Size	Article-No.	Norm. straight load (S_{TF}) [daN min.]	Lashing Capacity (LC) [kN max.]	Dimensions [mm]			Weight app. [kgs]	TWN 1450
				$E_{max.}$	$E_{min.}$	hub		
8-8	F34179	1800	40	345	270	75	2,10	 <p>Short Chain Tensioner acc. to DIN EN 12195-3</p>
10-8	F34199	2200	63	375	275	100	2,70	
13-8	F34189	2600	100	460	340	120	4,00	

Note: Can also be used in slings; also rated for lifting.

Trade Size	Article-No.	Norm. straight load (S_{TF}) [daN min.]	Lashing Capacity (LC) [kN max.]	Dimensions [mm]			Weight app. [kgs]	TWN 1451
				$E_{max.}$	$E_{min.}$	hub		
8-8	F34175	1800	40	345	270	75	2,50	 <p>Short Chain Tensioner with Ratchet acc. to DIN EN 12195-3</p>
10-8	F34195	2200	63	375	275	100	3,50	
13-8	F34185	2600	100	460	340	120	5,00	

Note: Can also be used in slings; also rated for lifting.

Trade Size	Article-No.	Norm. straight load (S_{TF}) [daN min.]	Lashing Capacity (LC) [kN max.]	Dimensions [mm]			Weight app. [kgs]	TWN 1452
				$E_{max.}$	$E_{min.}$	hub		
13-8	F341871	2600	100	675	445	230	7,20	 <p>Chain Tensioner (long lift) acc. to DIN EN 12195-3</p>
16-8	F34197	3100	160	835	555	280	11,80	

Note: Can also be used in slings; also rated for lifting.

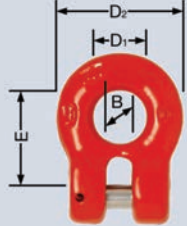

Special Sling Components

Trade Size	Article-No.	Working Load Limit [t max.]	Dimensions [mm]				Weight app. [kgs]	TWN 0812
			E	D ₁	D ₂	B		
6-8	F31700	1,12	31	17	39	8	0,10	 <p>Ringshackle</p>
8-8	F31710	2,00	37	21	50	11	0,20	
10-8	F31720	3,15	46	26	62	14	0,40	
13-8	F31730	5,30	59	33	79	18	0,87	
16-8	F31740	8,00	75	42	99	22	1,60	
18-8	F31750	10,00	79	47	111	25	2,50	
22-8	F31760	15,00	100	55	136	31	3,80	

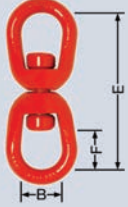
Trade Size	Article-No.	Working Load Limit [t max.]	Dimensions [mm]			Weight app. [kgs]	TWN 0845
			E	F	B		
6-8	F34000	1,12	108	27	30	0,33	 <p>Swivel</p>
8-8	F34010	2,00	168	44	44	1,33	
10-8	F34020	3,15	168	44	44	1,33	
13-8	F34030	5,30	184	46	51	2,10	
16-8	F34040	8,00	252	66	64	4,45	

Special Sling Components

New

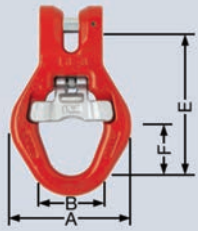
Trade Size	Article-No.	Working Load Limit [t max.]	Dimensions [mm]				Weight app. [kgs]	TWN 0869
			E	F	B	A		
13-8	F313800	5,30	142	57,5	65	122	1,92	 <p>Skip Suspension Link with Pin Coupling and forged Safety Latch</p>
16-8	F313850	8,00	141	57,5	65	122	1,92	

New

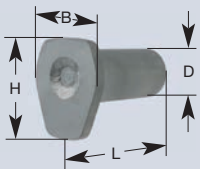
Trade Size	Article-No.	Dimensions [mm]				Weight app. [kgs]	TWN 0869/1
		L	D	B	H		
1	F31410	110	45	68	82	1,60	 <p>Container Centring Pivo</p>

Trade Size	Working Load Limit [t max.]		Dimensions [mm]				Weight app. [kgs]	TWN 0875
	from	to	L	D	F	B		
1	3,15	5,30		13	60	30	4,02	 <p>Reduction Assembly</p>
2	6,30	10,00		18	85	40	17,46	
3	12,50	20,00		26	120	60	-	

Note: Please indicate the dimension of the crane hook or crane hook no.





Special Sling Components

Trade Size	Article-No.	Dimensions [mm]								Weight app. [kgs]	TWN 0882
		E	A	D ₁	D ₂	B	C	F			
6-8	F48300	42	100	14	18	8	11	10	0,40		
8-8	F48303	56	130	18	22	10	15	12	0,80		
10-8	F48306	70	160	22	28	13	19	15	1,50		
13-8	F48309	91	210	28	40	16	25	20	3,40		
16-8	F48312	110	260	36	42	20	30	25	5,60		
18-8	F48313	130	290	40	54	23	34	25	8,40		
20-8	F48322	130	300	42	54	25	35	30	10,90		
22-8	F48315	140	330	46	56	28	39	35	15,20		
26-8	F48319	170	390	54	66	33	46	40	24,70		
32-8	F48321	210	480	68	80	40	54	50	47,40		
32-8	F48325	200	700	68	80	40	56	50	64,92		
Trade Size	Working Load Limit [t max.]		Breaking Force [kN min.]								
	$0^\circ < \beta \leq 45^\circ$	$45^\circ < \beta \leq 60^\circ$									
6-8	1,60	1,12	71								
8-8	2,80	2,00	124								
10-8	4,25	3,15	200								
13-8	7,50	5,30	340								
16-8	11,20	8,00	490								
18-8	14,00	10,00	628								
20-8	17,00	12,50	785								
22-8	21,20	15,00	950								
26-8	30,00	21,20	1.300								
32-8	45,00	31,50	1.960								

Balancer

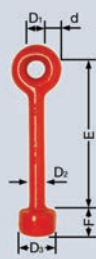
Special Sling Components

Trade Size	Article-No.	Working Load Limit [t max.]	Dimensions [mm]						Weight app. [kgs]	TWN 0892
			E	d	D ₁	D ₂	D ₃	F		
10-8	F34250	3,15	168	17	20	17	40	25	0,82	 <p>Key Hook</p>

Trade Size	Article-No.	Working Load Limit [t max.]	Dimensions [mm]						Weight app. [kgs]	TWN 0893	
			E	D	F	B	G	H			C
6-8	F08904	1,12	307	18	130	70	24	20	17	1,73	 <p>Isolation Assembly</p>
8-8	F08912	2,00	329	18	130	70	30	25	22	2,16	
10-8	F08898	3,15	371	18	130	70	37	32	28	3,25	
13-8	F08899	5,30	425	22	160	90	42	41	35	5,27	

Note: Isolates a power flow rate till max. 1.000 Volt.

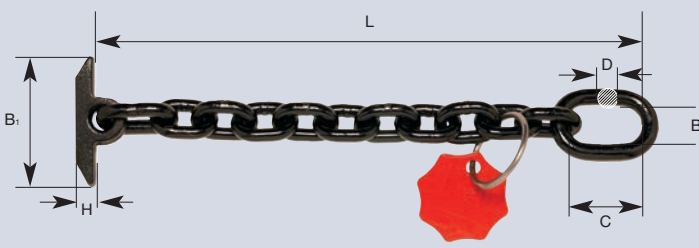
Trade Size	Article-No.	Working Load Limit [t max.]	Dimensions [mm]						Weight app. [kgs]	TWN 0894
			L	D	C	B	B ₁	H		
10-8	F08811	1,60	405,5	13	60	30	95	14,5	1,70	 <p>T-Handle Chain</p>
10-8	F08812	1,60	675,5	13	60	30	95	14,5	2,30	



Special Sling Components

Trade Size	Article-No.	Working Load Limit [t max.]	Dimensions [mm]					Weight app. [kgs]	TWN 0895
			E	D	F	G	A		
13-8	F30975	5,30	79	36	28	28	82	1,20	 <p>Swivel Adapter</p>

Note: Working load limit for vertical load only.



Lashing Chains

Trade Size	Article-No.	Lashing Capacity (LC) under straight load [kN max.]	Weight app. [kgs]	TWN 1400
8-8	F34171	40	8,50	 <p>Lashing Chain with Spindle Tensioner</p>
10-8	F34172	63	12,50	
13-8	F34173	100	21,00	
16-8	F34174	160	37,70	



Trade Size	Article-No.	Lashing Capacity (LC) under straight load [kN max.]	Weight app. [kgs]	TWN 1401
8-8	F34171R	40	8,50	 <p>Lashing Chain with Ratchet</p>
10-8	F34172R	63	12,50	
13-8	F34173R	100	21,00	



Magnet Chain Slings TWN 0601

Trade Size	Article-No.	Working Load Limit [t max.]	Working Length [mm] E	D-Link [mm]			Master-Link [mm]			Weight app. [kgs]	TWN 0601
				D ₁	F ₁	B ₁	D ₂	F ₂	B ₂		
16-8	F08945	21,30	776	45	260	155	20	90	45	21,5	
20-8	F08946	33,40	940	51	260	155	26	120	60	35,5	
22-8	F08947	40,25	1.002	57	300	165	26	120	60	46,0	
26-8	F08948	56,25	1.126	57	300	165	32	140	70	64,0	
32-8	F08961	85,20	1.362	63	330	165	40	180	90	108,0	

Note: The Magnet Chain Slings acc. to this works standard are made for safe lift of electro magnets.
 The dimensions, working load limits as well as the manufacturing proof- and break-force comply with the ASTM A391/A391M, the marking meets the requirement of the EN 818-1.
 The D-type master links and the B-type connecting- and intermediate links comply with DIN 5688-3.
 The ratio between working load to proof load to break load is 1 : 2 : 4.
 The maximum inclination angle is 30°.

Spare Parts and Accessories

Trade Size	Article-No.	Packaging Unit	Weight app. [kgs]	TWN 0904/0
6-8	F48694	1 set	0,01	 <p>Load Pin for Clevis Type Hooks</p>
8-8	F48352	1 set	0,01	
10-8	F48355	1 set	0,03	
13-8	F48358	1 set	0,07	
16-8	F48361	1 set	0,11	
18-8	F48364	1 set	0,20	
20-8	F48369	1 set	0,26	
22-8	F48367	1 set	0,31	
26-8	F48373	1 set	0,50	
32-8	F48371	1 set	0,91	



Trade Size	Article-No.	Packaging Unit	Weight app. [kgs]	TWN 0905 / 0906
10-8	F48036	1 set	0,07	 <p>Load-Spirol Pins for Chain Coupling Shackles and Chain Shackles</p>  <p>(TWN 0861, TWN 0870)</p>
13-8	F48039	1 set	0,14	
16-8	F48042	1 set	0,25	
18/20-8	F48045	1 set	0,44	
22-8	F48048	1 set	0,78	
26-8	F48051	1 set	1,05	
28-8	F48054	1 set	1,60	
32-8	F48057	1 set	2,02	
36-8	F48060	1 set	2,60	
40-8	F48063	1 set	3,89	

Trade Size	Article-No.		Packaging Unit	Weight app. [kgs]	TWN 0920 - 0922
	TWN 0854	TWN 0855/1			
6-8	F48420		1 set	0,02	 <p>Latch Set for Eye Hooks and Swivel Hooks</p>  <p>(TWN 0854, 0855/1)</p>
8-8	F48423		1 set	0,03	
10-8	F48426		1 set	0,04	
13-8	F48429		1 set	0,11	
16-8	F48469		1 set	0,19	
36-8		Z06163	1 set	0,80	
40-8		Z06164	1 set	1,00	
45-8		Z06165	1 set	1,40	
50-8		Z06166	1 set	1,90	





Spare Parts and Accessories

Trade Size	Article-No.	Packaging Unit	Weight app. [kgs]	TWN 1920
6-8	F486012	1 set	0,01	 <p>Spare Part Set for THI-LOK®</p>  <p>(TWN 1320)</p>
8-8	F486042	1 set	0,02	
10-8	F486072	1 set	0,04	
13-8	F486102	1 set	0,06	
16-8	F486132	1 set	0,11	

Trade Size	Article-No.	Packaging Unit	Weight app. [kgs]	TWN 1920
18-8	F48615	1 set	0,17	 <p>Spare Part Set for THI-LOK®</p>  <p>(TWN 1320)</p>
20-8	F48617	1 set	0,27	
22-8	F48619	1 set	0,28	
26-8	F48622	1 set	0,47	
32-8	F48625	1 set	0,85	

Trade Size	Article-No.	Packaging Unit	Weight app. [kgs]	TWN 0930-0932
10-8	F30451	1 set	0,13	 <p>Spare Part Set for chain couplings Bolt Shackle and C-Shackle</p>  <p>(TWN 0862, TWN 0871)</p>
13-8	F30461	1 set	0,25	
16-8	F30471	1 set	0,36	
18/20-8	F30481	1 set	0,97	
22-8	F30491	1 set	1,31	
26-8	F30501	1 set	1,99	
28-8	F30511	1 set	2,89	
32-8	F30521	1 set	3,69	
36-8	F30531	1 set	4,48	
40-8	F30541	1 set	6,65	
45-8	F30551	1 set	8,20	

Spare Parts and Accessories

Trade Size	Article-No.	Packaging Unit	Weight app. [kgs]	TWN 0950-0952
8-8	F48330	1 set	0,01	 <p>Spare Part Set for Shortening Hook</p>  <p>(TWN 0827/1)</p>
10-8	F48328	1 set	0,02	
13-8	F48329	1 set	0,03	
16-8	F48339	1 set	0,05	
20-8	F48345	1 set	0,10	



Trade Size	Article-No.	Packaging Unit	Weight app. [kgs]	TWN 0962	
13/16-8	F31404	1 set	0,28	 <p>Spare Set for Skip Suspension Link</p>  <p>(TWN 0869) Old version</p>	

Trade Size	Article-No.	Packaging Unit	Weight app. [kgs]	TWN 0967/0
6-8	F333700	1 set	0,01	 <p>Spare Pin for Clevis Self-Locking Hook</p>  <p>(TWN 0799)</p>
8-8	F333711	1 set	0,02	
10-8	F333721	1 set	0,03	
13-8	F333730	1 set	0,06	
16-8	F333741	1 set	0,17	
18/20-8	F0922057	1 set	0,22	

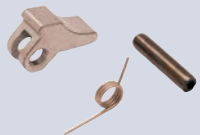
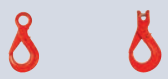

Spare Parts and Accessories

Trade Size	Article-No.	Packaging Unit	Weight app. [kgs]	TWN 0967/1
6-8	F329090	1 set	0,02	 <p>Trigger Set for Self-Locking Hooks</p>  <p>(TWN 0798, TWN 0799)</p>
8-8	F329190	1 set	0,03	
10-8	F329290	1 set	0,04	
13-8	F329390	1 set	0,06	
16-8	F329490	1 set	0,11	
18/20-8	F0922056	1 set	0,27	
22-8	F0922056	1 set	0,33	

Trade Size	Article-No.	Packaging Unit	Weight app. [kgs]	TWN 0968
13-8	F480131	1 set	0,07	 <p>Spare Pin for Skip Suspension Link</p>  <p>(TWN 0869) New version</p>
16-8	F480161	1 set	0,12	

Trade Size	Article-No.	Packaging Unit	Weight app. [kgs]	TWN 0969
13/16-8	F314081	1 set	0,20	 <p>Spare Set for Skip Suspension Link</p>  <p>(TWN 0869) New version</p>



Chain and Wire Rope Cutter TWN 0941

Function and Design

The mobile THIELE universal chain and wire rope cutting machine allows an easy cutting, mounting and inspection of chain and wire rope slings.

The THIELE universal chain and wire rope cutting machines can be easily and safely moved due to light steerable wheels and fulfil the latest accident prevention regulations (DGUV). The compact hydraulic unit is controlled by a foot switch, allowing the cutting of chain or wire rope due to fast interchangeable blades. The cutting machine has a lockable tool compartment and a large work top.



Drive:	Electro-hydraulic with 700 kN shearing force
Article-No.:	F48950
Voltage:	220/380 V 3 Ph. 50 Hz, 220 V 1 Ph. 50 Hz or 440 V 3 Ph. – 60 Hz, Export
Dimensions (L x W x H):	app. 1.100 x 920 x 1.500 mm (with closed protection cover)
Working Height:	app. 1.100 mm
Weight:	app. 270 kgs

Cutting Range

Round link chains according to EN 817-7, EN 818-2-8, 818-2-8, ASTM 391, ASTM 973 – grade 80 / 100 and DIN 22 252 up to 26 mm diameter, wire rope up to 30 mm diameter and with a strength of 1600 N/mm², higher strengths and larger diameters on request.

Accessories

- 1 set of tools for changing the blades,
- 2 sets of blades, one each for chains and wire rope



The chain and wire rope cutting machine has one of the above mentioned voltages. The hydraulic tank is filled with hydraulic oil. The oil level is to be checked regularly and refilled if necessary.

Special Accessories

- 1. Holding Clamp:** The holding clamp keeps the wire rope at a right angle to the cutting direction.
- 2. Stroke Adjustment:** With the stroke adjustment, the cutting stroke can be adjusted from 0 mm to 50 mm. The advantage is that a no load operation is avoided when cutting small diameters (working time is saved).
- 3. Wire Rope Clamp:** The wire rope clamp prevents the wire rope from falling onto the ground after it has been cut, which always has to be picked up (easier to work with and assists working time).



Spare Parts and Accessories

Trade Size	Article-No.	Packaging Unit	Weight app. [kgs]	TWN 0944
–	Z04575	–	0,01	 <p>Chain Card File</p> 

Note: Form to file the regular inspections of slings according to DIN EN standard.

Trade Size	Article-No.	Packaging Unit	Weight app. [kgs]	TWN 0945
–	Z03303	–	0,60	 <p>Assembly Set</p>

Note: Consisting of 6 punches in a plastic holder to disassemble chains from components. The complete set covers all sizes of the the THIELE Sling System.

Trade Size	Article-No.	Packaging Unit	Weight app. [kgs]	TWN 0946
–	F48856	–	0,20	 <p>Chain Gauge Set</p>

Note: For regular wear inspection of chain sizes 6-8 to 32-8.

Trade Size	Article-No.	Packaging Unit	Weight app. [kgs]	TWN 1402
–	Z07264	–	0,05	 <p>Identification Tag</p>

Note: Identification tag for lashing chains acc. to EN 12195-3.



THIELE Key Design

Mounted chain slings



TA 2 A / 10-8 - R e a c h - T W N 0856

	TA	2	A	/	10	-	8	T	2000	T W N	1340	/	1	R A L	9005	R A L	3003
THIELE chain slings	[]																
No. of legs (1...4)	[]																
Execution (master or intermediate link)	[]																
Trade size - grade	[]																
Type of assembly	[]																
T - THI-LOK® / R - ringshackle	[]																
Use length in mm (rounded up)	[]																
TWN of bottom components	[]																
Surface finish of chain	[]																
Standard: black coloured (RAL 9005)	[]																
Colour of components	[]																
Standard: red coloured (RAL 3003)	[]																

Always indicate the THIELE key design in case of order.

Example (Pic. in the middle): TA 2 A / 10-8 _ _ _ _ T W N 0856 (RAL 9005, RAL 3003).

Complement to THIELE key design for slings with shortening components:

(key design as above)	+1 VK	shortening claw with pin coupling (TWN 0851)
"	+1 VE/VK	shortening device (TWN 0896)
"		plus shortening claws (TWN 0851)
"	+1 VH	shortening hook (TWN 0827)
"	+1 VE/VH	shortening device (TWN 0896)
"		plus shortening hook (TWN 0827)
"	+1 VHS	shortening with pin coupling (TWN 0827/1)
"	+1 VEA/VHS	shortening device (TWN 0896)
		plus shortening hook with pin coupling (TWN 0827/1)
		No. of shortenings (only 2 legs off)

THIELE Key Design

Table of available components for mounted chain slings

Master Link*	... TWN 1313	Intermediate Link*	... TWN 0795
Master Link for single leg w. Pin Coupling	... TWN 0820		
Suspension Shackle for Skips	... TWN 0869		
Chain Coupling Bolt Shackle	... TWN 0862	Special Chain Coupling Shackle	... TWN 0861
Special Coupling Shackle	... TWN 0897	Foundry or Container Hook with Pin Coupling	... TWN 0859
Foundry Hook Cont. or Cont. Eye Hook*	... TWN 0856	Ringshackle	... TWN 0812
Bolt Shackle*	... TWN 0871		
Sling Hook w. Pin Coupl. and Safety Latch	... TWN 1340/1	Eye Slip Hook with Safety Latch*	... TWN 0858/1
	... TWN 0835/1		
Self-locking Eye Hook*	... TWN 0798	Self-locking clevis Hook	... TWN 0799
Special Chain Shackle*	... TWN 0870	THI-LOK®	... TWN 1320
Shortening Hook with Pin Coupling	... TWN 0827	Swivel Hook with Latch*	... TWN 0854
Shortening Hook w. Pin Coupling a. Safety Latch	... TWN 0827/1	Chain Swivel*	... TWN 0845

*For complete Chain Slings with THI-LOK®-Connecting Links.



Endless Chains



Form K11



Form K12



Form K22

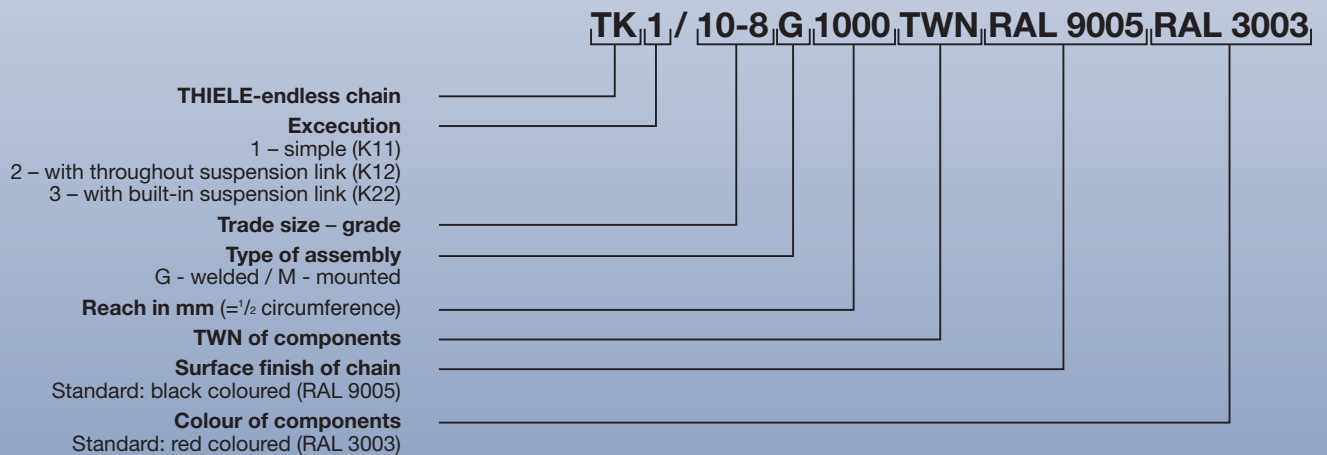

Please always indicate the THIELE key design in your order.

Example: TK 1 / 10-8 G 1000, RAL 9005 (K11-type with black coloured chain)















Examples for the THIELE Key Design

Type Sling	No. of Slings/ loops	Execution	Trade Size	Type of As-sembly	Reach [mm]	Component [TWN]	Surface Finish		Plant Standard [TWN]
							Chain [RAL-No.]	Components [RAL-No.]	
TA	1	A /	---	T	-----	1313	----	----	0449
TA	1	A /	---	T	-----	1340/1	----	----	0450/1
TA	1	A /	---	T	-----	0854	----	----	0454
TA	1	A /	---	T	-----	0856	----	----	0456
TA	1	A /	---	T	-----	0870	----	----	0458
TA	1	A /	---	T	-----	0871	----	----	0459
TA	1	A /	---	T	-----	0859	----	----	0460
TA	1	A /	---	T	-----	0861	----	----	0461
TA	1	A /	---	T	-----	0862	----	----	0462
TA	1	A /	---	T	-----	0858/1	----	----	0476/1
TA	2	A /	---	T	-----	1313	----	----	0529
TA	2	A /	---	T	-----	0835/1	----	----	0530/1
TA	2	A /	---	T	-----	0854	----	----	0534
TA	2	A /	---	T	-----	0856	----	----	0536
TA	2	A /	---	T	-----	0858/1	----	----	0566/1
TA	2	A /	---	T	-----	0870	----	----	0538
TA	2	A /	---	T	-----	0871	----	----	0539
TA	2	A /	---	T	-----	0859	----	----	0540
TA	2	A /	---	T	-----	0861	----	----	0541
TA	2	A /	---	T	-----	0862	----	----	0542
TK	1	1 /	---	M	-----	1313	----	----	0560
TA	2	A /	---	T	-----	1320	----	----	0563
TA	4	A /	---	T	-----	1314	----	----	0709
TA	4	A /	---	T	-----	1340/1	----	----	0710/1
TA	4	A /	---	T	-----	0854	----	----	0714
TA	4	A /	---	T	-----	0856	----	----	0716
TA	4	A /	---	T	-----	0858/1	----	----	0735/1
TA	4	A /	---	T	-----	0870	----	----	0718
TA	4	A /	---	T	-----	0871	----	----	0719
TA	4	A /	---	T	-----	0859	----	----	0720
TA	4	A /	---	T	-----	0861	----	----	0721
TA	4	A /	---	T	-----	0862	----	----	0722
TK	2	3 /	---	M	-----	1313	----	----	0731
TA	4	A /	---	T	-----	1320	----	----	0733



Examples for Chain Slings

1-Leg Chain Slings

<p>TWN 0449</p> 	<p>TWN 0450/1</p> 	<p>TWN 0453/1</p> 	<p>TWN 0454</p> 
<p>TWN 0456</p> 	<p>TWN 0458</p> 	<p>TWN 0459</p> 	<p>TWN 0460</p> 
<p>TWN 0461</p> 	<p>TWN 0462</p> 	<p>TWN 0473</p> 	<p>TWN 0475</p> 
<p>TWN 0477/1</p> 			





Examples for Chain Slings

2-Leg Chain Slings

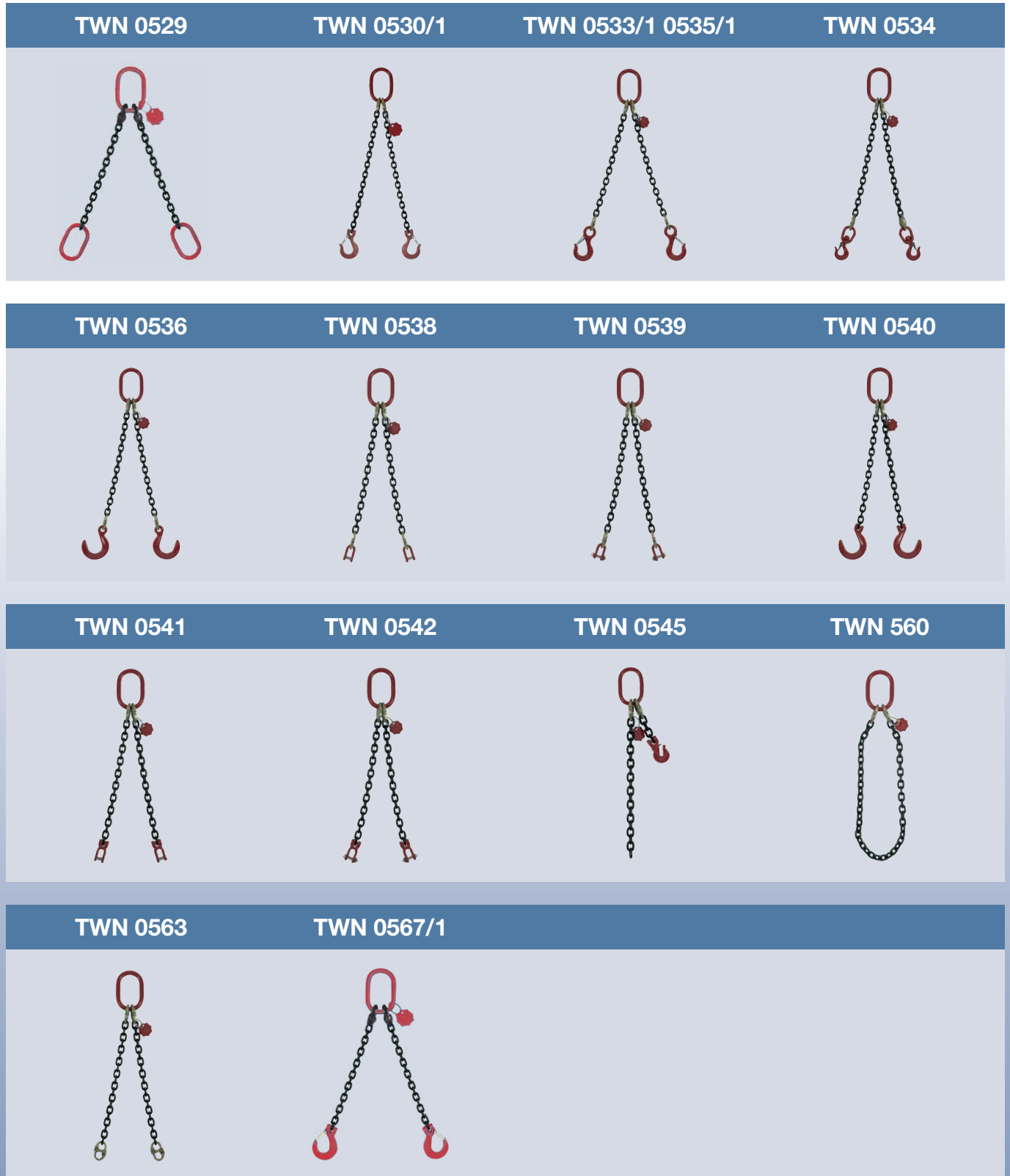

Examples for Chain Slings

4-Leg Chain Slings

TWN 0709



TWN 0710/1



TWN 0713/1 0715/1



TWN 0714



TWN 0716



TWN 0718



TWN 0719



TWN 0720



TWN 0721



TWN 0722



TWN 0730



TWN 0731



TWN 0733



TWN 0736/1





Offshore Products



In the offshore industry, chain slings are exposed to rough environmental conditions under strong dynamic loads. For this special application, THIELE as an authorized and certified manufacturer, supplies special calibrated welded-type chain slings as per DNV 2.7-1.

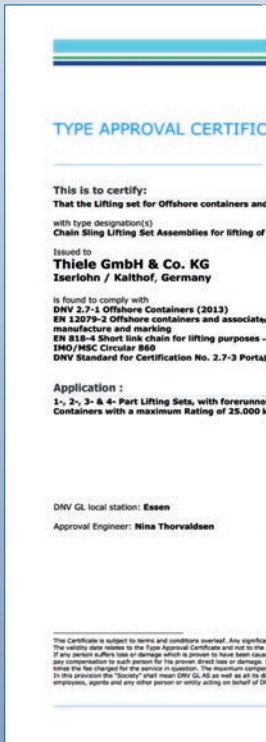
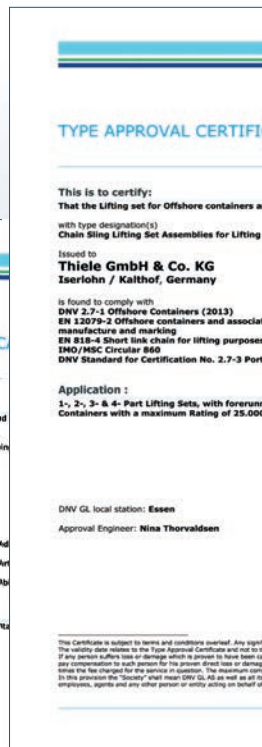

Operating Manual

WARNING!

- Sling Chains and Components can only be used, if user instructions and operating instructions have been read carefully and are completely understood.
- The indicated values of loads on the I.D. tags must not be exceeded.
- Due to improper use, chains can fail.

IT'S A QUESTION OF YOUR SAFETY
Death or injury can occur from improper use or maintenance!

1. Transport and Storing

All products must be protected during transportation, use, and storage in severe weather conditions.

2. Before first use

Assembling, disassembling and using should only be accomplished by authorized persons according to DGUV-R 100-500, Chapter 2.8 (in Germany)

Check the following points before using the chain sling for the first time:

- all test certificates exist (declaration of conformity, inspection certificate 3.1.B etc.); the chain sling you are going to use is the same that you ordered
- Slinging Chains and Tensioning Chains are provided with the CE label
- identification and working load limit marked on the chain sling are identical to the corresponding information indicated on the test certificate; all details concerning the chain sling have been entered into the chain card file
- The mounting is prohibited until it has been found out, that the machine in which should be built in, corresponds with the EC Directive for machines and its amendments (European rules and regulations).
- In suitable intervals, check the chain sling for damages or wear (depending upon severity of conditions slings shall be inspected for damage as frequently as prior to each lift. All supplied user instructions must be maintained and available for reference until the product is removed from service.

3. Warning and use advice

- EC Directive for Machines and its amendments as per 2006/42/EG
- Operation and use instructions for chain slings according to DIN 685 - Part 5, EN 818-6.
- Consult safety regulations for round steel chains used as slinging gear in hot dipped galvanizing plants (German rules and regulations) according to DGUV-R 109-004
- Consult Safety Regulations for Cranes according to DGUV52
- Consult load Suspension Devices for Lifting Operations (german rules and safety regulations) according to DGUV-R 100-500, Chapter 2.8
- Consult Safety certificate for riggers as per BGI 556
- Consult components for sling chains as per EN 1677-2
- Consult principles for test of industrial safety of lifting products
- Consult slinging of rod iron using steel round steel chains when loading and unloading sea-going ships
- Consult German rules and regulations VDI 2700-2701-2702

Special Components, hooks and clutching devices should only be used in straight tensile direction

Especially forbidden is:

- the combination of different grades when assembling (except tongs)
- the using of chain slings which do not correspond to grade 80
- overloading
- To use a combination of products with different working load limits, unless the working load noted on the I.D. tag is based on the weakest component.
- the use of twisted or knotted chains
- to use bolts or wires to connect components
- to use deformed components, rigid or elongated chains
- to lift or pull loads with sharp edges without padding the edges
- to drive equipment over chain sling
- to multiple wrap a chain around a loadhook or tension point
- to modify products by welding, burning, bending or other mechanical modifications
- to make inadmissible modifications, e.g. the use of a 2-leg sling chain with shortening hooks as a 4-leg sling chain
- to tip load a hook into a chain link
- to apply the load on the tip, side or back of the hook
- to load connectors (THI-LOK®) at one side
- to adjust chain links or products
- to adapt inclination over 60°
- to turn swivels or swivel hooks under load
- to weld Lifting Point screw type lifting eyes
- to exceed the indicated grip on lifting tongs
- the use of open or riveted repair links

It must be taken into consideration:

In the event that THIELE Chain and Components are used in an automated process, all parts should be designed correspondingly larger and inspected at more frequent intervals!

- the load to be lifted
- the free mobility of the hook's safety latches
- the use under chemical influences for example acids and steam is restricted or prohibited
- the influence of temperature on alloy chain and components
- shock load impacts the chain or fitting while lifting or securing
- any type of surface treatment to chain or fittings especially of hot dipped galvanizing can only be carried out by the manufacturer
- when lifting keep hands and other parts of body far away from the components
- be careful when locking hooks under load Danger of injury!
- when not in use sling chains must be hung on a rack
- ensure free mobility of chain slings or other devices in the crane hook
- when using hooks without latches pay special attention to the position of the hook placement
- to the installation position
- if necessary protect screw tensioners by locking elements to prevent automatic unlocking
- load claws with chains only on the bottom of the pocket claws
- protect chain by padding or wrapping sharp edges
- Safety latches should not be obstructed when hooks are loaded
- in case of shortening hooks, load chains must be loaded in the bowl of the hook
- hook openings must point away from the load being lifted
- that the hook up point and lifting hooks are compatible
- also be sure that the lifting components are suitable for the application

- do not sit loads on the chain sling
- reduction of working load limits is necessary when making lifts at severe angles
- consult charts when using alloy chain at extreme temperatures
- working load limits must be reduced when using endless and basket slings
- extreme caution should be used when using hooks for lifting molten metal or chemicals
- chain slings shall be loaded properly to avoid damage to chain and load
- keep personnel away from loads being lifted

4. Maintenance and tests

- The chain sling must be visually inspected before use. If damage is found, you must consult a chain expert according to DGUV-R 100-500.
- The product must be removed from service if the following damage is found:
 - unreadable tags
 - breaks or deformation
 - cuts, notches, grooves or cracks
 - strong corrosion
 - heating over the admissible temperature allowed
 - elongation of chain must not exceed 5% of manufacturer's published size
 - elongation of the overall chain length shall not exceed 5%
 - to determine wear rejection on the diameter of a link, you must measure the horizontal and the vertical and reject if reduction is more than 10%.
 - reject hooks if throat opening is opened greater than 10% of new hook or the safety latch does not seat properly
 - wear of hook eye or hook body exceed 5%
 - missing or damaged safety latch of the hook or shortening component
 - incorrect screw replacement on lifting eyes
 - incorrect or damaged bolts or turn off locking
- Don't repair chain slings yourself unless fully trained. Please contact the manufacturer or a repair expert. Use only original spare parts from THIELE.**

5. Regular inspections

Regular inspection shall include measurement and visual inspection and should be carried out once each year at minimum. Each third year inspection must include the crack detection (magna flux).

On a new chain, you must set up chain card index that shall contain a description of the chain as well as the identity of the certificate. The inspection schedule must be fixed. The condition of sling chains or tensioning chains and their accessories must be noted at each inspection. If damage is repaired, all repairs and details must be noted on the chain card.



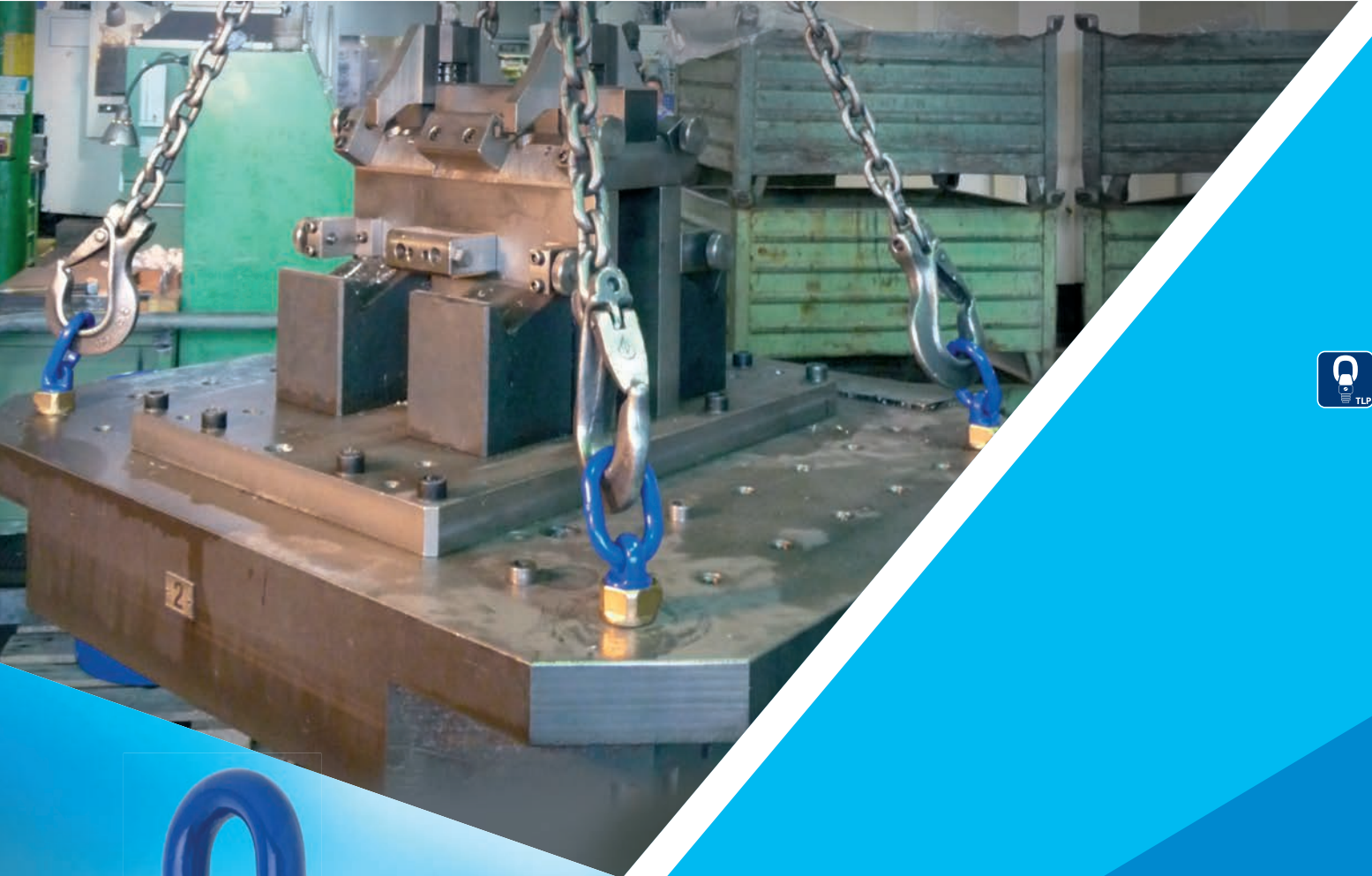

THIELE Lifting Points



Product Overview Lifting Points

TWN 0121/1 	TWN 0122 	TWN 0123 	TWN 0127 	TWN 1120 
TWN 1830 	TWN 1884 	TWN 1890 		

Page 120-125

Lifting Points, Screwed Type

TWN 0119 	TWN 0124 	TWN 0850/1 	TWN 1872 	TWN 1882 
TWN 1473 	TWN 1880 	TWN 1471 		

Page 130-135

Lifting Points, Weld-on Type

TWN 0301 	TWN 0302 	TWN 0304 	TWN 0308 	TWN 0321 
TWN 0323 				

Page 140-141

Hitches



Selection Criteria for Lifting Points

1. Determine the **weight of the load** to lift.
2. Select the **number of necessary lifting points**, depending on the number of sling-legs of the lashing chain and the number of available fitting positions (see pictographs on pages 116-119 and 126-129).
3. Consider the **reduction factors for the inclination angles and application temperature** (see operating manual).
4. Select the **suitable lifting point**, taking the type of application and the under point 3 determined working load limit under consideration.







Working Load Limit Table for Lifting Points, Screwed Type

			TWN 0121/1 Lifting Point, swivel type				TWN 0122 Lifting Point											
Application	Inclination Angle β	No. of Legs																
			Working Load Limits in [t max.]															
Marking					1,12	2	3,15	5,3			3,15	5,3	8	15	21,2	25	31,5	36
Screw Size					M16	M20	M24	M30			M16	M20	M30	M36	M42	M45	M56	M56
	0°	1			1,12	2	3,15	5,3			3,15	5,3	8	15	21,2	25	31,5	36
	0°	2			2,24	4	6,3	10,6			6,3	10,6	16	30	42,4	50	63	72
	90°	1			1,12	2	3,15	5,3			3,15	5,3	8	15	21,2	25	31,5	36
	90°	2			2,24	4	6,3	10,6			6,3	10,6	16	30	42,4	50	63	72
	0-45°	2			1,6	2,8	4,25	7,5			4,25	7,5	11,2	21,2	30	33,5	45	50
	45-60°	2			1,12	2	3,15	5,3			3,15	5,3	8	15	21,2	25	31,5	36
	unbalanced ¹⁾	2			1,12	2	3,15	5,3			3,15	5,3	8	15	21,2	25	31,5	36
	0-45°	3+4			2,36	4,25	6,7	11,2			6,7	11,2	17	31,5	45	50	67	75
	45-60°	3+4			1,7	3	4,75	8			4,75	8	11,8	22,4	31,5	37,5	47,5	53
	unbalanced ¹⁾	3+4			1,12	2	3,15	5,3			3,15	5,3	8	15	21,5	25	31,5	36

¹⁾Reduced working load limit acc. to DIN 685-5.













TWN 0123 Lifting Point						TWN 0127 Lifting Point MDB					
											
Working Load Limits in [t max.]											
			1,12	2	3,15					3,15	5,3
			M16	M20	M24					M20	M24
			1,12	2	3,15					3,15	5,3
			2,24	4	6,3					6,3	10,6
			1,12	2	3,15					3,15	5,3
			2,24	4	6,3					6,3	10,6
			1,6	2,8	4,25					4,25	7,5
			1,12	2	3,15					3,15	5,3
			1,12	2	3,15					3,15	5,3
			2,36	4,25	6,7					6,7	11,2
			1,7	3	4,75					4,75	8
			1,12	2	3,15					3,15	5,3



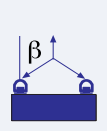

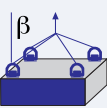
Working Load Limit Table for Lifting Points, Screwed Type

			TWN 1120 TITAN Lifting Point								TWN 1830 X-TREME Lifting Point											
Application	Inclination Angle β	No. of Legs																				
			Working Load Limits in [t max.]																			
Marking			0,3	0,45	0,6	1,4	2,5	3,5	6,7	8	0,45	0,6	1,4	2,5	3,5	5,3	8	10	12,5	12,5	17	17
Screw Size			M8	M10	M12	M16	M20	M24	M30	M36	M10	M12	M16	M20	M24	M30	M36	M42	M45	M48	M56	M64
	0°	1	0,3	0,45	0,6	2,1	3	6	7,1	12,5	0,9	1,2	2,8	5,3	7	10	15	18	20	20	28	28
	0°	2	0,6	0,9	1,2	4,2	6	12	14,2	25	1,8	2,4	5,6	10,6	14	20	32	36	40	40	56	56
	90°	1	0,3	0,45	0,6	1,4	2,5	3,5	6,7	8	0,6	0,7	1,7	2,8	4	6,3	9,5	12,5	15	16	22	22
	90°	2	0,6	0,9	1,2	2,8	5	7	13,4	16	1,2	1,4	3,4	5,6	8	12,6	19	25	30	32	44	44
	0-45°	2	0,42	0,63	0,85	2	3,55	5	9	11,2	0,85	1	2,4	4,0	5,7	8,9	13,4	17,7	21,2	22,6	31,1	31,1
	45-60°	2	0,3	0,45	0,6	1,4	2,5	3,55	6,7	8	0,6	0,7	1,7	2,8	4,0	6,3	9,5	12,5	15	16	22	22
	unbalanced ¹⁾	2	0,3	0,45	0,6	1,4	2,5	3,55	6,7	8	0,6	0,7	1,7	2,8	4,0	6,3	9,5	12,5	15	16	22	22
	0-45°	3+4	0,63	0,95	1,25	3	5,3	7,1	14	17	1,3	1,5	3,6	5,9	8,5	13,4	20,2	26,5	31,8	33,9	46,7	46,7
	45-60°	3+4	0,45	0,67	0,9	2,1	3,8	5,3	10	11,8	0,9	1,1	2,6	4,2	6,0	9,5	14,3	18,8	22,5	24	33	33
	unbalanced ¹⁾	3+4	0,3	0,45	0,6	1,4	2,5	3,55	6,7	8	0,6	0,7	1,7	2,8	4,0	6,3	9,5	12,5	15	16	22	22

¹⁾Reduced working load limit acc. to DIN 685-5.



New

TWN 1884
KE Eye Bolt



TWN 1890
XS-Lifting Point



Working Load Limits in [t max.]

		1,7	2,5												
		M16	M20 ²⁾	0,63	1	1,5	2,5	4	6	8	10	12			
				M10	M12	M16	M20	M24	M30	M36	M42	M48 ²⁾			
WORLDWIDE HIGHEST WORKING LOAD LIMIT!		1,7	2,5	0,63	1	1,7	2,5	4,0	6,0	8,0	10,0	-			
		3,4	2,5	1,26	2	3,4	5,0	8,0	12	16,0	20,0	-			
		1,7	2,5	0,63	1	1,7	2,5	4,0	6,0	8,0	10,0	-			
		3,4	5	1,26	2	3,4	5	8,0	12	16,0	20,0	-			
		2,4	3,55	0,9	1,4	2,4	3,5	5,7	8,5	11,2	14,0	-			
		1,7	2,5	0,63	1	1,7	2,5	4,0	6,0	8,0	10,0	-			
		1,7	2,5	0,63	1	1,7	2,5	4,0	6,0	8,0	10,0	-			
		3,57	5,25	1,3	2,1	3,6	5,3	8,5	12,5	17,0	21,2	-			
		2,55	3,75	1	1,5	2,6	3,8	6,0	9,0	11,8	15,0	-			
		1,7	2,5	0,63	1	1,7	2,5	5,0	6,0	8,0	10,0	-			

²⁾In development.



Lifting Points, Screwed Type

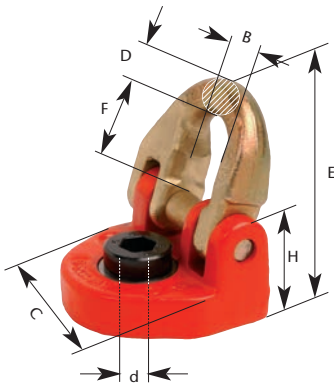

Rotating Lifting Point TWN 0121/1

The two forged parts make this lifting point particularly sturdy for lifting, moving and securing loads.

Our TWN 0121/1 lifting point features full load working load limit in all tension directions, and can be rotated 360° and swivelled 180°. The THI-LOK® half with electrolytic treatment has a high corrosion-resistancy.

This DGUV-approved safety component that moves high value machinery or steel elements has undergone 100% crack-testing.

Finish: RAL 3003, electro galvanized and yellow chromated.



Screw Size d [mm]	Article-No.	Working Load Limit [t max.]	Thread Length G [mm]	Dimensions [mm]									Weight app. [kgs]
				E	F	A	C	H	B	D	NG		
M16	F35000	1,12	25	65	30	61	65	38	22	12	6-8	0,70	
M20	F35010	2,00	30	85	40	79	82	49	28	15	8-8	1,50	
M24	F35020	3,15	36	98	45	92	101	59	33	19	10-8	2,60	
M30	F35030	5,30	50	120	53	113	125	72	45	25	13-8	4,60	

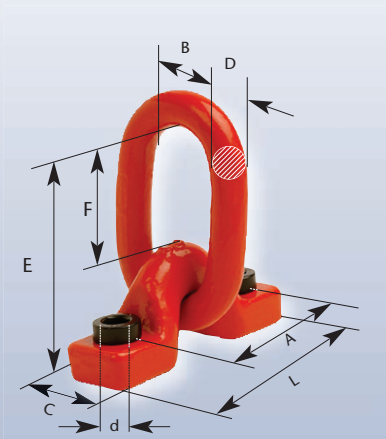

Lifting Point TWN 0122

Our engineers have developed a lifting point for mechanical engineering and plant construction that is distinctive in its compact design. The extra wide link simplifies hooking-in the broadest variety of hook types which makes transportation fast, smooth and easy. The full working load limit in every pulling direction of tension enables unlimited functionality, even with extremely heavy loads. Delivery includes 100% crack-tested and high strength special screws.

Finish: RAL 3003.



Screw Size d [mm]	Article-No.	Working Load Limit [t max.]	Thread Length G [mm]	Dimensions [mm]									Weight app. [kgs]
				E	F	A	C	L	D	B	NG		
M16	F35070	3,15	25	112	57	90	38	130	18	40	10-8	1,47	
M20	F35075	5,30	36	149	80	115	45	165	22	50	13-8	2,80	
M30	F35080	8,00	50	183	93	150	55	212	26	65	16-8	5,90	
M36	F35095	15,00	53	217	105	175	72	255	36	80	22-8	11,40	
M42	F35098	21,20	67	262	132	200	90	295	45	100	26-8	19,30	
M45	F35101	25,00	67	262	132	200	90	295	45	100	28-8	20,00	
M56	F35102	31,50	88	336	193	230	100	330	48	110	32-8	32,00	
M56	F35285	36,00	88	336	193	230	100	330	48	110	34-8	32,00	

Lifting Points, Screwed Type

Lifting Point TWN 0123

Our TWN 0123 threaded lifting point is easy to mount. All you need is a threaded bore hole. This captive unit features compact construction and only requires minimum assembly space. The attachment link is optionally available as a master link or intermediate link, making it adaptable to the specific job at hand. This means we have the right solution for your requirements, even at low mounting heights. The lifting point is constructed of high-strength tempered and powder-coated steel.

Finish: RAL 3003.

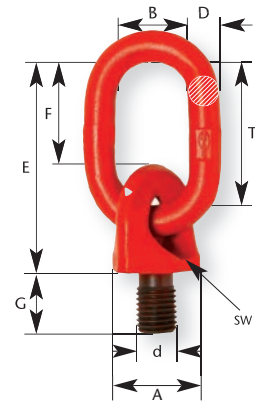

Screw Size d [mm]	Article-No.	Working Load Limit [t max.]	Thread Length G [mm]	Dimensions [mm]								Weight app. [kgs]
				E	F	D	T	B	SW	A	NG	
M16	F34110	1,12	30	113	52	16	70	35	46	60	6-8	0,73
M16	F34115	1,12	30	153	92	16	110	60	46	60	6-8	1,00
M20	F34120	2,00	38	113	52	16	70	35	46	60	8-8	0,95
M20	F34121	2,00	38	153	92	16	110	60	46	60	8-8	1,12
M24	F34130	3,15	35	128	67	18	85	40	46	60	10-8	1,04
M24	F34131	3,15	45	153	92	18	110	60	46	60	10-8	1,39

Lifting Point MDB TWN 0127

The delivery of our precision-tooled threaded TWN 0127 lifting point includes 100% crack-tested screws. It can be mounted and removed very quickly using commercial available tools. The largest surface contact is subsequently ensuring highly effective attachment thanks to the flat contact surface of the bolt-on bracket and a mirrored screw head surface.

Finish: RAL 3003.

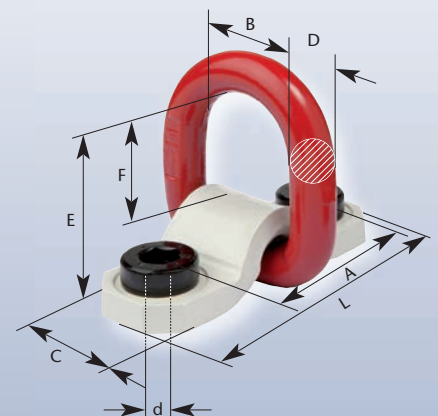

Screw Size d [mm]	Article-No.	Working Load Limit [t max.]	Thread Length G [mm]	Dimensions [mm]								Weight app. [kgs]
				E	F	A	C	L	D	B	NG	
M20	F35157	3,15	39	68	48	90	44	130	18	48	10-8	1,10
M24	F35158	5,30	36	113	69	110	60	160	24	66	13-8	2,70



Lifting Points, Screwed Type

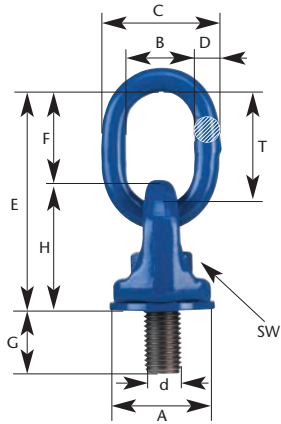

The TITAN Lifting Point TWN 1120

is capable to lift with the nominal working load limit in all directions. The coupling link is free moveable in all directions. It rotates easily due to the special collarbush and gliding washer, made from stainless steel.

It is built as a compact one-piece unit, it requires less mounting space.

The TITAN lifting point allows a fast and easy assembling with commercially available tools. Other screw lengths are available upon request. A plastic cover protects the screw during transportation and storage.

100% crack-tested. DGUV-approved.

Note: Does not swivel under load!

Finish: RAL 5002.



Screw Size d [mm]	Article-No.	Working Load Limit [t max.]	Thread Length G [mm]	Dimensions [mm]								Weight app. [kg]	
				E	F	D	T	B	A	C	H		SW
M8	F34405	0,30	19	95	40	10	50	28	43	50	55	13	0,40
M10	F34390	0,45	19	95	40	10	50	28	43	50	55	16	0,41
M12	F34395	0,60	24	95	40	10	50	28	43	50	55	18	0,43
M16	F34400	1,40	29	95	40	10	50	28	43	50	55	24	0,47
M20	F34410	2,50	33	115	49	12	60	34	54	60	66	30	0,79
M24	F34420	3,50	40	135	55	16	70	40	65	74	80	36	1,50
M30	F34430	6,70	52	167	66	18	85	50	85	93	101	46	3,00
M36	F34440	8,00	66	212	92	22	115	50	96	107	120	55	4,80

The right turn!



Lifting Points, Screwed Type

The X-TREME Lifting Point TWN 1830

is equipped with a ball bearing system. It has a special wide coupling link which enables an easy slinging of bigger hooks. It is particularly well suited for loads that have to be turned or flipped. The octagonal shap of the subpart enables an easy assembling with a common hand tool. 100% magnetic crack-tested. According to the principles of the BG GS-0A-15-04

Like the TITAN lifting point, the X-TREME lifting point is capable to lift in all directions. The X-TREME lifting point is not suitable for permanent rotations under load.

Finish: RAL 5002, zinc lamella coating.

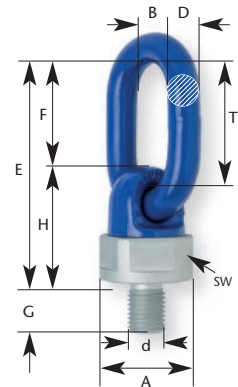

Screw Size d [mm]	Article-No.	Working Load Limit			Thread Length G [mm]	Dimensions [mm]								Weight app. [kg]
		Vertical Y [t max.]	Extreme Z [t max.]	Hinged X [t max.]		E	F	D	T	B	A	SW	H	
M10	F34306	0,9	0,45	0,6	15	101	47	13	55	33	39	36	55	0,48
M12	F34307	1,2	0,6	0,7	18	101	47	13	55	33	39	36	55	0,49
M16	F34300	2,8	1,4	1,7	20	101	47	13	55	33	39	36	55	0,50
M20	F34310	5,3	2,5	2,8	25	121	59	16	70	34	50	46	63	0,90
M20	F34312				50	121	59	16	70	34	50	46	63	1,00
M24	F34320	7	3,5	4	30	148	72	18	85	40	57	50	76	1,50
M24	F34321				90	148	72	18	85	40	57	50	76	1,70
M30	F34330	10	5,3	6,3	40	171	83	22	100	50	73	65	88	2,70
M36	F34340	15	8,0	9,5	50	179	81	22	100	50	83	70	98	3,60
M36	F34341				63	179	81	22	100	50	83	70	98	3,80
M36	F34343				70	179	81	22	100	50	83	70	98	3,90
M42	F34350	18	10	12,5	60	244	116	32	140	70	106	95	128	8,30
M45	F34353	20	12,5	15	65	244	116	32	140	70	106	95	128	8,40
M48	F34355	20	12,5	16	68	244	116	32	140	70	106	95	128	8,60
M56	F34360	28	17	22	78	251	116	32	140	70	116	95	135	10,00
New M64	F34363	28	17	22	96	251	116	32	140	70	116	95	135	11,00

Note: Variable screw lengths up to 5 x d available for thread diameters M20, M24, M30, M36.

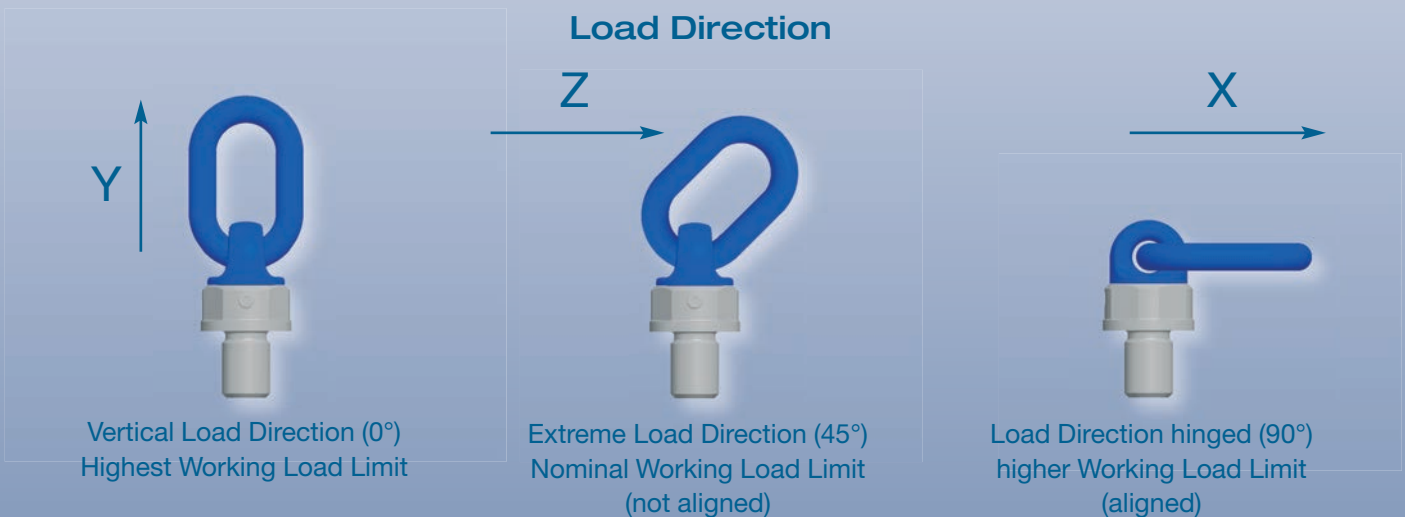



Lifting Points, Screwed Type



New KE Eye Bolt TWN 1884

The pivotable eccentric eye bolt with ball bearing type TWN 1884 is patented and has a large ring for connecting of larger hooks or other lifting components. The eccentric positioned eye enables an easy mounting with a standard hexagon socket. The unique in forged ellipses gives the user the safety of using a THIELE high quality product.

The KE eye bolt is 100% crack tested and complies with the test requirements of the DGUV.

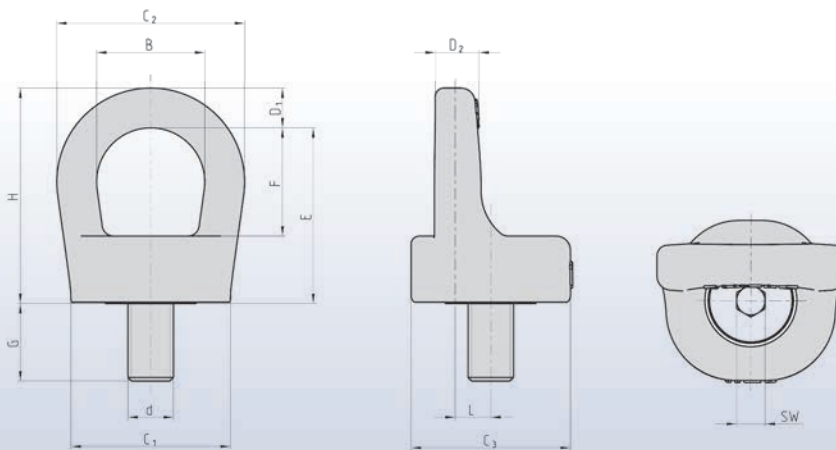

Screw Size d [mm]	Working Load Limit [t max.]	Article-No.	Thread Length G [mm]	Dimensions [mm]											Weight app. [kg]
				E	F	B	D ₁	D ₂	H	L	C ₁	C ₂	C ₃	SW	
M16	1,70	F38010	27	61,5	38	38	14	15	75,5	12,5	56	66	56	10	0,66
M20*	2,50	F38020	33	70	42	42	16	17	86	15	64	74	61	12	0,99

*In development.



Lifting Points, Screwed Type

XS Lifting Point TWN 1890

A piece of individualism, combined with economic production process for more safety. Our XS lifting point TWN 1890 has a 100% nominal working load limit in all load directions.

It can also be rotated by 360° and swivelled by 180°. Our engineers designed a lifting point which guarantees a fast and uncomplicated mounting and removal using a standard open-end spanner. The extrawide bow enables load hooks of a large nominal size to be used for slinging without any difficulty.

The XS lifting point is especially designed for the exchange of the screws and therefore screw lengths.



Finish: RAL 5002, zinc lamella coating.

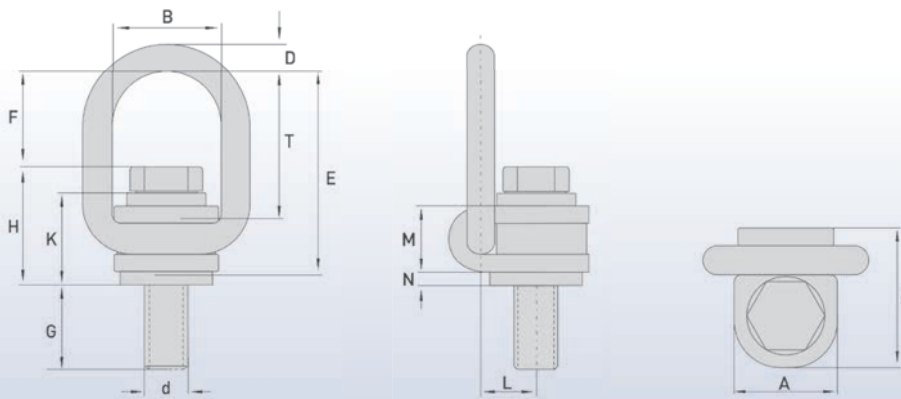











	Screw Size d [mm]	Working Load Limit [t max.]	Article-No.	Thread Length G [mm]	Dimensions [mm]										Weight app. [kg]
					E	F	D	T	B	A	C	H	K	L	
New	M10	0,63	F35243	17	71	37	8,5	53	35	32	43	35	28	17	0,29
New	M12	1,00	F35244	22	71	36	8,5	53	35	32	43	36	28	17	0,31
	M16	1,70	F35245	28	98	46	13	70	50	48	64	52	42	25	0,95
	M20	2,50	F35246	38	98	44	13	70	50	48	64	55	42	25	1,10
	M24	4,00	F35247	40	134	70	16	102	58	50	71	64	49	28	1,70
	M30	6,00	F35249	44	149	73	20	110	70	65	88	75	57	35	3,10
	M36	8,00	F35250	64	149	70	20	140	70	67	88	79	57	35	3,50
New	M42	10,00	F35251	74	191	98	24	145	84	81	106	93	67	43	6,10
	M48*	12,00	F35252	—	—	—	—	—	—	—	—	—	—	—	—

*In development.

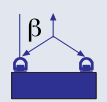

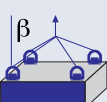
Working Load Limits for Lifting Points, Weld-on Type

			TWN 0119 Lifting Point								TWN 0124 Lifting Point with Fixing Spring								
Application	Inclination Angle β	No. of Legs	Working Load Limit [t max.]																
			Marking		1,12	2	3,15	5,3	8	15	31,5	50			1,12	2	3,15	5,3	
																			
																			
	0°	1	1,12	2	3,15	5,3	8	15	31,5	50			1,12	2	3,15	5,3			
	0°	2	2,24	4	6,3	10,6	16	30	63	100			2,24	4	6,3	10,6			
	90°	1	1,12	2	3,15	5,3	8	15	31,5	50			1,12	2	3,15	5,3			
	90°	2	2,24	4	6,3	10,6	16	30	63	100			2,24	4	6,3	10,6			
	0-45°	2	1,6	2,8	4,25	7,5	11,2	21,2	45	71			1,6	2,8	4,25	7,5			
	45-60°	2	1,12	2	3,15	5,3	8	15	31,5	50			1,12	2	3,15	5,3			
	unbalanced	2	1,12	2	3,15	5,3	8	15	31,5	50			1,12	2	3,15	5,3			
	0-45°	3+4	2,36	4,25	6,7	11,2	17	31,5	67	106			2,36	4,25	6,7	11,2			
	45-60°	3+4	1,7	3	4,75	8	11,8	22,4	47,5	75			1,7	3	4,75	8			
	unbalanced	3+4	1,12	2	3,15	5,3	8	15	31,5	50			1,12	2	3,15	5,3			



New

TWN 0850/1
Excavator Hook



TWN 1872
Lifting Point



Working Load Limit in
[t max.]

		1,2	2	3	5	8	10												
												4	6,7						
												4	6,7						
												8	13,4						
												4	6,7						
												8	13,4						
												5,6	9,5						
												4	6,7						
												4	6,7						
												8,5	14,2						
												6	10						
												4	6,7						



Working Load Limits for Lifting Points, Weld-on Type

Lashing Capacity for Lashing Points, Weld-on Type

			TWN 1882 Lifting Point „Compact“ with Fixing Spring					TWN 1471 Lashing Point ZK Module				
Application	Inclination Angle β	No. of Legs										
Marking			1,5	2,5	4	6,7	10			5.000	10.000	
	0°	1	1,5	2,5	4	6,7	10					
	0°	2	3	5	8	13,4	20					
	90°	1	1,5	2,5	4	6,7	10			5.000	10.000	
	90°	2	3	5	8	13,4	20					
	0-45°	2	2,1	3,5	5,6	9,4	14					
	45-60°	2	1,5	2,5	4	6,7	10					
	unbalanced	2	1,5	2,5	4	6,7	10					
	0-45°	3+4	3,15	5,25	8,4	14,1	21					
	45-60°	3+4	2,25	3,75	6	10,1	15					
	unbalanced	3+4	1,5	2,5	4	6,7	10					



New

TWN 1473
Lashing Point



New

TWN 1880
Lashing Point „Compact“ with Fixing Spring



Lashing Capacity (LC)
[daN max.]

		8.000	13.500					3.000	5.000	8.000	13.500		
		8.000	13.500					3.000	5.000	8.000	13.500		



Lifting Points, Weld-on Type

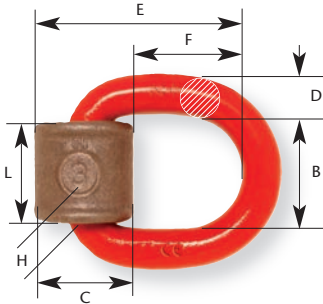

Lifting Point TWN 0119

Highest safety due to the use of high-tensile steel.

Our DGUV-approved attachment point features 4-times safety factor against breakage in all load directions and is available with a working load limit of up to 50 tonnes. Its universal application for lifting and lashing make this component a true allrounder. It can be welded easily and quickly to any steel construction thanks to its pre-aligned weld joint on the weld-on bracket and the accompanying welding instructions.

Finish: RAL 3003.



Trade Size	Article-No.	Working Load Limit [t max.]	Lashing Capacity (LC) [daN max.]	Dimensions [mm]							Weight app. [kgs]
				E*	F*	C	L	H	D	B	
6-8	F35103	1,12	2200	59	31	32	32	28	12	36	0,24
8-8	F35113	2,00	4000	69	37	38	38	33	14	42	0,46
10-8	F35123	3,15	6300	84	46	45	44	38	18	48	0,63
13-8	F35133	5,30	10000	120	69	60	60	51	24	66	1,90
16-8	F35143	8,00	16000	127	66	68	65	61	28	72	2,67
22-8	F35163	15,00	-	178	98	96	109	80	39	120	8,09
32-8	F35183	31,50	-	292	174	145	165	118	56	180	27,30
40-8	F35193	50,00	-	371	228	186	210	145	72	230	60,00

*E- and F-Dimensions vertical to the welding level.

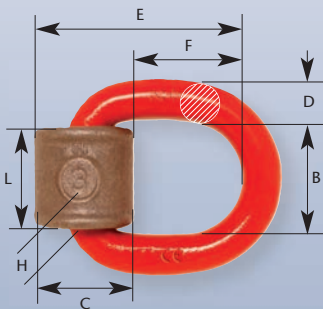

Lifting Point with Spring TWN 0124

This lifting point is easily and quickly welded to any steel construction. The weld-on bracket is already prepared at delivery to accommodate the required weld joint. An inserted spring holds the D-link in the desired position. The resulting noise reduction makes this lifting point particularly suited for utilisation as a load securing lashing point.

It also simplifies attachment to the pre-aligned lifting point.

This lifting point is certified by DGUV.

Finish: RAL 3003.



Trade Size	Article-No.	Working Load Limit [t max.]	Lashing Capacity (LC) [daN max.]	Dimensions [mm]							Weight app. [kgs]
				E*	F*	C	L	H	D	B	
6-8	F35107	1,12	2200	56	30	32	32	28	12	36	0,25
8-8	F35110	2,00	4000	67	37	38	38	33	14	42	0,43
10-8	F35124	3,15	6300	81	45	45	44	38	18	48	0,72
13-8	F35139	5,30	10000	117	69	60	60	54	24	66	1,90
16-8	F35144	8,00	16000	122	67	68	65	61	28	72	2,80

*E- and F-Dimensions vertical to the welding level.

Lifting Points, Weld-on Type

Excavator Hook TWN 0850/2

Uniting stability, functionality and safety.

The TWN 0850/2 weld-on hook is a component that is relevant for safety and is primarily welded onto earth-moving machinery extension arms, trusses or excavation buckets in applications involving the lifting and moving of loads. The hook and the safety latch both feature forged construction, ensuring robust, reliable, risk-free handling. Our TWN 0850/2 weld-on hook can bear loads of up to 10 tonnes and is delivered with all the necessary documentation.

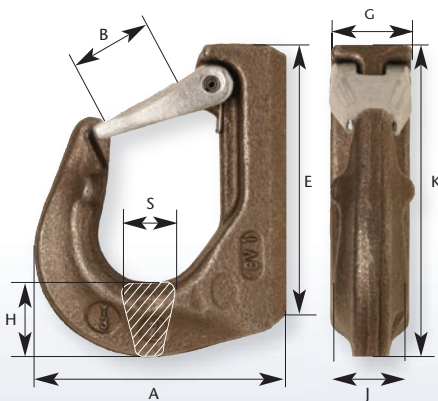

Finish: Self colored.
Pic.: Type GH2.

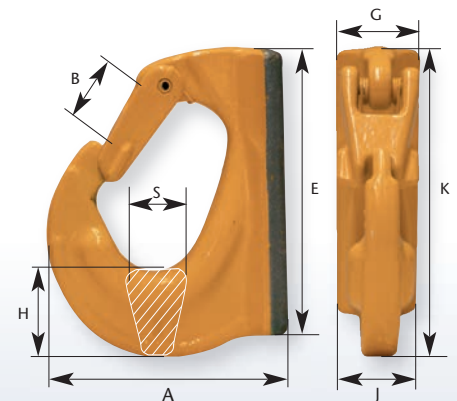

Finish: Yellow.
Pic.: Type for Trade Size from GH3.

Trade Size	Article-No.		Working Load Limit [t max.]	Dimensions [mm]								Weight app. [kgs]
	yellow	self-coloured		B	E	F	G	H	J	K	S	
GH1	F32770	F32751*	1,12	25	78	77	26	28	24	108	19	0,52
GH2	F32771	F32752*	2,00	33	85	97	34	28	30	114	20	0,70
GH3	F32772	–	3,00	33	64	105	34	32	36	129	26	1,15
GH5	F32773	–	5,00	43	150	133	44	46	44	167	28	2,36
GH8	F32774	–	8,00	43	148	135	51	53	52	173	42	3,32
GH10	F32775	–	10,00	60	197	168	67	61	54	225	47	6,44

*W.L.L. values as per standard EN 1677-1. Test requirements according to test principle of excavator hooks for earthmoving equipments at lifting application (GS-MO 15-03) of the safety association.

The component must approve a strength introduction at the chosen place! Welding works are to be carried out in accordance with the delivered welding instructions! Please consider manuals on our website www.THIELE.de.

Spare Parts TWN 0913

for Weld-On Hook TWN 0850/2

Trade Size	Article-No.	Packaging Unit	Weight app. [kgs]	TWN 0913
GH 1, 2, 3	Z04496	1 set	0,06	
GH 5, 8	Z10614	1 set	0,20	
GH 10	Z05842	1 set	0,44	



Lifting Points, Weld-on Type

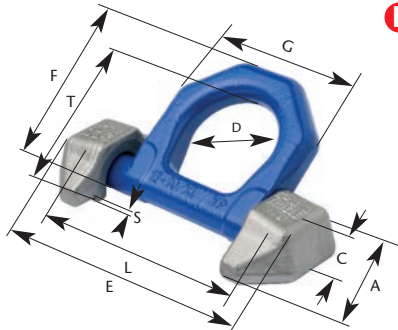

New Lifting Point with two Welding Brackets TWN 1872

The lifting points according to this TWN-works standard are designed for safe lifting, moving and securing of loads. The working load limits, production- and proof-requirements are based on the DIN EN 1677, part 1 and 4, taking a 25% higher working load limit into consideration.

The products comply with the EU-machine directive 2006/42/EG and have a CE-marking and traceability code.

The rings are marked with the working load limit (in t).

The safety factor is 1:4 related to the working load limit.

Finish: RAL 5002.



Trade Size	Article-No.	Article-No. (Ring only)	Working Load Limit [t max.]	Dimensions [mm]								Weight app. [kgs]	
				A	C	D	E	F	G	L	T		S
10-10	F352005	F352006	4,0	65	28	48	134	74	74	105	70	2	0,79
13-10	F352015	F352016	6,7	80	37	60	170	93	100	135	85	2	1,7

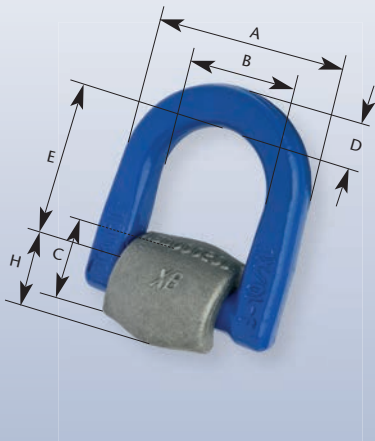

New Lifting Point „Compact“ with Spring TWN 1882

A perfect interplay of compactness and easy handling. The spring holds the D-link in its desired position. The small dimension, particularly the installation height of the TWN 1882 were the focus during the development process. A high working load limit and compact design makes our lifting point particularly remarkable.

The lifting point rotates 180° and is especially suitable for installation in skips.

Finish: RAL 5002.



Trade Size	Article-No.	Working Load Limit [t max.]	Dimensions [mm]						Weight app. [kgs]
			D	B	A	E*	H	C	
6-10	F352041	1,5	14	38	65	42	25	49	0,42
8-10	F352051	2,5	15	45	76	45	27	50	0,57
10-10	F352061	4,0	17	50	85	57	31	55	1,66
13-10	F352071	6,7	23	68	116	79	44	77	2,20
16-10	F352081	10,0	27	69	130	72	54	92	3,35

*Upright standing ring.



Lashing Points, Weld-on Type

Lashing Point with two Welding Brackets TWN 1473

The lashing points according to this TWN works standard are designed for load securing of goods. They comply with the requirements of the DIN EN 12640. The production- and proof-requirements are based on the DIN EN 1677, part 1 and 4, taking a 25% higher lashing capacity into consideration.

The rings are marked with the lashing capacity (in LC) and show a tracability code. The safety factor is 1:2 related to the lashing capacity.

Finish: RAL 5002.

New

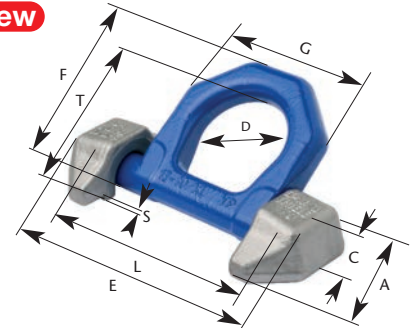

Lashing Capacity (LC) [daN]	Article-No.	Article-No. (Ring only)	Lashing Capacity (LC) [daN max.]	Dimensions [mm]										Weight app. [kgs]
				A	C	D	E	F	G	L	T	S		
10-10	F352001	F352002	8.000	65	28	48	134	74	74	105	70	2	0,79	
13-10	F352011	F352012	13.500	80	37	60	170	93	100	135	85	2	1,7	

Lashing Point „Compact“ with Spring TWN 1880

A perfect interplay of compactness and easy handling. The spring holds the D-link in its desired position. The small dimension of the TWN 1880 were the focus during the development process. A high lashing capacity and compact design makes our lashing point particularly remarkable.

The lashing point rotates 180° and is especially suitable for installation in skips.

Finish: RAL 5002.

New

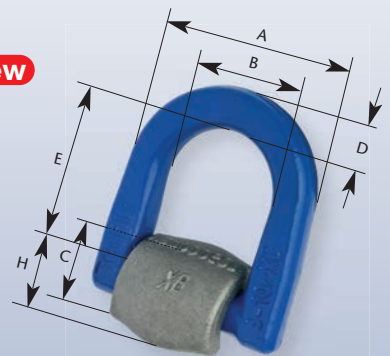

Trade Size	Article-No.	Lashing Capacity (LC) [daN max.]	Dimensions [mm]						Weight app. [kgs]
			D	B	A	E*	H	C	
6-10	F35204	3.000	14	38	65	42	25	49	0,42
8-10	F35205	5.000	15	45	76	45	27	50	0,57
10-10	F35206	8.000	17	50	85	57	31	55	1,66
13-10	F35207	13.500	23	68	116	79	44	77	2,20
16-10	F35208	20.000	27	69	130	72	54	92	3,35

*Upright standing ring.



Lashing Points

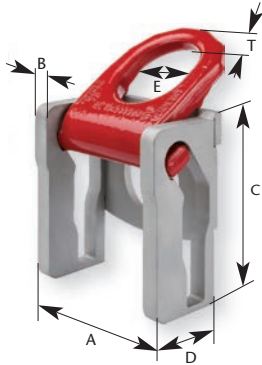

ZK-Module TWN 1471

The newly developed ZK-Module from THIELE is a lashing ring with cassette that can easily be adapted and attached to the side frames of trailers. These lashing rings are made of the same steel which is used in the manufacture of lashing chains.

The THIELE ZK-Module is approved by the German TÜV-inspection board and complies with the European standard DIN EN 12640.

It offers 100% lashing capacity and is capable of withstanding strain in all directions. The lashing point has a swivel range of 150°, enabling the secure lashing of low-load goods as well as goods that need protection beyond the load platform. Further on, the lashing ring is completely retractable, preventing accidents from happening when walking on the cargo area.

A new designed an patented slotted shape of the cassette enables a mechanical positioning of the lashing ring in pulling direction. Therefore the handling of lashing is considerably simplified for the operator.

Finish lashing ring: RAL 3003.

Legal protection of registered design: DE 20 2015 100 750.

Trade Size	Article-No.	Execution*	Lashing Capacity (LC) [daN max.]	Dimensions [mm]						Weight app. [kgs]
				A	B	C	D	E	T	
5	F352390	N	5.000	107	12	119	61	52	14	2,60
5 New	F352395	S	5.000	107	12	119	61	52	14	2,60
10	F352380	N	10.000	137	15	144	73	62	18	3,60
10 New	F352385	S	10.000	137	15	144	73	62	18	3,60

*The plates of the lashing cassette in the execution „N“ (=Normal) are produced in micro-alloyed steel. The execution „S“ (=Special) are produced from special steel and may be hot dip galvanized (up to 500°C), together with the vehicle frame.

The standard DIN EN 12640 specifies the minimum testing requirements for lashing points on road trucks and trailers with flat-bed bodies and a permissible total weight of more than 3,5 t that are meant for mixed cargo transportation. Lashing points are devices to which lashing devices may be directly fastened. A lashing point can be, for example, an oval link, hook, lug or lashing rail. This type of lashing points in practice are very often leading to problems.

A non-appropriate dimensioning and use of non-suitable lashing points, as well as the damage of the lashing point and frame of the vehicle, shows a high potential danger for traffic.

During application oval links are often exposed to unforeseen torque which may cause a damage to the body-work of the vehicle (see picture). Very often requested inclination angles are not properly considered. Further if not in use oval links can cause unnecessary noise exposure in traffic. The new developed THIELE ZK-Module (lashing ring with cassette) may be easily fitted and adopted at the side frame of the trailer.



Lashing Ring

The lashing ring is marked with permissible lashing capacity (LC), manufacturer name (THIELE) and DIN EN standard number (DIN EN 12640), so that official agencies are able to check its correct installation. The ZK-Module made by THIELE provides highest safety for load securing and in the heavy-duty road traffic.



Lashing Points

ZK-Module TWN 1471

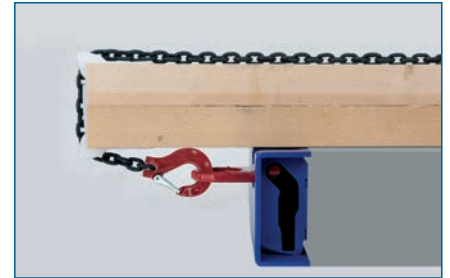
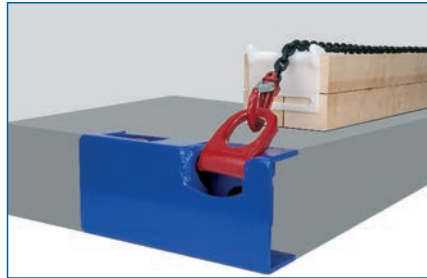

New

Now available with
mechanical positioning nose.

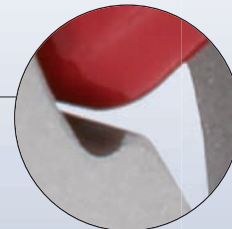



Operating Manual Lifting Points, Screwed Type TWN 0121, TWN 0122, TWN 0123, TWN 0127, TWN 1120, TWN 1830, TWN 1890

1 Description and Intended Use

THIELE lifting points screw-type are intended for attachment to steel, aluminum or non-ferrous metal structures and components.

Sling chains according to EN 818-4 or lashing chains according to EN 12195 may be used.

These Operating Instructions show the safety use of THIELE lifting points of the following executions:

- TWN 0121/1 Lifting points, rotatable, with slide bearing
- TWN 0122 Lifting points
- TWN 0123 Lifting points
- TWN 0127 Lifting points MDB
- TWN 1120 TITAN Lifting points, rotatable, with slide bearing
- TWN 1830 X-TREME Lifting points, rotatable, with ball bearing
- TWN 1890 Lifting points XS-Point, rotatable (TWN = THIELE workshop standard)

THIELE lifting points meet EG Machinery Directive 2006/42/EG requirements and feature a safety factor of at least 4 based on WLL.

THIELE lifting points are signed with the CE symbol. They are also signed with the Working Load Limit (WLL) in tons or the chain size, manufacturers mark (stamp 'H4') and identification number.

THIELE lifting points are designed to withstand 20,000 dynamic load changes under maximum load conditions. In the event of higher loads (e.g. multi-shift/automatic operation, magnetic spreaders) the WLL must be reduced. Lifting points must exclusively be used

- within the limits of their permissible working load limit,
- within the temperature limits prescribed,
- with suitable screws (see screw data) and fitted directly to the component.

The Working Load Limit of different modes of assembly can be seen in the load table.

THIELE lifting points are normally not intended for the transportation of persons.

Turning and rotating loads

- TWN 0121/1 Turning allowed, rotating not allowed.
- TWN 0122 Turning allowed, rotating not allowed.
- TWN 0123 No turning and/or rotating allowed.
- TWN 0127 Turning allowed, rotating not allowed.
- TWN 1120 Turning allowed, rotating not allowed.
- TWN 1830 Turning and rotating allowed.
- TWN 1890 Turning allowed, rotating not allowed.

This classification relates to occasionally turning or rotating loads.

Continuous or long-term turning or rotating is not allowed.

Using the lifting points exclusively for lashing the maximum lashing capacity is calculated by doubling the Working Load Limit.

An alternating use for lifting and lashing is not allowed.

2 Safety Notes

Risk of Injury!

Never walk or stay under lifted loads!

Make sure to use hoisting /attachment means free from defects.

- Operators, fitters, and maintenance personnel must in particular observe the Operating Instructions also from the used sling chain assemblies,

documentations DGUV V 1, DGUV R 100-500 Chapter 2.8 and DGUV I 209-013 issued by the German Employers' Liability Insurance Association, as well as the Operating Instructions of the loads concerning advise for lifting.

- In the Federal Republic of Germany, the Operational Safety Ordinance (BetrSichV) has to be implemented and the Technical Rule for Industrial Safety TRBS 1201, in particular Annex 1, Chapter 2 "Special regulations for the use of working equipment for lifting loads" must be observed.
- Outside the Federal Republic of Germany the specific provisions issued locally in the country where the items are used must also be observed.
- The directions given in these Operating Instructions and specified documentations relating to safety, assembly, operation, inspection, and maintenance must be made available to the respective persons.
- Make sure these Operating Instructions are available in a place near the product during the time the equipment is used.

Please contact the manufacturer if replacements are needed.

- **When performing work make sure to wear your personal protective equipment!**
- **Improper assembly and use may cause personal injury and/or damage to property.**
- Assembly and removal as well as inspection and maintenance must exclusively be carried out by skilled and authorized persons.
- Structural changes are impermissible (e.g. welding, bending).
- **Operators must carry out a visual inspection and, if necessary, a functional test of the safety equipment before each use.**

- Never put to use worn-out, bent or damaged lifting points.
- Only lift loads the mass of which is less than or equal to the working load limit of the lifting points.
- Do not use force when mounting/positioning the lifting points.
- Only lift loads that are freely movable and not attached or fastened.
- Do not bend the ring or suspension link.
- Do not start lifting before you have made sure the load has been correctly attached.
- Make sure no one including you (operator) is in the way of the moving load (hazard area).
- During lifting/hoisting make sure your hands or other body parts do not come into contact with hoisting means. Only remove hoisting means manually (use your hands).
- Avoid impacts, e.g. due to abruptly lifting loads with chain in slack condition.
- Never move a suspended load over persons.
- Never cause suspended loads to swing.
- Always monitor a suspended load.
- Put the load only down in places/sites where it can be safely deposited.
- Put the load only down in flat places/sites where it can be safely deposited.
- Take care for sufficient place for the personnel to move when choosing the route of transportation and storage location. Danger to life and risk of injury by crushing hazards!
- In the event of doubts about the use, inspection, maintenance or similar things contact your safety officer or the manufacturer!

THIELE will not be responsible for damage caused through non-observance of the instructions, rules, standards and notes indicated!

As regards quality grade 10/XL THIELE does not give its general approval to the assembly of components stemming from different manufacturers!

Working under the influence of drugs or alcohol is strictly forbidden!

3 Commissioning

Prior to using the components for the first time make sure that

- the lifting points comply with the order and have not been damaged,
- test certificate, statement of compliance, and operating instructions are at hand,
- markings correspond with what is specified in the documentation,
- inspection deadlines and the qualified persons for examinations are determined,
- visibility and functional testing are carried out and documented,
- documentations are safely kept in an orderly manner. Dispose of the packing in an environmentally compatible way according to local rules.

5 Assembly and Removal

5.1 Preparations

The mounting location for each lifting point has to ensure that

- the load can take the forces safely to be applied without suffering deformation,
- the lifting point can be assembled flush,
- no areas of danger are created (crushing point, shearing point),
- transportation is not restrained by overhang,
- incorrect use is avoided,
- the suspension gear cannot be damaged, for example by sharp edges,
- the lifting point can be used easily.

5.2 Assembly

The useful depth of the thread must enable the lifting points to be safely screwed in. Use only the delivered screws!

Make sure the tapped hole is arranged at right angle to the attachment face on the component. The depth of the thread „L“ of the component must at least be as follows:

$L = 1 \times d$ for steel

$L = 2 \times d$ for aluminum

$L = 1,25 \times d$ for castings

$L = 2,5 \times d$ in aluminum-magnesium-alloys

(L = depth of thread; d = thread diameter)

- Make sure the threads of the lifting point and in the component are clean and dry.
- For lifting points have to remain on the component a usual fluid safety agent for screws has to be used.
- In case of straight fittings the nut has to be secured against unintentionally loosening.
- TWN 0123, TWN 1120 and TWN 1830: Use a suitable open-ended spanner or ring spanner to fix the lifting points so as to be finger-tight.

- TWN 0121/1, TWN 0122, TWN 0127 and TWN 1890:

Take care to tighten the screws by the right torque shown in the table. As long as it is ensured there is no load turning for a singular use and the lifting point cannot be loosened a hand tightening of the lifting points by a suitable open-ended spanner or ring spanner is sufficient. **An additional check is necessary in case of a repeated load lowering.**

- TWN 1830: Take care not to exceed the tightening torque of 40 Nm for screws M10 and M12.





There has to be made a chamfer on the hole for the thread:

Thread M10 and M12:	Chamfer 2,0+0,5 x 45°
Thread M16 and M20:	Chamfer 2,5+0,5 x 45°
Thread M24 and M30:	Chamfer 3,5+0,5 x 45°
Thread M36 and M42:	Chamfer 4,0+0,5 x 45°
Thread M48 and M64:	Chamfer 4,5+0,5 x 45°

6 Conditions of Use

6.1 Normal Use

The top part of the lifting point including attachment link must always be freely movable.

It must not rest on or be supported by other structural parts.

When attaching the components make sure the position of the lifting point always enables forces to be exerted in longitudinal direction of the suspension link.

Make sure only the top parts of the lifting points turns into loading direction and not the firmly secured stationary portion.

Using 4-leg chain link assemblies may cause higher risk because only 2 opposite legs carrying the load. Check the Working Load Limit of lifting point and chain link assembly carefully and chose if necessary bigger sizes.

The force must be applied lengthwise to the suspension link.

TWN 1830:



The lifting point must not be used for a permanent or prolonged turning of the load.

TWN 1890:



6.2 Influence of Temperature

The permissible Working Load Limit of the lifting points reduces at elevated temperatures.

The reduced Working Load Limit figures shown in the following tables shall only apply for short-term use at the temperatures indicated.

If the lifting points have been exposed to temperatures exceeding the maximum values specified they must no longer be used.

TWN 0121/1, TWN 0122, TWN 0127, TWN 1120, TWN 1890:

Temperature range	Remaining Working Load Limit
-20 °C ≤ t ≤ 100 °C	100 %
100 °C < t ≤ 200 °C	85 %
200 °C < t ≤ 250 °C	80 %
250 °C < t ≤ 300 °C	75 %

TWN 0123, TWN 1830:

Temperature range	Remaining Working Load Limit
-30 °C ≤ t ≤ 200 °C	100 %
200 °C < t ≤ 300 °C	90 %
300 °C < t ≤ 400 °C	75 %

TWN 1830:

Take care for a loss of lubricant depending on several fitting positions and higher temperatures. A higher wear may occur.

Shorten the inspection interval for that case.

6.3 Environmental Influence

Lifting points must not be used in environments where acids, aggressive or corrosive chemicals or their fumes are present.

Hot-dip galvanizing or a galvanic treatment is prohibited as well.

7 Inspections, Maintenance, Disposal

Inspections and maintenance must be arranged for by the Owner!

Inspection deadlines shall be determined by the Owner!

Inspections must be carried out and documented by competent persons regularly but at least once a year, or more frequently if the lifting points are in heavy-duty service. After three years at the latest they must additionally be examined for cracks. A load test shall never be considered a substitute for this examination.

The results of the inspection shall be entered into a register (DGUV I 209-062 or DGUV I 209-063) to be prepared when the lifting point is firstly used. The register will show characteristic data of the lifting points and other components as well as identity details.

Immediately stop using lifting points that show the following defects:

- missing or illegible identification/markings,
- deformation, elongation or fractures,
- cuts, notches, cracks, incipient cracks, pinching,
- no freely rotating or turning possible,
- heating beyond permissible limits,
- severe corrosion,
- wear exceeding 10 %, for example in the suspension link diameter area,
- defect screws,
- TWN 1830: gap size „s“ exceeds figures in table below.

Max. gap size „s“ for TWN 1830:

Thread	s [mm]
M10 – M20	1,5
M24	2,0
M30	2,5
M36	3,0
M42 – M64	3,5

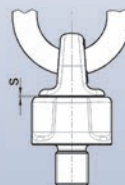

Inspection Service

THIELE offers inspection, maintenance and repair services for lifting points performed by trained and competent personnel.

Maintenance

Maintenance and repair work must only be performed by competent persons.

Minor notches and cracks at suspension links may be eliminated by careful grinding observing the maximum cross section reduction requirement of 10 % and avoid making more severe cuts or scores.

All maintenance and repair activities are to be documented.

Disposal

All components and accessories of steel taken out of service are to be scrapped in line with local regulations and provisions.

8 Spare parts

Only use original THIELE-spare parts. Exclusively use original THIELE screws and bolts because these are made to meet special requirements.

Screws	WLL	Article-no.	Screw datas
TWN 0127	3,15	Z07742	M20 x 50 ISO 4017 10.9
		5,3	Z09017 M24 x 50 ISO 4017 10.9
TWN 1890	0,63	Z10836	M10 x 45 ISO 4017 12.9
	1,0	Z10795	M12 x 50 ISO 4017 12.9
	1,7	Z09544	M16 x 70 ISO 4017 10.9
	2,5	Z08692	M20 x 80 ISO 4017 10.9
	4,0	Z09809	M24 x 90 ISO 4017 12.9
	6,0	Z07810	M30 x 100 ISO 4017 12.9
	8,0	Z07828	M36 x 120 ISO 4017 12.9
	10	Z10136	M42 x 140 ISO 4017 10.9

9 Use of different fasteners

If local circumstances dictate that different screws and bolts have to be used from those supplied with the installation, or listed in Section 8, the operator must ensure that

- these fasteners conform to the specified diameter and strength class,
- they can achieve the minimum required screw-in depth,
- they are 100% crack tested,
- each bolt has a proven notch impact energy of min. 36 J as a mean value of three samples tested at -20 °C or at the lowest fitting temperature, if this is below -20 °C, and that none of the samples falls below 25 J,
- written confirmation of the crack test and impact energy results is enclosed with the technical documentation.

10 Storage

Lifting points are stored in dry locations at temperatures ranging between 0 °C and +40 °C.

11 THIELE Operating and Mounting Instructions

Current operating and installation instructions are available as a PDF download on the homepage.

12 Publishing Information

THIELE GmbH & Co. KG,
Werkstraße 3, 58640 Iserlohn, Germany
Tel.: +49(0)2371/947-0 // Email: info@thiele.de

© THIELE GmbH & Co. KG, 2018.
All rights reserved.





Operating Manual Lifting Points, Weld-on Type TWN 0119, TWN 0124 with Spring, TWN 1880

1 Description and Intended Use

THIELE Lifting Points weld-type are intended for attachment to steel structures and components. Sling chains according to EN 818-4 or lashing chains according to EN 12195 may be used. Weld-type Lifting Points mainly consist of a forged weld-on support and a welded or forged ring. For Lifting Points of TWN 0124 and TWN 1882 springs are integrated to the weld-on support to provide position stabilization and noise reduction when not in use. (TWN = THIELE standard)

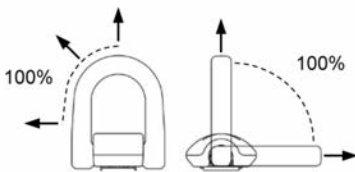

Lifting Points can be loaded to 100 % in all tensile directions.

THIELE Lifting Points meet EG Machinery Directive 2006/42/EG requirements and feature a safety factor of at least 4 based on Working Load Limit (WLL). THIELE Lifting Points are signed with the CE symbol.

They are also signed with the Working Load Limit in tons or the chain size, manufacturers mark (stamp 'H4') and traceability code #.

THIELE Lifting Points are designed to withstand 20,000 dynamic load changes under maximum load conditions. In the event of higher loads (e.g. multi-shift/automatic operation) the Working Load Limit must be reduced.

Lifting Points must exclusively be used

- within the limits of their permissible working load limit,
- for permissible attachment modes and inclination angles,
- within the temperature limits prescribed,
- with properly laid welding seams.

Working Load Limit of different modes of assembly can be seen in the load table.

Using the Lifting Points of TWN 0119 and TWN 0124 exclusively for lashing the maximum Lashing Capacity (LC) is calculated by doubling the Working Load Limit.

An alternating use for lifting and lashing is not allowed.

TWN 1882:

There are identically constructed Lashing Points by TWN 1880 available.

2 Safety Notes

Risk of Injury!
Never walk or stay under lifted loads!
Make sure to use hoisting/attachment means free from defects.

- Operators, fitters, and maintenance personnel must in particular observe the Operating Instructions also from the used sling chain assemblies, documentations DGUV V 1, DGUV R 100-500 Chapter 2.8 and DGUV I 209-013 issued by the German Employers' Liability Insurance Association, as well as the Operating Instructions of the loads

concerning advise for lifting.

- In the Federal Republic of Germany, the Operational Safety Ordinance (BetrSichV) has to be implemented and the Technical Rule for Industrial Safety TRBS 1201, in particular Annex 1, Chapter 2 "Special regulations for the use of working equipment for lifting loads" must be observed.
- Outside the Federal Republic of Germany the specific provisions issued locally in the country where the items are used must also be observed.
- The directions given in these Operating Instructions and specified documentations relating to safety, assembly, operation, inspection, and maintenance must be made available to the respective persons.
- Make sure these Operating Instructions are available in a place near the product during the time the equipment is used. Please contact the manufacturer if replacements are needed. See also chapter 9.
- **When performing work make sure to wear your personal protective equipment!**
- **Improper assembly and use may cause personal injury and/or damage to property.**
- Assembly and removal as well as inspection and maintenance must exclusively be carried out by skilled and authorized persons.
- Structural changes are impermissible (e.g. welding, bending).
- **Operators must carry out a visual inspection and, if necessary, a functional test of the safety equipment before each use.**
- Never put to use worn-out, bent or damaged Lifting Points.
- Only lift loads the mass of which is less than or equal to the Working Load Limit of the Lifting Points.
- Do not use force when mounting/positioning the Lifting Points.
- Only lift loads that are freely movable and not attached or fastened.
- Do not bend the ring.
- Do not start lifting before you have made sure the load has been correctly attached.
- Make sure no one including you (operator) is in the way of the moving load (hazard area).
- During lifting/hoisting make sure your hands or other body parts do not come into contact with hoisting means. Only remove hoisting means manually (use your hands).
- Avoid impacts, e.g. due to abruptly lifting loads with chain in slack condition.
- Never move a suspended load over persons.
- Never cause suspended loads to swing.
- Always monitor a suspended load.
- Put the load only down in places/sites where it can be safely deposited.
- In the event of doubts about the use, inspection, maintenance or similar things contact your safety officer or the manufacturer!

THIELE will not be responsible for damage caused through non-observance of the instructions, rules, standards and notes indicated!
As regards quality grade 10/XL THIELE does not give its general approval to the assembly of components stemming from different manufacturers!
As a rule, shortening claws are not permitted for the transportation of persons.
Working under the influence of drugs or alcohol is strictly forbidden!

3 Commissioning

Prior to using the components for the first time make sure that

- the Lifting Points comply with the order and have not been damaged,
- test certificate, statement of compliance and Operating Instructions are at hand,
- markings correspond with what is specified in the documentation,
- inspection deadlines and the qualified persons for examinations are determined,
- visibility and functional testing are carried out and documented,
- the documentation is safely kept in an orderly manner.

Dispose of the packing in an environmentally compatible way according to local rules.

5 Assembly and Removal

5.1 Preparations

The mounting location for each Lifting Point has to ensure that

- the load can take the forces including test loads safely to be applied without suffering deformation,
- no areas of danger are created (crushing point, shearing point),
- transportation is not restrained by overhang,
- lifting accessories will not be bypassed,
- incorrect use is avoided,
- the suspension gear cannot be damaged, for example by sharp edges,
- the Lifting Point can be used easily.

Make sure the welding surfaces are grinded down, flat, dry, free of impurity, flawless and weldable (material see ISO/TR 15608 table 1, group 1). Make sure the weld area at the component is able to absorb the input force without safety reducing deformation.

Make sure the weld seam area at the component is large enough for the Lifting Points to be safely attached by welding.

5.2 Welding Instructions

Welding Instructions relating to weld-on supports (S355NL or similar) to be attached to C22, S235, S355 or similar components.

The following general Welding Instructions shall be duly followed:

Personell, Quality	DIN EN ISO 3834
	DIN EN ISO 14731
	DIN EN ISO 9606
Welding process	DIN EN 1011
	DIN EN 1090
	DIN EN 15085
	DIN 15018
Further	ISO/TR 15608
	SEW 088

Do not weld on the movable rings!

Take care not to widen the gap for the root run during tack-welding.
 Take care for an accurate cleaning of the root run.
 Take care to avoid end crater.
 Continue the welding within one heat.

Sketch:



Miscellaneous:

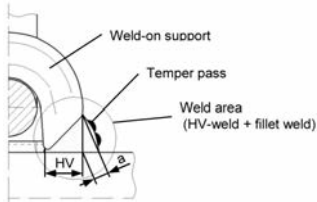

1. Minimum notched-bar impact strength values of ISO-V specimens KV=27J at -40 °C (e.g. S355J4G3 or S355NL, EN10025)
2. When selecting material grades other than those listed above please contact the base material and filler metal manufacturers for information.
3. The responsible welding supervisor must make sure the welding current is correctly adjusted to suit the given welding position.

6 Conditions of Use

6.1 Normal Use

The ring of the Lifting Point must always be freely movable.

It must not rest on or be supported by other structural parts.

Using 4-leg chain link assemblies may cause higher risk because only 2 opposite legs carrying the load. Check the Working Load Limit of Lifting Points and chain link assembly carefully and chose if necessary bigger sizes.

6.2 Influence of Temperature

The permissible Working Load Limit of the Lifting Points reduces at elevated temperatures.

The reduced Working Load Limit shown in the following tables shall only apply for short-term use at the temperatures indicated.

If the Lifting Points have been exposed to temperatures exceeding the maximum values specified they must no longer be used.

Type	Temperature range	Remaining Working Load Limit
TWN 0119/		
TWN 0124	-40 °C ≤ 200 °C	100 %
	200 °C ≤ 300 °C	90 %
	300 °C ≤ 400 °C	75 %
TWN 1882	-30 °C ≤ 200 °C	100 %
	200 °C ≤ 300 °C	90 %
	300 °C ≤ 380 °C	60 %

6.3 Environmental Influence

Lifting points must not be used in environments where acids, aggressive or corrosive chemicals or their fumes are present.

Hot-dip galvanizing or a galvanic treatment is prohibited as well.

7 Inspections, Maintenance, Disposal

Inspections and maintenance must be arranged for by the Owner!

Inspection deadlines shall be determined by the Owner!

Inspections must be carried out and documented by competent persons regularly but at least once a year, or more frequently if the Lifting Points are in heavy-duty service. After three years at the latest they must additionally be examined for cracks. A load test shall never be considered a substitute for this examination.

The results of the inspection shall be entered into a register (DGUV I 209-062 or DGUV I 209-063) to be prepared at first use. The register will show characteristic data as well as identity details.

Immediately stop using Lifting Points that show the following defects:

- missing or illegible identification/markings,
- deformation, elongation or fractures,
- cuts, notches, cracks, incipient cracks, pinching,
- heating beyond permissible limits,
- severe corrosion,
- wear exceeding 10 %, for example in the ring diameter area,
- weld failures.

Inspection Service

THIELE offers inspection, maintenance and repair services by trained and competent personnel.

Maintenance

Maintenance and repair work must only be performed by competent persons.

Minor notches and cracks at the rings may be eliminated by careful grinding observing the maximum cross section reduction requirement of 10 % and avoid making more severe cuts or scores.

All maintenance and repair activities are to be documented.

Disposal

All components and accessories of steel taken out of service are to be scrapped in line with local regulations and provisions.

8 Storage

Lifting Points are stored in dry locations at temperatures ranging between 0 °C and +40 °C.

9 THIELE Operating and Mounting Instructions

Current operating and installation instructions are available as a PDF download on the homepage.

10 Publishing Information

THIELE GmbH & Co. KG,
Werkstraße 3, 58640 Iserlohn, Germany
Tel.: +49(0)2371/947-0 // Email: info@thiele.de

© THIELE GmbH & Co. KG, 2018.
All rights reserved.





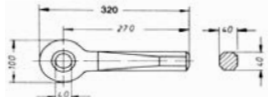

Hitches

Article-No.	Type	Bush [mm]	Bore [mm]	Weight app. [kgs]	TWN 0301
F27100	C	-	40	3,7	
F27101	A	40	48	3,7	
					

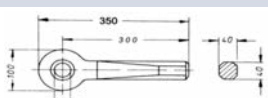
Hitches acc. to
DIN 74054 Part 1 and Part 2

Article-No.	Type	Bush [mm]	Bore [mm]	Weight app. [kgs]	TWN 0302
F27110	C	-	40	4,0	
F27111	A	40	48	4,0	
					

Hitches acc. to
DIN 74054 Part 1 and Part 2

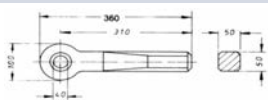
Article-No.	Type	Bush [mm]	Bore [mm]	Weight app. [kgs]	TWN 0304
F27130	C	-	40	5,1	
F27131	A	40	48	5,1	
					

Hitches acc. to
DIN 74054 Part 1 and Part 2



THIELE Hoist Chains



Fine Tolerance Hoist Chains



THIELE hoist chains according to EN 818-7 are manufactured on modern digital controlled production lines. The high dimension accuracy enables high performance hoists a faultless run of the chain over the sprocket. The heat treatment is being done in modern and environmental friendly continuous heat treatment facilities. Therefore, THIELE hoist chains have a homogenous high tensile strength with an exceeding core ductility along the legs and rounding of each link.

Hoist chains are basically designed for the following applications:

Type T:

- + for manual chain hoists
- + for motor-driven, low-speed hoists
- + no significant abrasion from the working environment

Type DAT:

- + motor-driven, high-speed hoists with a high load capacity
- + high wear resistance over longer operating periods

Type DT:

- + motor-driven hoists
- + abrasive working environment

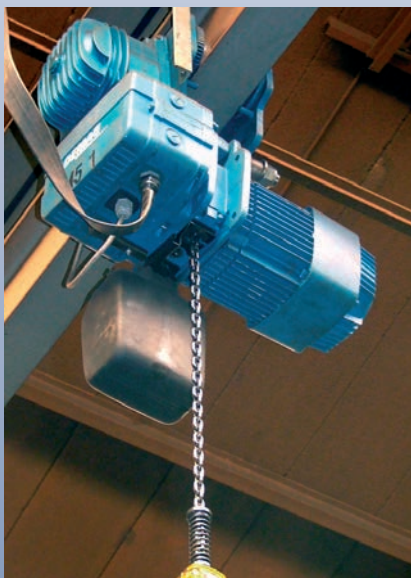

Notice:

Case-hardened chains are not suitable for use in portable, hand-operated hoists.

Fine Tolerance Hoist Chains

Dimensions

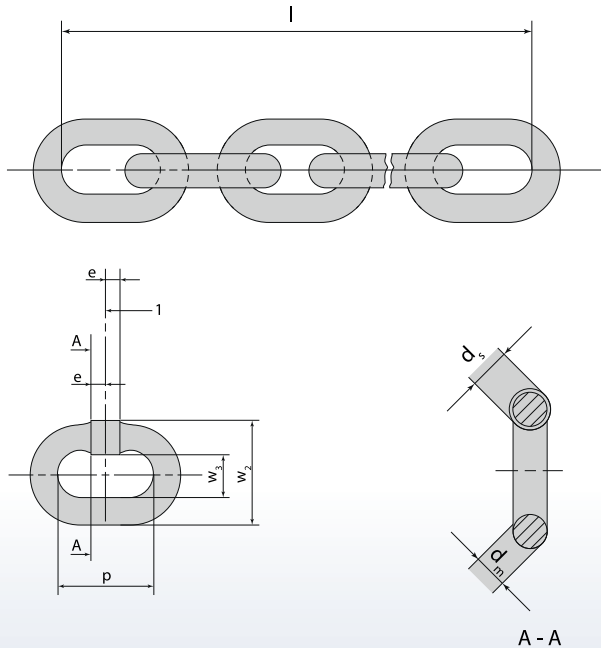

Key

- 1 intersection
- l* multi pitch length
- p* pitch
- d_m material diameter
- d_w weld-point diameter
- e* length of weld-point section
- w_3 internal width of weld point
- w_2 external width over weld point



Size Table

Dimension [mm]	Nominal Size		Pitch		Width		Multi Pitch Length	
	d [mm]	tol. ± [mm]	p [mm]	tol. ± [mm]	w ₃ [mm min.]	w ₂ [mm max.]	11 x p [mm]	tol. ± [mm]
4 x 12	4,0	+0,20 / -0,20	12,0	+0,15 / -0,10	4,8	13,6	132,0	+0,40 / -0,20
4,2 x 12,2	4,2	+0,10 / -0,20	12,2	+0,15 / -0,10	4,8	13,7	134,2	+0,40 / -0,20
5 x 15	5,0	+0,20 / -0,20	15,0	+0,20 / -0,10	6,0	17,0	165,0	+0,50 / -0,30
5,3 x 15,2	5,3	+0,10 / -0,20	15,2	+0,20 / -0,10	5,9	16,9	167,2	+0,50 / -0,30
6 x 18	6,0	+0,20 / -0,20	18,0	+0,25 / -0,10	7,2	20,4	198,0	+0,60 / -0,30
7 x 21 ¹⁾	7,0	+0,10 / -0,28	21,0	+0,30 / -0,00	8,4	23,4	231,0	+0,70 / -0,00
7 x 22	7,0	+0,30 / -0,30	22,0	+0,30 / -0,15	8,4	23,8	242,0	+0,80 / -0,40
7,4 x 21,2	7,4	+0,10 / -0,30	21,2	+0,30 / -0,15	8,4	23,8	233,2	+1,70 / +0,70
8 x 24	8,0	+0,30 / -0,30	24,0	+0,30 / -0,15	10,2	27,2	264,0	+0,80 / -0,40
9 x 27 ¹⁾	9,0	+0,10 / -0,40	27,0	+0,25 / -0,10	10,8	30,4	297,0	+0,70 / -0,30
10 x 30	10,0	+0,40 / -0,40	30,0	+0,40 / -0,20	12,0	34,0	330,0	+1,00 / -0,50
11 x 31 ¹⁾	11,0	+0,30 / -0,40	31,0	+0,30 / -0,15	13,2	36,5	341,0	+0,90 / -0,30
13 x 36 ¹⁾	13,0	+0,10 / -0,50	36,0	+0,35 / -0,15	15,2	42,9	396,0	+1,10 / -0,20
16 x 45 ¹⁾	16,0	+0,30 / -0,60	45,0	+0,45 / -0,25	18,2	52,8	495,0	+1,40 / -0,50
18 x 50	18,0	+0,90 / -0,90	50,0	+0,65 / -0,35	21,6	61,2	550,0	+1,75 / -0,85
22 x 66 ¹⁾	22,0	+0,80 / -1,10	66,0	+0,65 / -0,35	27,0	75,0	726,0	+2,00 / -0,70
31,5 x 90 ¹⁾²⁾	31,5	+1,60 / -1,60	90,0	+1,20 / -0,60	37,8	107,1	990,0	+3,20 / -1,60

¹⁾Limited tolerances. Also complies with RAG 726 300.

²⁾Similar to EN 818-7.



Fine Tolerance Hoist Chains

Working Load Limits

Nominal Diameter d_n [mm]	Type T [t max.]	Type DAT [t max.]	Type DT [t max.]
4	0,5	0,4	0,25
5	0,8	0,6	0,4
6	1,1	0,9	0,56
7	1,5	1,2	0,75
8	2,0	1,6	1,0
9	2,5	2,0	1,25
10	3,2	2,5	1,6
11	3,8	3,0	1,9
12	4,5	3,6	2,2
13	5,3	4,2	2,6
14	6,0	5,0	3,0
16	8,0	6,3	4,0
18	10,0	8,0	5,0
20	12,5	10,0	6,3
22	15,0	12,5	7,5

Nominal Stress

Type T [N/mm ² min.]	Type DAT [N/mm ² min.]	Type DT [N/mm ² min.]
200*	160	100

*Only for hand-operated hoists. For motor-driven hoists see DIN EN 818-7.

Mechanical Properties

Nominal Size d_n [mm]	Test Force (MPF) [kN min.]	Breaking Force (BF) [kN min.]
4	12,6	20,1
5	19,6	31,4
6	28,3	45,2
7	38,5	61,2
8	50,3	80,4
9	63,6	102,0
10	78,5	126,0
11	95,0	152,0
12	113,0	181,0
13	133,0	212,0
14	154,0	246,0
16	201,0	322,0
18	254,0	407,0
20	314,0	503,0
22	380,0	608,0

Fine Tolerance Hoist Chains

Elongation and Deflection

Type	Properties	Elongation at Break A [% min.]	Deflection f [mm min.]
T		10	$0,8 d_n$
DAT		10	b
DT		5	b

Surface Hardness

Type	Surface Hardness ¹⁾	$d_n < 7$ mm [HV5 min.]	$d_n = 7-11$ mm [HV10 min.]	$d_n > 11$ mm [HV10 min.]
T		360	360	360
DAT		500	500	450
DT		550	550	500

¹⁾At defined measuring points acc. to EN 818-7.

Hardening Depth

Nominal Size d_n [mm]	Type	
	DAT [mm]	DT [mm]
< 8	$(0,04 \pm 0,01) d_n$	$(0,05 \pm 0,01) d_n$
≥ 8	$(0,03 \pm 0,01) d_n$	$(0,04 \pm 0,01) d_n$

Chemical Composition

The steel must contain nickel and at least one of the other alloying elements with the minimum contents indicated in the following table:

Grade	Mass content according to cast analysis		
	Type T [% min.]	Type DAT [% min.]	Type DT [% min.]
Nickel	0,40	0,70	$0,90^{2)}$
Chromium	0,40	0,40	0,40
Molybdenum	0,15	0,15	0,15

²⁾A higher surface hardness and/or a greater hardening depth requires a higher nickel content in order to prevent embrittlement.

Fatigue Strength

Hoist chains of type DAT and DT must be capable of withstanding at least 2×10^6 cycles in the following stress range without failure.

Upper Stress (σ) [N/mm ² max.]	Medium Stress (σ) [N/mm ²]	Lower Stress (σ) [N/mm ² min.]
200	120	120



Fine Tolerance Hoist Chains

Operating Temperatures

THIELE hoist chains of type T and DAT can be used at operating temperatures of up to 200°C. They must not be used at temperatures above 200°C.

Type	Lowest Temperature	
	[°C max.]	
T	-40	
DAT	-20	
DT	-10	

Surface

THIELE-hoist chains are produced as standard in either bright or galvanised finish. Other surface treatments, such as zinc-flake coating and thick-film passivation, are available on request. THIELE galvanising is carried out using the drum method. Because of its process characteristics this technique provides a more uniform corrosion protection for the hoist chain than the continuous galvanisation method. After galvanising THIELE hoist chains are tested with a manufacturers proof force. This is designed to exclude any chains showing signs of material embrittlement.

Marking

The marking relates to the specifications of EN 818-1.

The quality marking for the hoist chain is 'T', 'DAT' or 'DT', according to type.

Test Certificates

If a hoist chain is being supplied in meters it must bear the appropriate CE-marking in accordance with the EU-machinery directive. It must also be accompanied by the required supporting documents, including a declaration of conformity operating instructions can be downloaded on www.thiele.de. The test certificate must meet the requirements of EN 818-1.

ISO-Mechanism Groups

Chain Type	Mechanism groups (according to ISO 4301)													
	M ₂		M ₃		M ₄		M ₅		M ₆		M ₇		M ₈	
	T&DAT	DT	T&DAT	DT	T&DAT	DT	T&DAT	DT	T&DAT	DT	T&DAT	DT	T&DAT	DT
Nominal stress (σ_B) at minimum breaking strength (BF_{min})	800		800		800		800		800		800		800	
Nominal stress at production test force (MPF)	500		500		500		500		500		500		500	
Nominal stress (σ_{Lim}) at dynamic limit load (F_{Lim})	225	200	200		180		160		140		125		112	
Nominal stress (σ_{CF}) at maximum permissible chain force (F_{CF})	160	100	160	100	140	90	125	80	112	70	100	63	90	56

Note: The stress figures in this table are obtained by dividing the force by the entire cross section of both legs of the link, i.e. these are nominal stresses. The stresses are not uniformly distributed; the local tensile stress is much greater, especially at the outer faces of the link.

Recommendation: In order to guarantee optimised frictionless operation run between the sprocket and hoist chain, please send us your hoist sprocket.



Fine Tolerance Hoist Chains

Instructions for the Correct Use of Hoist Chains

1. Select the right size and finish of the chain under consideration of the selection criteria acc. to EN 818-7.
2. Pay attention to correct attachment of the chains in the hoist.

The hoist chain must be properly guided and should enter and leave the pocket wheels without twisting.

In order to ensure that the hoist chain runs smoothly over the pocket wheels without any unusual shocks, the drive wheels and tail wheels must match the type of chain used.

The connector element for the hoist in the last link of the chain strand should not widen the profile of the link at this point and there must be a clearance of at least 5% available at the inner width of the hoist chain.

3. Cleaning and lubricating

Hoist chains must be properly and continuously lubricated, especially in the joint areas, in order to ensure a long service life.

The hoist chain must not be exposed to any kind of contamination that could affect its freedom of movement.

4. Hoist chains are not allowed to be used as lifting chains. Equally, a hoist chain fitted to a hoist must not be used for bridle hitch or choke hitch slinging.



Discard Criteria

Chain hoists should be immediately withdrawn from service if the chain exhibits any of the following defects:

- + deformation/stretch (even if this only affects individual chain links)
- + cut notches, cracks, incipient cracks, pinching
- + exposure to heat above the permitted range
- + severe corrosion
- + wear in excess of 10% (e.g. of averaged thickness of chain link)
- + increase of more than 5% in the pitch of individual links
- + increase in pitch, measured over 11 links, of more than 2% in the case of motor-driven hoists and 3% in the case of hand-operated hoists
- + illegible markings.



Fine Tolerance Hoist Chains

Article Numbers

Calibrated Hoist Chains

Dimension [mm]	Article-No. Type T		Article-No. Type DAT		Weight app. [kgs/m]
	bright	el. galvanized	bright	el. galvanized	
4 x 12	–	–	–	F09008	0,35
4,2 x 12,2	–	–	–	–	0,39
5 x 15	–	F09016	–	F09018	0,55
5,3 x 15,2	–	–	–	–	0,63
6 x 18	–	F09026	–	F09028	0,79
7 x 21 ¹⁾	F09030	F09031	–	F09033	1,08
7 x 22	–	F09036	–	F09038	1,06
7,4 x 21,2	–	–	–	–	1,23
8 x 24	–	F09046	–	F09048	1,41
9 x 27 ¹⁾	F09050	F09051	–	F09053	1,79
10 x 30	–	F09056	–	F09058	2,21
11 x 31 ¹⁾	F09060	F09061	–	F09063	2,75
13 x 36 ¹⁾	F09065	F09066	–	–	3,87
16 x 45 ¹⁾	F09070	F09071	–	–	5,82
18 x 50	F09075	F09076	–	–	7,40
22 x 66 ¹⁾	F09080	F09081	–	–	10,70
31,5 x 90 ¹⁾²⁾	F09085	F09086	–	–	22,40

¹⁾Limited tolerances. Also complies with RAG 726 300.

²⁾Similar to EN 818-7.

Calibrated Hand Chain

Dimension [mm]	Article-No.	Weight app. [kgs/m]
5 x 25	Z02655*	0,46

*Execution: Electro galvanized.

Advantages at a glance:

- ⊕ Fine toleranced dimensions
- ⊕ Homogen tensile strengths
- ⊕ Excellent core ductility
- ⊕ High safety against hydrogen embrittlement (electro galvanized chains)
- ⊕ High wear resistant



Fine Tolerance Hoist Chains

Maintenance and Handling of Hoist Chains

Maintenance:

Hoist chains are subject to significant interlink wear due to the deflection on the drive wheel and, possibly, also on the tail wheels (e.g., bottom block).

Further wear is due to the frictional contact of the chain link arm on the wheel pockets or even the guide elements.

To keep this wear to a minimum, a hoist chain should be fully lubricated, if possible, as part of the initial startup.

The lubricating film on the hoist chain left from manufacturing processes or warehousing is not sufficient.

When lubricating, make sure the lubricant also reaches the inner sides of each rounded area on every link. This increases the service life considerably.

If the chain is dirty and unlubricated, this can cause premature wear and subsequent chain failure.

Unless specified otherwise by the chain hoist manufacturer, lubricate the chain, for example, with a mineral oil according to DIN 51502 CLP 220 or, in case of a dusty or dirty environment, with a dry-film lubricant such as UNIMOLY C 220 Spray.

Exceptions:

In rare cases, chain hoists are used in very dusty environments with abrasive media, which means the dust sticks to the chains because of the lubricant and thus contributes to wear instead of preventing it. Here, the use of DAT hoist chains (deeper case depth) without lubrication is recommended.

Hoists are used in food production as well. This requires the use of stainless steel chains and / or food grade lubricant depending on the application.

Inspections:

The respective, valid regulations DGUV-54 as well as the stipulations of DIN 685-5, DIN EN 818-6, and DIN EN 818-7 must be observed, as well as the operating instructions of the hoist and any national or local rules and regulations.

The hoist chain should be checked at regular intervals according to the accident prevention rules and regulations. The minimum requirement here is an inspection within one year.

Depending on the operating and environmental conditions (multi-shift, automatic or continuous operation, corrosion, heat, etc.), the hoist chain should be checked at shorter intervals.

Inspection intervals are to be defined by the operator in these cases.

Shorter inspection intervals are recommended, unless empirical values are not available.

The inspection should include checking the dimensional accuracy, deformation, and a visual inspection concerning any possible cracks, notches or similar visual aspects.

The inspection must include the entire chain length in order to be effective.

Defects must be repaired immediately, before further operation of the hoist.

After three years, at the latest, an additional inspection for cracks must also be carried out.

The hoist chain must be discarded if the average diameter (d_m) at any point of an individual chain link is less than the nominal thickness (d_n) by more than 10%.

The formula for this is as follows:

$$d_m = (d_1 + d_2) / 2 < 0.9 \times d_n$$

(d_1 and d_2 are to be determined at an offset of 90° to one another in the same cross-section)

The hoist chain must also be discarded if the inner pitch of a single chain link has become enlarged by more than 5% or if any measurement distance across 11 chain links (sum across 11 internal pitches) has increased by more than 2%.

Hoist manufacturers usually provide exact dimensional values in their operating instructions, or corresponding gauges are available.

The wear of the wheels should be checked if possible during a chain inspection.

If the chain drive is maintained well, used chain wheels can certainly be used with a new hoist chain. However, it is to be assumed that the service life of new hoist chains with used wheels is lower than with new wheels.

Storage:

Store hoist chains in a dry location at temperatures between 0 and 40 °C..



Please refer to our operating instructions for further information on the use and maintenance of hoist chains in the THIELE download-center on our website www.THIELE.de





THIELE Hand Hoists



THIELE Hand Hoists

The THIELE Lever Blocks and Chain Blocks are equipped with an Overload Protection.

Advantages of the Overload Protection:

- + Protects the operator from injury
- + Prevents the hoist to be overloaded to a point when it becomes dangerous
- + Protects the hoist from damages
- + Provides additionally safety
- + Longer service life compared to non overload protected devices
- + Complies with DIN EN 13157, DGUV 54 und GPSG



label

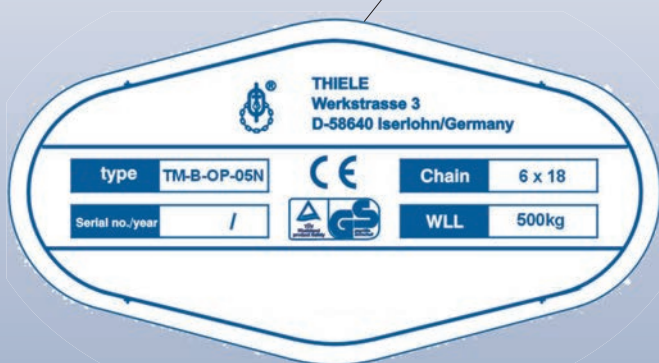



THIELE Hand Hoists

TM Chain Block TWN 1000 TM Lever Block TWN 1001



Advantages for your Application:

- + With overload protection*
- + Lightweight robust steel construction
- + Super strength THIELE alloy load chain as per EN818-7, galvanized
- + Minimum headroom
- + Minimum effort to raise maximum load by easy handling
- + Hooks with strong cast steel safety latches
- + Lower hook easy turnable with roller bearing
- + Also approved for tensioning as per EN 12195 (only TM-Lever Block)
- + Fully enclosed gear train (TM-Chain Block only)
- + Protected automatic weston brake with unique twin pawls
- + galvanised handchain as standard (TM-chain block only)
- + Durable baked enamel paint protection
- + Spare parts available
- + TÜV / GS / CE approved
- + Supplied with THIELE test certificates
- + Manuals available in 5 languages



TM Chain Block
Capacities 500 kg to 5 tonnes



TM Lever Block
Capacities 250 kg to 6 tonnes

*Except TM-LB 250 kg.



THIELE Hand Hoists

TM Chain Block TWN 1000

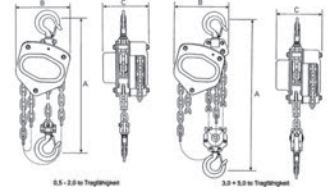

	Unit	TM-B-OP 05N	TM-B-OP 10N	TM-B-OP 20N	TM-B-OP 30N	TM-B-OP 50N
Working Load Limit	[t max.]	0,5	1,0	2,0	3,0	5,0
Lift app. 3,05 m	[Article-No.]	F063511	F063611	F063711	F063811	F063911
Lift app. 4,6 m	[Article-No.]	F063512	F063612	F063712	F063812	F063912
Lift app. 6,10 m	[Article-No.]	F063513	F063613	F063713	F063813	F063913
Lift app. 9,10 m	[Article-No.]	F063514	F063614	F063714	F063814	F063914
Lift app. 12,20 m	[Article-No.]	F063515	F063615	F063715	F063815	F063915
Chain Falls	[pieces]	1	1	1	2	2
Effort to lift for max. Working Load	[kgs]	23	30	35	27	41
Loadchain diameter	[mm]	6	6	8	8	10
Headroom (A)	[mm]	270	317	414	465	636
Width (B)	[mm]	127	158	187	210	288
Depth (C)	[mm]	131	140	161	161	190
Hook opening (upper)	[mm]	36	42	46	54	64
Hook opening (lower)	[mm]	36	42	46	54	64
Net weight (for lift 3,05 m)	[kgs]	10	12	22	32	46

TM Lever Block TWN 1001

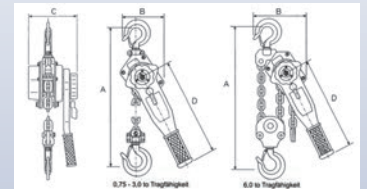

	Unit	TM-LB 025*	TM-LB-OP 075N	TM-LB-OP 150N	TM-LB-OP 300N	TM-LB-OP 600N
Working Load Limit (Lashing Capacity)	[t max.]	0,25	0,75	1,5	3,0	6,0
Lift app. 1,50 m	[Article-No.]	F061901	F062411	F062511	F062611	F062711
Lift app. 3,05 m	[Article-No.]	F061902	F062412	F062512	F062612	F062712
Lift app. 4,60 m	[Article-No.]	F061903	F062413	F062513	F062613	F062713
Lift app. 6,10 m	[Article-No.]	F061904	F062414	F062514	F062614	F062714
Falls of chain	[pieces]	1	1	1	1	2
Effort to lift for max. Working Load	[kgs]	2,5	14	22	32	34
Loadchain diameter	[mm]	4	6	8	10	10
Length of lever handle (D)	[mm]	160	280	410	410	410
Headroom (A)	[mm]	230	325	380	480	620
Width (B)	[mm]	85	136	160	180	235
Depth (C)	[mm]	92	148	172	200	200
Hook opening (upper)	[mm]	25	42	46	54	62
Hook opening (lower)	[mm]	25	42	46	54	62
Net weight	[kgs]	1,8	7	11	21	31

*Without overload protection.



THIELE Hand Hoists

Load Chain Mounting TM Chain Block TWN 1000

Chain Schema



1. The mounting of the load chain is described in direction from hook to anchorage.
2. Pay attention not to twist the load chain.
3. The load chain will be carried by the sprocket in case of operation of the hand chain. It will be guided by the guide rollers.
4. Load chain ends should be fixed with bolts and split pins.
5. The load chain should be lubricated for the first use.

Course of Action

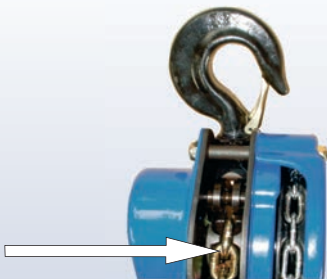

Position of Chain End

1. vertical load chain end; welding-zone of all vertical chain links face outwards



Position of Chain and Guide Roller No. 1

- guide roller No. 1
- Load chain below guide roller No. 1.

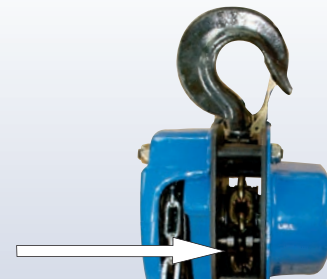

Position of Chain and Guide Roller No. 2

- guide roller No. 2
- Load chain below guide roller No. 2!
- Load chain below of anchorage; will be fixed at anchorage later

Control



Right side view:
Hook / Bottom block in front

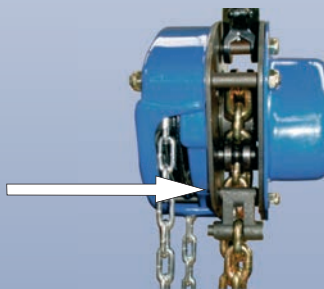

Left side view:
Anchorage in front



THIELE Hand Hoists

Load Chain Mounting TM-Lever Block TWN 1001

Chain Schema

TM-LB 025
 TM-LB-OP 075N
 TM-LB-OP 150N
 TM-LB-OP 300N



Chain Schema

TM-LB-OP 600N



Course of Action

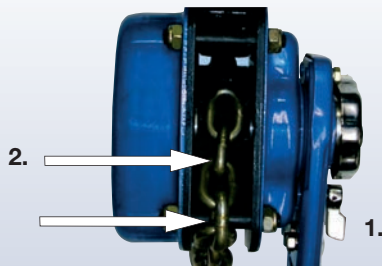

1. Switch direction-lever to „N“-position for load chain mounting.

2. Insert the load chain end to the sprocket, so that the welding zones of the vertical chain links face outwards.

3. Further move the load chain by turning the hand wheel.



4. TM-LB 025, TM-LB-OP 075N to TM-LB-OP 300N:
 Fix load chain end to hook.

TM-LB-OP 600N:
 Move load chain through bottom block and fix chain end to the top hook.
 Pay attention not to twist the chain. If necessary, shorten the chain by one link.



5. Fix loose load chain end by bolt and split pin to the chain ring
 (TM-LB 025: only spring ring).

6. The load chain should be lubricated for the first use.

THIELE Hand Hoists

TM Girder Clamp

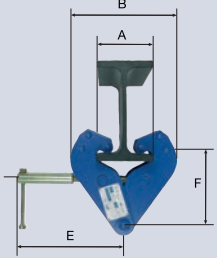
Trade Size	Article-No.	Working Load Limit [t max.]	Dimensions [mm]				Adjustable beam width [mm]	Weight app. [kgs]	TWN 0899
			A	B	E	F			
1	Z08133	1,00	278	182	217	90	75-230	4,5	
2	Z08134	2,00	278	182	217	90	75-230	5,0	
3	Z08135	3,00	356	220	277	145	80-320	9,5	
5	Z08136	5,00	356	220	277	145	90-320	11,0	

TM Display

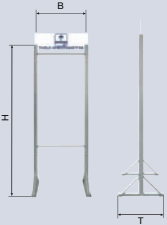
Article-No.	B	Dimensions [mm]		Weight app. [kgs]	
		H	T		
F918186	640	1700	490	21	



Modular
plug-in unit

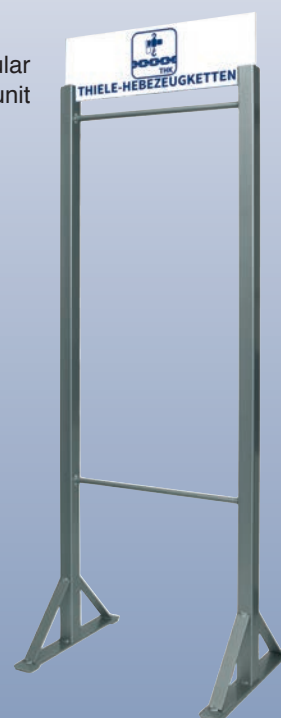





THIELE Hand Hoists

Spare Parts TM Series for Chain Blocks TWN 1000

Article-No.	for TM-Chain Block Type	Weight app. [kgs]	TWN 1010
Z06928	TM-B-OP 05N	0,06	 <p>Ratchet Disc Part-No. 17 (previously Part-No. 27)</p>
Z06929	TM-B-OP 10N	0,09	
Z06930	TM-B-OP 20N	0,15	
Z06931	TM-B-OP 30N	0,15	
Z06932	TM-B-OP 50N	0,19	

Article-No.	for TM-Chain Block Type	Weight app. [kgs]	TWN 1011
Z06934	TM-B-OP 05N	0,01	 <p>Friction Plate Part-No. 16 (previously Part-No. 28)</p>
Z06935	TM-B-OP 10N	0,02	
Z06936	TM-B-OP 20N	0,03	
Z06937	TM-B-OP 30N	0,03	
Z06938	TM-B-OP 50N	0,03	

Article-No.	for TM-Chain Block Type	Working Load Limit [t max.]	Weight app. [kgs]	TWN 1015
Z09939	TM-B-OP 05N	0,5	0,34	 <p>Hitches acc. to DIN 74054 Part 1 and Part 2</p>
Z09940	TM-B-OP 10N	1,0	0,52	
Z09941	TM-B-OP 20N	2,0	0,81	
Z09942	TM-B-OP 30N	3,0	1,90	
Z09943	TM-B-OP 50N	5,0	11,50	

Article-No.	for TM-Chain Block Type	Weight app. [kgs]	TWN 1013
Z09944	TM-B-OP 05N	0,02	 <p>Safety Clip Part-No. 7N (previously Part-No. 8N)</p>
Z09945	TM-B-OP 10N	0,03	
Z09946	TM-B-OP 20N	0,04	
Z09947	TM-B-OP 30N	0,05	
Z09948	TM-B-OP 50N	0,10	

Article-No.	for TM-Chain Block Type	Working Load Limit [t max.]	Weight app. [kgs]	TWN 1017
Z09949	TM-B-OP 05N	0,50	0,35	 <p>Bottom Hook Assy Part-No. 8N (previously Part-No. 7N)</p>
Z09950	TM-B-OP 10N	1,00	0,58	
Z09951	TM-B-OP 20N	2,00	0,85	
Z09952	TM-B-OP 30N	3,00	2,03	
Z09953	TM-B-OP 50N	5,00	13,90	

THIELE Hand Hoists

Spare Parts TM Series for Lever Blocks TWN 1001

Article-No.	for TM-Lever Block Type	Weight app. [kgs]	TWN 1012
Z09455	TM-LB-OP 075N	0,13	 <p>Ratchet Disc Assy. Part 21N (previously Part-No. T17 and T18)</p>
Z09454	TM-LB-OP 150N	0,20	
Z09456	TM-LB-OP 300N/600N	0,25	

Article-No.	for TM-Lever Block Type	Working Load Limit [t max.]	Weight app. [kgs]	TWN 1016
Z09968	TM-LB-OP 075N	0,75	0,49	 <p>Top Hook Assy Part-No. 8N (previously Part-No. 31N)</p>
Z09969	TM-LB-OP 150N	1,50	0,88	
Z09970	TM-LB-OP 300N	3,00	2,20	
Z09971	TM-LB-OP 600N	6,00	4,50	

Article-No.	for TM-Lever Block Type	Working Load Limit [t max.]	Weight app. [kgs]	TWN 1018
Z09972	TM-LB-OP 075N	0,50	0,50	 <p>Bottom Hook Assy Part-No. 10N (previously Part-No. 33N)</p>
Z09973	TM-LB-OP 150N	1,50	0,95	
Z09974	TM-LB-OP 300N	3,00	2,50	
Z09975	TM-LB-OP 600N	6,00	6,70	









Article-No.	for TM-Lever Block Type	Weight app. [kgs]	TWN 1014
Z09976	TM-LB-OP 075N	0,03	 <p>Safety Clip Part-No. 9N (previously Part-No. 61N)</p>
Z09977	TM-LB-OP 150N	0,04	
Z09978	TM-LB-OP 300N	0,05	
Z09979	TM-LB-OP 600N	0,06	



THIELE Lashing Products



Product Overview of Lashing Products

Content	from Page
General Information	165
Grade 80 Lashing Chains and Components	
 Lashing Chains	176
 Round Steel Link Chains (TWN 0805)	177
 Chain Tensioners (TWN 1450, TWN 1451, TWN 1452)	178
 Hooks (TWN 1340/1)	179
 Shortening Components (TWN 0827/1)	179
 Connectors (TWN 1320)	180
 Lifting Points (TWN 0119, TWN 0124)	180
 Special Components (TWN 0869)	181
Grade 100 Lashing Chains and Components	
 Lashing Chains	182
 Round Steel Link Chains (TWN 1805)	183
 Chain Tensioners (TWN 1454, TWN 1455)	184
 Hooks, (TWN 1840/1)	185
 Connector (TWN 1820)	185
 Shortening Components (TWN 1827/1, TWN 1852)	186
 Lashing Points (TWN 1473, TWN 1880, TWN 1471, TWN 1474)	187
 Special Sling Components (TWN 1869)	189
Tensioning Components	
 Lever Blocks (TWN 1001)	190

General Information

The Securing of Loads with THIELE Lashing Products



Load securing requires measures aimed at safeguarding the load against physical forces of movement arising during transport.

Nevertheless, vehicles are encountered on our roads every day that are carrying insufficiently secured loads or loads not safeguarded at all. More often than not, changes in speed or direction produce forces causing the cargo to no longer stay in place but move irregularly on the vehicle.

To avoid this risk, every load has to be secured on the carrier irrespective of whether it is light or

heavy and even when the vehicle runs at low speed. The conditions on which load securing methods are based apply to normal vehicle operation. However, „normal vehicle operation“ as a rule does not mean the carrier always travels evenly and foresightedly. Usual traffic conditions undoubtedly include full braking, uneven road surfaces, extreme evasion maneuvers and the like.

Measures implemented to secure loads must take all these conditions into account and if securing proves ineffective, insurance cover may be lost partly or even entirely. In such a case the relevant company or private person must bear the arising costs alone which may often lead to their economic ruin.

It is still not sufficiently known to all those concerned that the responsibility for load securing does not only lie with the driver of a vehicle but with all other participants in the forwarding chain as well (e.g. owner, sender, carrier, hauler etc.).



Physical Basics

THIELO, expert on Load Securing, informs us about some Physical Fundamentals that are good to know.

In the event of an emergency braking operation of the vehicle down to zero speed deceleration rates of up to 8 m/s^2 may arise. To put it in another way, 80 % of the weight of a given cargo component has to be absorbed by means of suitable securing means to prevent the load from sliding forward.

The centrifugal forces acting transversely to the direction of travel when a vehicle passes through turns must also be taken into account in the context of cargo securing. The design of commercial vehicles permits building up rates of acceleration in the range of up to 5 m/s^2 . This means that 50 % of the cargo weight has to be secured transversely to the direction of travel.

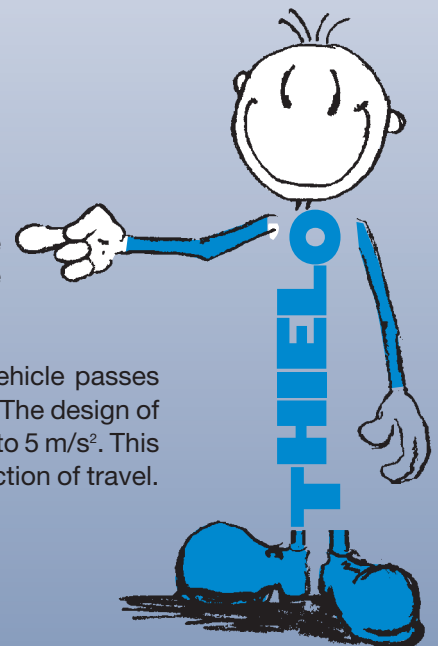

General Information

Arising Forces when Driving

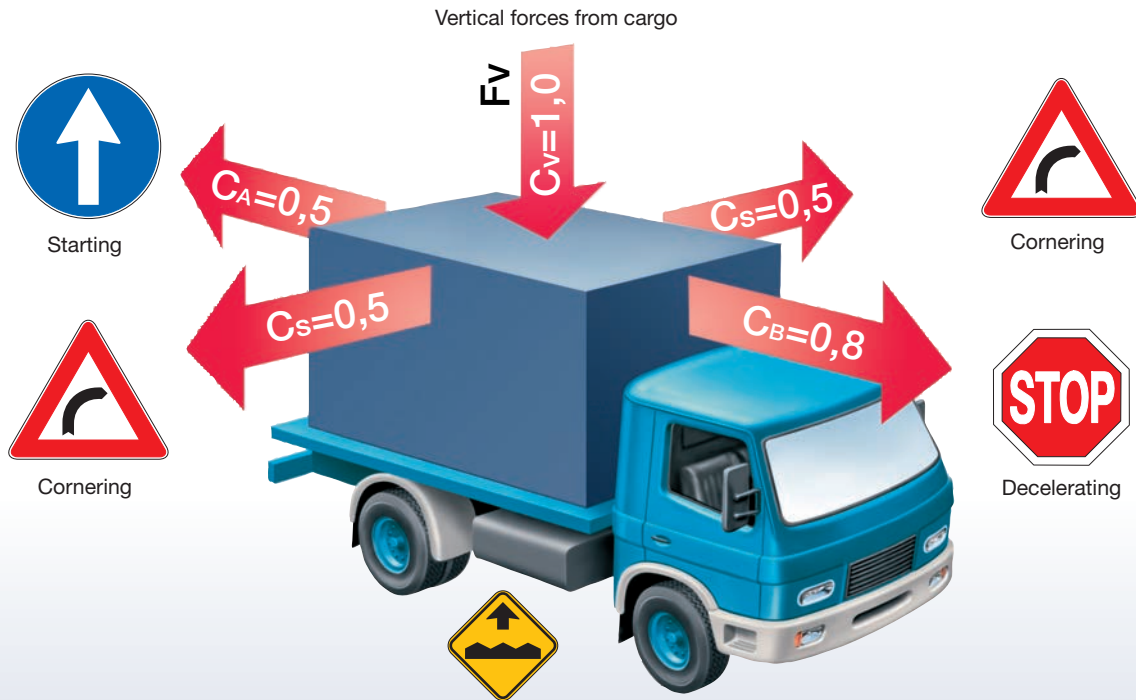

Starting

Weight forces (acceleration force) to the rear
 $F_A = 0.5 \times F_V = 50\%$ of the cargo weight

Decelerating

Weight forces (deceleration force / negative acceleration) to the front
 $F_B = 0.8 \times F_V = 80\%$ of the cargo weight

Cornering

Weight forces (centrifugal force) acting sideways
 $F_S = 0.5 \times F_V = 50\%$ of the cargo weight

Accordingly, assuming a cargo weight F_V of $m = 15.000$ kgs, 15.000 daN will exert thrusting or pushing forces as follows:

Forces of Cargo

Cargo Weight [%]	Forces of Cargo	Force [daN min.]
100	Vertical force of cargo	$F_V = 15.000$
80	Longitudinal forward force	$F_B = 12.000$
50	Transverse force of cargo (right/left)	$F_S = 7.500$
50	Longitudinal rearward force	$F_A = 7.500$

Table 1

All these forces must be retained by means of load securing or lashing devices.



General Information

Securing Methods

Basically, a distinction is to be made between force- and form-closed cargo securing.

Force closure → Tie-down lashing

Form closure → Direct lashing

Tie-down Lashing

The perhaps most commonly used load securing method is tie-down lashing (see pic. 1 and 2).

The load securing devices are arranged over the cargo, attached to lashing fixtures and then tightened using maximum hand force.

The pre-tensioning force thus applied acts additionally to the weight force causing the cargo to be pressed onto the load area and frictional forces to increase. The sum from the weight and pressing forces takes effect in „all directions“. This in particular is the major advantage of the tie-down lashing method.

Vertical angle α primarily determines the effectiveness of the tie-down lashing method. When using a 90° angle 100% of the force introduced into the lashing system takes effect, at 30° this is only 50%. For this reason, the lashing angle β should never be less than 30° .

Moreover, the following should be considered for tie-down lashing operations:

- A high degree of friction must exist between the cargo and the load area as well as between the individual cargo components.
- The sliding friction coefficient must be known or well assessable.
- The cargo must be capable of withstanding high pre-tensioning forces.
- The lashing points on the vehicle must be designed to take the arising loads.
- Due to settling processes, the pre-tension of the load securing device must be regularly checked during transit so as to rule out that pre-tensioning forces will decrease and no longer be adequate.



The magnitude of the frictional force depends on the characteristics of the materials in contact with each other. It is clearly evident that a piece of metal will easier slide to and from a metal surface than on a surface consisting of rubber.

In practical testing on load surfaces as well as in laboratory tests a multitude of so-called sliding friction coefficients have been determined which serve as calculation basis for cargo securing purposes. These coefficients are identified by the symbol μ_D .

Dynamic friction coefficients of common cargo

Material pairing	Sliding friction coefficient (μ_D)
Steel on steel, oiled	0.10
Timber on steel plates	0.30
Steel on wood	0.40
Pre-cast concrete component with wood interlayer on wood (concrete/wood/wood)	0.40
Concrete on lattice beam	0.60

Table 2



General Information

Tie-down Lashing

Force introduction via the tensioning element

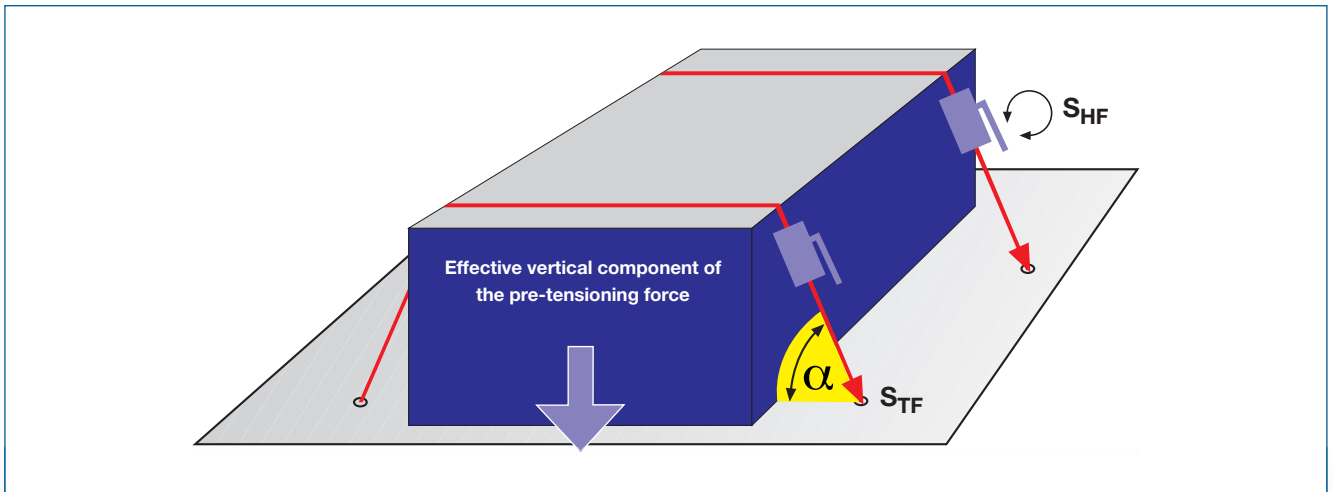

pic. 1

Due to the lashing angles tie-down lashing requires high pre-tensioning forces.

S_{HF} = Standard Hand Force (max. 50 daN) applied to the lever of the ratchet or screw tensioner. Only, if the tensioning element is tightened by hand (S_{HF}) at 50 daN can the pretensioning force (S_{TF}) indicated on the identification tag be reached.

S_{TF} = Standard Tension Force = Remaining force after the lever of the tensioning device has been released; i.e. the actually remaining force exerted by the load securing device.

The pre-tensioning force **F_T** is determined according to the following equation:

$$F_T \geq \frac{C_{A,S} - \mu_D}{\mu_D \times \sin \alpha} \times \frac{F_V}{k \times n} \quad [\text{daN max.}]$$

The meaning of formular symbols:

$C_{A,S}^*$ = Acceleration coefficient (in travel direction $C_A = 0.8$; transversely and counter to the drive direction $C_S = 0.5$)

C_V^* = Acceleration coefficient, vertical

μ_D = Dynamic friction coefficient (sliding friction coefficient)

$\sin \alpha$ = Sine function of the lashing angle

F_V = Vertical force of the cargo (cargo weight) ; ($F_V = m \times g \times C_V$)

k = Transfer coefficient (loss of pre-tensioning force due to friction between cargo and load securing device)
1.5 times if the load securing device is tightened by means of a tensioning device

n = number of lashing devices

*Assumption: Cargo on road trucks and trailers

General Information

Tie-down Lashing

Over-the-top lashing

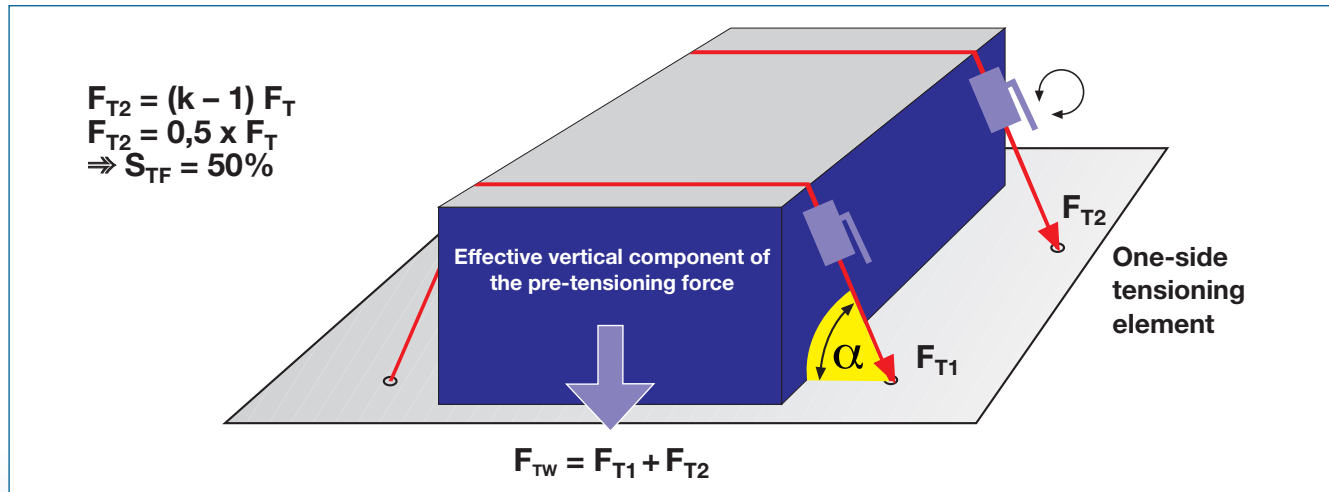

pic. 2

Pre-tensioning forces

Table 3 provides estimated pre-tensioning forces that are required to safely secure cargo.

Cargo-weight (F_V) [daN max.]	Sliding-friction coefficient [μ_D]	Lashing angle [α]	Total pretensioning force [daN max.]	Lashing angle [α]	Total pretensioning force [daN max.]
2.000	0,10	50°	12185	80°	9485
	0,40	50°	1745	80°	1355
	0,60	50°	580	80°	455
10.000	0,10	50°	60925	80°	47425
	0,40	50°	8725	80°	6775
	0,60	50°	2900	80°	2275
30.000	0,10	50°	182775	80°	142275
	0,40	50°	26175	80°	20325
	0,60	50°	8700	80°	6825

The data shown is based on material pairings listed in Table 2.

Table 3

As is evident from Table 3, the sliding friction coefficient and lashing angle are decisive significance!

Reach your destination with your cargo
safely secured!





General Information

Tie-down Lashing

Pre-tensioning forces

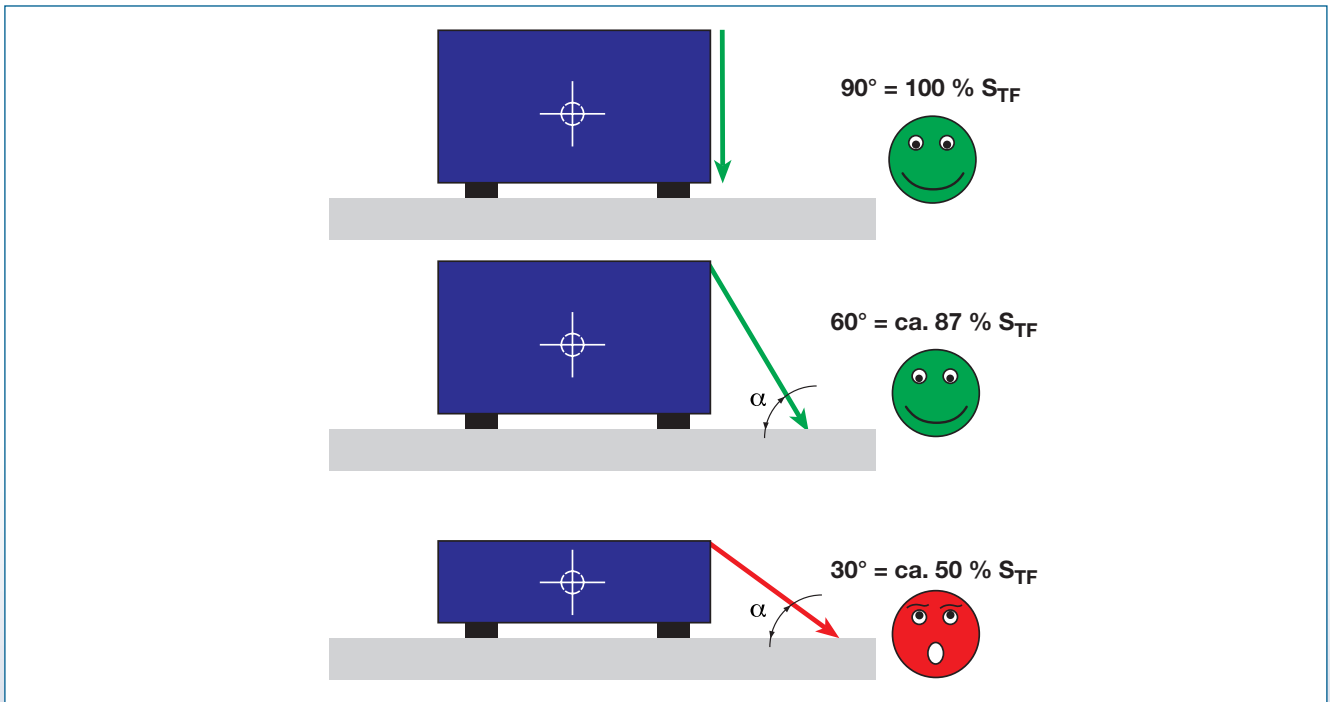

pic. 3

As is evident, significantly high pre-tensioning forces are sometimes needed and it is obvious that such forces can only be applied with appropriately sized load securing device.

The most important parameters of load securing device are as follows:

Lashing Capacity (LC)

Lashing Capacity in [daN]

Standard Tension Force (S_{TF})

S_{TF} min. = $0,25 \times LC$ for chains of diameter = 6 to 10 mm

min. = $0,15 \times LC$ for chains of diameter = 13 and 16 mm

S_{TF} max. = $0,50 \times LC$

Both characteristics can be seen from the identification tag of the chain. The lashing force is the largest force in straight pull, for which a lashing device is designed to use. The Standard Tension Force (S_{TF}) is the force that remains in the load securing device when the tensioning lever has been released, i.e. the actually remaining force exerted by the system.

To determine how many lashing elements are needed, the calculated total pre-tensioning force must be divided by the standard tension force of the load securing device selected. During the use of belt systems, a double-digit number of belts can be necessary for common loads.

This is no doubt completely unsuitable for practical purposes. However, using THIELE-lashing chains may reduce the required number of tensioners by a factor eight. Nevertheless, it is generally recommended to use anti-slip mats for tie-down lashing and direct lashing to increase the coefficient of friction.

General Information

Direct Lashing

Direct lashing is a highly effective cargo securing method, because it makes use of the lashing capacity of the lashing device. Since the load securing device is not pre-tensioned, only little manual power is needed for tightening. The lashing device must be fixed onto a lashing point at the load area and then at the load itself. It shall only be pretensioned by handforce in order to avoid sagging or swinging of the chain.

The design prerequisite for a chain to be used as a safety device is the lashing capacity (LC). The lashing capacity is the decisive parameter for the chain size as well as for the related tensioning and connecting elements.

Diagonal Lashing

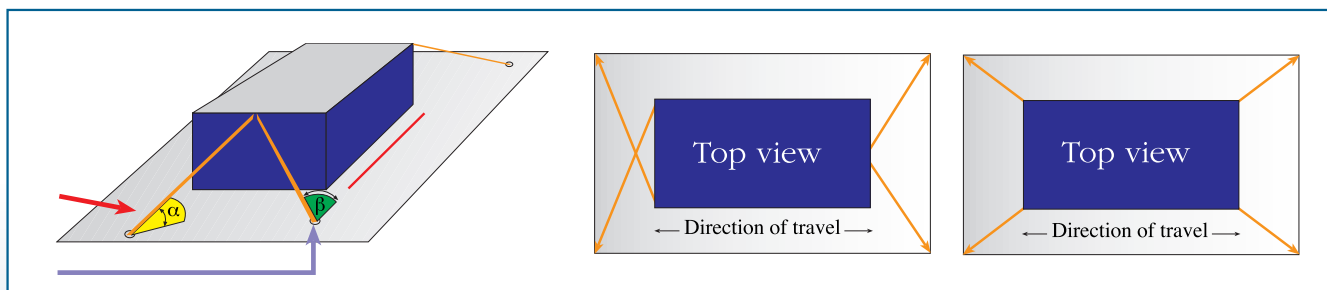

pic. 4

In this case, physical laws prescribe the limits according to which the lashing angles should be selected. Calculations show that it is recommended to keep horizontal angles in line between 20° and 45°. If the angle is smaller than 20° and the friction coefficient is smaller than 0.5, an additional dimensioning of the average lashing force against slipping during vehicle cornering is requested. If, on the other hand, the angle is larger than 60°, the lashing capacity will increase unproportionally high. Theoretically, they would even be infinitely larger in the case of a 90° angle. Based on these considerations, it can be said that the frequently applied diagonal/cross-wise lashing method for securing of load in travel direction is not favorable, at least in its extreme configuration (horizontal angle).

There are also recommended limits at the vertical angle which can lead to disproportional increase of the forces in the tensioning device. Certainly, the best use of the average lashing capacities is at a vertical angle between 0° and 30°.

The requested lashing capacity (LC) is calculated according to the following formula, considering the described factors:

$$LC \geq \frac{F_V \text{ [daN]} \times (C_{A,S} - \mu_D)}{(\sin \alpha \times \mu_D + \cos \alpha \times \cos \beta) \times n}$$

Based on the formula above, a lashing device that will have at least the same admissible lashing capacity must be selected.

Symbols used in the formula:

LC = Lashing Capacity

F_V = Vertical force of the cargo (cargo weight); ($F_V = m \times g \times c_V$)

μ_D = Dynamic friction coefficient (sliding friction coefficient)

$C_{A,S}^*$ = Acceleration coefficient (in travel direction $C_A = 0.8$; transversely and counter to the travel direction $C_S = 0.5$)

C_V^* = Acceleration coefficient, vertical

α = Vertical angle of the lashing legs

β = Horizontal angle of the lashing legs

n = Number of lashing chains in the respective direction

*Assumption: Cargo on road trucks and trailers





General Information

Load Securing Device

Lashing chains are elements best suited for securing of loads. They offer major advantage because their working capacity is known which allows an exact calculation of the securing of load.

For standard lashing chains exclusively shortlink round steel chains to DIN EN 818-2 or PAS 1061 must be used. Longlink round steel chains are to be used for log transportation only.

In the interest of your own as well as public safety, exclusively use the shortening elements according to DIN EN 1677-1 for the shortening of a lashing chain offered and approved by the chain manufacturer. If using self-made shorteners, the capacity of the lashing device can no longer be granted.

When using lashing hooks, all safety requirements according to DIN EN 1677-2 are observed (hook with safety latch) and taken into consideration.

Connecting and shortening parts must have devices preventing them from unintentional release.

Screw tensioners must have a safety device (securing of screw removal) against unintentional release.

Multi purpose ratchet hoists must also meet EN 13157 requirements.

The complete Lashing Chain to DIN EN 12195-3 consists of:

Load Securing Devices	Tensioning Elements	Connecting Elements	Identification Tags
Round steel chains	Tighteners, Tensioners, Multi purpose ratchet hoists	Hooks, Shackles, Chain shorteners, End-links	Metal tags





General Information

Inspection of Lashing Chains

Due to use, load securing devices are also subject to a certain amount of wear and can be damaged by improper use. It is thus strictly required that round steel chains as well as components are inspected at regular intervals by a qualified person to make sure they are taken out of service or repaired without delay when damaged or worn out.

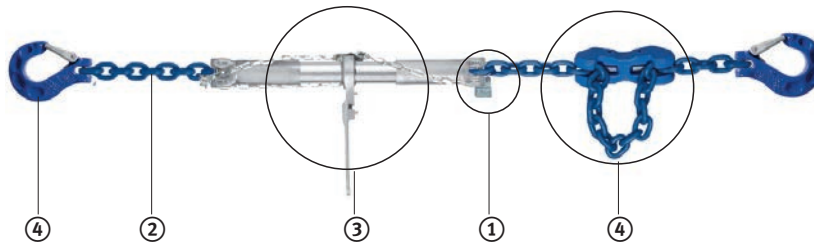

Criteria for rejection from operation:

Component:	Indicators:
1. Identification Tag - Tag conforming to standard	> Missing or illegible tags
2. Load Securing Device - Round steel chain	> Elongation of a single link at the outer length more than 3% > Elongation of a single link in the pitch more than 5% > Wear exceeding 10% of nominal diameter > Visible deformation > Surface cracks
3. Tensioning Element - Tensioner - Tightener - Multi Purpose ratchet hoist	> Deformation > Cracks > Severe signs of wear > Severe corrosion
4. Component - End link - Chain connector - Shackle - Shortening claw - Shortening hook - Lashing hook	> Deformation > Cracks > Severe signs of wear > Severe corrosion > Hook widening by more than 10%





General Information

Inspection of Lashing Chains

Do NOT use...

... round steel chains

- with working load limit or lashing capacity lower than specified in the Grade 80 standard EN 818-2
- without manufacturer's name

... tensioning elements

- without screw removal mechanism
- without manufacturer's name
- with long handles that are capable of producing a pre-tensioning force over $0.5 \times LC$

... shortening components or lashing hooks

- which may reduce the breaking force of the chain
- without safety latches or locking pins

Lashing Hooks / Sling Hooks

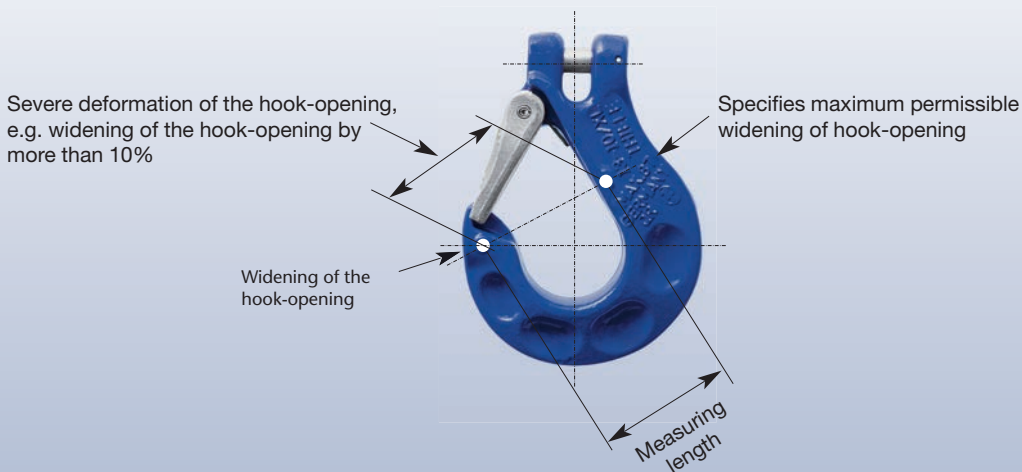

The embossed maximum permissible limit with measuring points enables an easy check of the hook-opening.

Repair work must exclusively be performed by qualified personnel. Only clearly identifiable lashing chains are allowed to be repaired.

THIELE offers regular in-house and on-site competence training.

More detailed information regarding the inspection of lashing chains are provided in the respective chain operating instructions.

All operation manuals are available in the THIELE download-center on our website www.THIELE.de



General Information

Identification Tag

THIELE lashing chains are equipped with an identification tag specifying the chain's performance characteristics. Therefore a clear identification of the chain is given and mix-up is avoided. Information on the chain tag and how to use this information is shown below. Since July 1st, 2001 the information on the tag is required according to DIN EN 12195-3.

Identification Tag according to DIN EN 12195-3

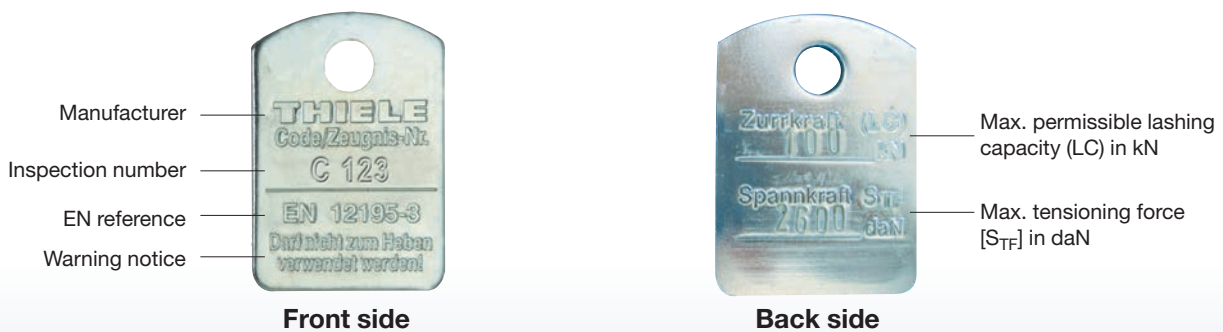

Tags as per DIN EN 12195-3 show on their front the number of the standard specification, the name of the chain manufacturer, the inspection number, as well as a warning that the chain must not be used for lifting. On the back-side of the tag the maximum permissible lashing capacity (LC) in kN and the maximum standard tension force [S_{TF}] in daN is hardstamped.



How to Use Lashing Chains

To make sure lashing chains have a long service life without wear and damage there are some aspects to be observed when handling these chains.

- Do not overload lashing chains.
- The maximum hand force of 50 daN must only be applied with one hand. Using bars, levers or similar tools is prohibited.
- Make sure the lashing chain cannot damage the cargo and vice versa.
- Make use of e.g. edge protectors to prevent damage to the cargo and wear to chain and cargo.
- Never use chains with knots or chains connected by screws, bolts or similar.
- To shorten chains, exclusively use the shortening elements offered and approved by the chain manufacturer, otherwise the safety of the chain cannot be warranted.



Grade 80 Lashing Chains and Components

Lashing Chains

Trade Size	Article-No.	Lashing Capacity (LC) under straight load [kN max.]	Weight app. [kgs]	TWN 1400
8-8	F34171	40	8,50	 <p>Lashing Chain with Tensioner</p>
10-8	F34172	63	12,50	
13-8	F34173	100	21,00	
16-8	F34174	160	37,70	

Trade Size	Article-No.	Lashing Capacity (LC) under straight load [kN max.]	Weight app. [kgs]	TWN 1401
8-8	F34171R	40	8,50	 <p>Lashing Chain with Ratchet</p>
10-8	F34172R	63	12,50	
13-8	F34173R	100	21,00	

Trade Size	Article-No.	Packaging Unit	Weight app. [kgs]	TWN 1402
-	Z07264	-	0,05	 <p>Identification Tag</p>

Note: Identification tag for lashing chains acc. to EN 12195-3.

Grade 80 Lashing Chains and Components

Load Reductions

Temperature Application Range

Temperature Application Range	Working Load Limit
-40°C to 200°C	100 %
over 200°C to 300°C	90 %
over 300°C to 380°C	75 %

If Grade 80 - alloy slings are used at temperatures exceeding 200°C, then the working load limit has to be reduced.
Safe working load indicated in % acc. to tables 1, 2 or 3 by chain temperatures of:

Load Factor at Asymmetry

No. of Legs	1		2		3		4			
	Inclination Angle β	Load Factor	Inclination Angle β	Load Factor	Inclination Angle β	Load Factor	Inclination Angle β	Load Factor		
	-	1	0° – 45°	1	45° – 60°	1	0° – 45°	1,4	45° – 60°	1

Grade 80 Round Steel Link Chains TWN 0805



Trade Size	Article-No.			Nominal Size		Pitch		Inside Width	Outside Width	Working Load Limit [t max.]	Weight app. [kgs]
	self-coloured	RAL 9005	corrothiel	d [mm]	tol. \pm [mm]	p [mm]	tol. \pm [mm]	w ₁ [mm min.]	w ₂ [mm max.]		
6-8	F01452	F01453	F01454	6,00	0,24	18,00	0,5	7,80	22,20	1,12	0,8
7-8	F01458	F01459	F01457	7,20	0,20	21,80	0,6	9,45	25,20	1,50	1,1
8-8	F01464	F01465	F01429	8,00	0,32	24,00	0,7	10,40	29,60	2,00	1,4
10-8	F01469	F01470	F01450	10,00	0,40	30,00	0,9	13,00	37,00	3,15	2,2
13-8	F01474	F01475	F01476	13,00	0,52	39,00	1,2	16,90	48,10	5,30	3,8
16-8	F01479	F01480	F01487	16,00	0,64	48,00	1,4	20,80	59,20	8,00	5,7
18-8	F01484	F01485	F04580	18,00	0,90	54,00	1,6	23,40	66,60	10,00	7,3
20-8	F01494	F01495	F04606	20,00	1,00	60,00	1,8	26,00	74,00	12,50	9,0
22-8	F01499	F01500	F04629	22,00	1,10	66,00	2,0	28,60	81,40	15,00	10,9
26-8	F01514	F01515	F04695	26,00	1,30	78,00	2,3	33,80	96,20	21,20	15,2
28-8*	F01519	F01520	F01521	28,00	1,40	84,00	2,5	36,40	104,00	25,00	17,6
32-8	F01524	F01525	F01526	32,00	1,60	96,00	2,9	41,60	118,00	31,50	23,0
36-8*	F01529	F01530	F04814	36,00	1,80	108,00	3,0	46,80	133,00	40,00	29,0
40-8*	F01534	F01535	F04838	40,00	2,00	120,00	4,0	52,00	148,00	50,00	36,0
45-8*	F01539	F01540	F04889	45,00	2,30	135,00	4,0	58,50	167,00	63,00	45,5
50-8*	F01545	F01546	F04900	50,00	2,50	150,00	4,5	67,50	180,00	80,00	56,0
56-8*	F01555	F01556	F04908	56,00	2,80	170,00	5,0	75,60	201,60	100,00	72,5
63-8*	-	F01566	-	63,00	3,20	190,00	6,0	88,00	230,00	125,00	89,0
71-8*	-	F01598	-	71,00	3,60	210,00	6,0	99,00	260,00	160,00	110,0

*These sling chains are only available in welded finish

Elongation at break, self coloured: min. 25%; bright finished: min 20%.

Factor: Working Load Limit : Proof Force : Breaking Force = 1 : 2,5 : 4 (200 : 500 : 800 N/mm²);



Grade 80 Lashing Chains and Components

Chain Tensioners

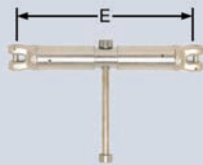
Trade Size	Article-No.	Norm. straight load (S_{Tr}) [daN min.]	Tensioner under straight load [kN max.]	Dimensions [mm]			Weight app. [kgs]	TWN 1450
				$E_{max.}$	$E_{min.}$	lift		
8-8	F34179	1800	40	345	270	75	2,10	 <p>Short Chain Tensioner acc. to DIN EN 12195-3</p>
10-8	F34199	2200	63	375	275	100	2,70	
13-8	F34189	2600	100	460	340	120	4,00	

Note: Can also be used in slings; also rated for lifting.

Trade Size	Article-No.	Norm. straight load (S_{Tr}) [daN min.]	Tensioner under straight load [kN max.]	Dimensions [mm]			Weight app. [kgs]	TWN 1451
				$E_{max.}$	$E_{min.}$	lift		
8-8	F34175	1800	40	345	270	75	2,50	 <p>Short Chain Tensioner with Ratchet acc. to DIN EN 12195-3</p>
10-8	F34195	2200	63	375	275	100	3,50	
13-8	F34185	2600	100	460	340	120	5,00	

Note: Can also be used in slings; also rated for lifting.

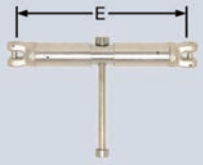
Trade Size	Article-No.	Norm. straight load (S_{Tr}) [daN min.]	Tensioner under straight load [kN max.]	Dimensions [mm]			Weight app. [kgs]	TWN 1452
				$E_{max.}$	$E_{min.}$	lift		
13-8	F341871	2600	100	675	445	230	7,20	 <p>Chain Tensioner with Spindle acc. to DIN EN 12195-3</p>
16-8	F34197	3100	160	835	555	280	11,80	

Note: Can also be used in slings; also rated for lifting.

Grade 80 Lashing Chains and Components

Hooks

New

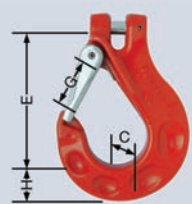
Trade Size	Article-No.	Working Load Limit [t max.]	Dimensions [mm]				Weight app. [kgs]	TWN 1340/1
			E	G	H	C		
6-8	F336010	1,12	75	24	20	17	0,36	 <p>Clevis Sling Hook with Safety Latch</p>
8-8	F336110	2,00	92	30	25	22	0,75	
10-8	F336210	3,15	113	37	32	28	1,40	
13-8	F336310	5,30	133	42	41	35	2,50	
16-8	F336410	8,00	162	51	50	41	4,40	
18-8*	F33651	10,00	195	60	52	50	7,59	
20-8*	F33656	12,50	220	65	58	55	9,68	
22-8*	F33661	15,00	244	75	64	61	10,62	

*TWN 0835/1. **Note:** The new TWN 1340/1 replaces the TWN 0835/1 (only trade sizes 6-8 to 16-8). Forged safety latch.

Shortening Components

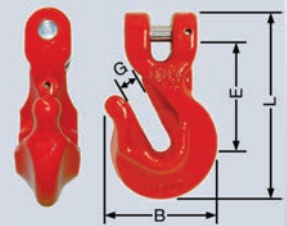
Trade Size	Article-No.	Working Load Limit [t max.]	Dimensions [mm]				Weight app. [kgs]	TWN 0827
			E	G	L	B		
8-8	F33200	2,00	61	9	101	61	0,53	 <p>Clevis Shortening Hook</p>
10-8	F33210	3,15	73	12	125	75	0,97	
13-8	F33220	5,30	95	15	160	95	2,18	
16-8	F33230	8,00	112	18	188	120	3,40	
20-8	F33245	12,50	148	22,5	242	141	7,30	

Note: With extra wide chain bed.

Trade Size	Article-No.	Working Load Limit [t max.]	Dimensions [mm]				Weight app. [kgs]	TWN 0827/1
			E	G	L	B		
8-8	F33201	2,00	61	9	101	61	0,54	 <p>Clevis Shortening Hook with Safety Pin</p>
10-8	F33211	3,15	73	12	125	75	0,99	
13-8	F33221	5,30	95	15	160	95	2,18	
16-8	F33231	8,00	112	18	188	120	3,45	
20-8	F33246	12,50	148	22,5	242	141	7,35	

Note: With extra wide chain bed, complies to DIN 5692.





Grade 80 Lashing Chains and Components

Connectors

Trade Size	Article-No.	Working Load Limit [t max.]	Dimensions [mm]						Weight app. [kgs]	TWN 1320
			E	G	A	C	B	F		
6-8	F30806	1,12	46	15	62	42	11	6	0,07	 <p>THI-LOK®</p>
7/8-8	F30816	2,00	56	20	78	55	14	9	0,16	
10-8	F30826	3,15	69	25	93	68	18	12	0,30	
13-8	F30836	5,30	84	30	116	75	23	15	0,60	
16-8	F30846	8,00	102	35	146	97	26	19	1,20	
18-8	F30850	10,00	122	36	165	110	31	22	1,86	
20-8	F30855	12,50	134	45	185	122	36	26	2,33	
22-8	F30860	15,00	145	46	198	132	38	26	3,16	
26-8	F30870	21,20	164	55	225	156	44	30	5,00	
32-8	F30880	31,50	192	65	268	192	55	37	9,33	

Lifting Points

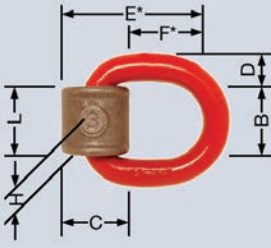
Trade Size	Art.-No.	Working Load Limit [t max.]	Lashing Capacity (LC) [daN max.]	Dimensions [mm]							Weight approx. [kgs]	TWN 0119
				E*	F*	C	L	H	D	B		
6-8	F35103	1,12	2.200	59	31	32	32	28	12	36	0,24	
8-8	F35113	2,00	4.000	69	37	38	38	33	14	42	0,46	
10-8	F35123	3,15	6.300	84	46	45	44	38	18	48	0,63	
13-8	F35133	5,30	10.000	120	69	60	60	51	24	66	1,90	
16-8	F35143	8,00	16.000	127	66	68	65	61	28	72	2,67	
22-8	F35163	15,00	-	178	98	96	109	80	39	120	8,09	
32-8	F35183	31,50	-	292	174	145	165	118	56	180	27,30	
40-8	F35193	50,00	-	371	228	186	210	145	72	230	60,00	

Note: *E- and F-Dimension vertical to the welding level.

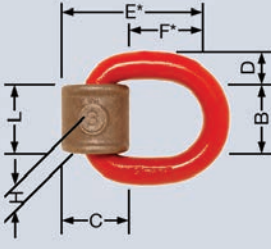
Trade Size	Art.-No.	Working Load Limit [t max.]	Lashing Capacity (LC) [daN max.]	Dimensions [mm]							Weight approx. [kgs]	TWN 0124
				E*	F*	C	L	H	D	B		
6-8	F35107	1,12	2.200	56	30	32	32	28	12	36	0,25	
8-8	F35110	2,00	4.000	67	37	38	38	33	14	42	0,43	
10-8	F35124	3,15	6.300	81	45	45	44	38	18	48	0,72	
13-8	F35139	5,30	10.000	117	69	60	60	54	24	66	1,90	
16-8	F35144	8,00	16.000	122	67	68	65	61	28	72	2,80	

Note: *E- and F-Dimension vertical to the welding level.



Grade 80 Lashing Chains and Components

Special Lifting Points

New

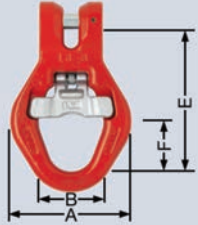
Trade Size	Article-No.	Working Load Limit [t max.]	Dimensions [mm]				Weight app. [kgs]	TWN 0869
			E	F	B	A		
13-8	F313800	5,30	142	57,5	65	122	1,92	 <p>Skip Suspension Link for one-hand use with Pin Coupling and forged Safety Latch</p>
16-8	F313850	8,00	141	57,5	65	122	1,92	







Grade 100 Lashing Chains and Components

Lashing Chains

Trade Size	Article-No.	Lashing Capacity (LC) under straight load [daN max.]	Weight app. [kgs]	TWN 1410
13-10	F34183	13.400	21,63	 <p>Lashing Chain with Tensioner</p>
16-10	F34184	20.000	39,55	

Trade Size	Article-No.	Lashing Capacity (LC) under straight load [daN max.]	Weight app. [kgs]	TWN 1411
13-10	F34183R	13.400	22,83	 <p>Lashing Chain with Ratchet</p>
16-10	F34184R	20.000	41,05	

Trade Size	Article-No.	Packaging Unit	Weight app. [kgs]	TWN 1402
-	Z07264	-	0,05	 <p>Identification Tag</p>

Note: Identification tag for lashing chains acc. to EN 12195-3.



Grade 100 Lashing Chains and Components

Round Steel Link Chains TWN 1805 acc. to PAS 1061 **XL-400**



Trade Size	Artikel-No.	Nom. Size (d) [mm]	Pitch (p) [mm]	Pitch Tol. (±) [mm]	Inside Width w ₁ [mm min.]	Outside Width w ₂ [mm max.]	Working Load Limit [t max.]	Weight app. [kg/m]
6-10	F01610B	6	18	0,5	7,80	22,20	1,40	0,9
8-10	F01615B	8	24	0,7	10,92	29,60	2,50	1,6
10-10	F01622B	10	30	0,9	13,00	37,00	4,00	2,5
13-10	F01629B	13	39	1,2	17,48	48,10	6,70	4,3
16-10	F01635B	16	48	1,4	20,80	59,20	10,00	6,5
20-10	F01638B	20	60	1,8	26,00	74,00	16,00	10,1
22-10	F01650B	22	66	2,0	28,60	81,40	19,00	12,3
26-10	F01660B	26	78	2,3	33,80	96,20	26,50	17,1
New 32-10	F01670B	32	96	2,9	41,60	118,40	40,00	23,0

Coated with environmentally friendly AQUA-chain lacquer (RAL 5002).





Grade 100 Lashing Chains and Components

Chain Tensioners

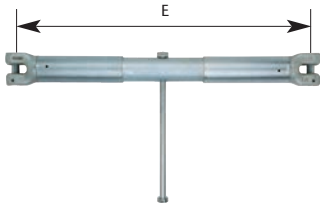

The Chain Tensioner with Spindle TWN 1454

is designed in accordance to standard EN 12195-3 and EN1677-1. In combination with other lashing and connecting components, it is mainly used in lashing chains for the securing of loads in all industry sectors. Additionally, it is suitable for overhead lifting purposes.

The tensioners achieve a high pre-tension force with less effort because of the screw transmission. This feature is important for tying down, because only the pretension force contributes to the securing of loads.

Trade Size	Article-No.	Norm. straight load (S_{TF}) [daN min.]	Tensioner under straight load [daN max.]	Dimensions [mm]			Weight approx. [kgs]
				E_{max}	E_{min}	Hub	
13-10	F341877	2.600	13.000	675	445	230	7,20
16-10	F341977	3.100	20.000	834	554	280	11,80

Note: Also suitable for lifting.

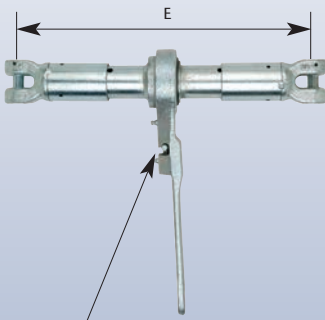

The Chain Tensioner with Ratchet TWN 1455

is designed in accordance with standard EN 12195-3 and EN1677-1. Together with other lashing and connecting components, they are mainly used in lashing chains for the securing of loads in all industry sectors. Additionally, they are suitable for overhead lifting purposes.

The ratchet tensioners achieve a high pre-tension force with less effort because of the screw transmission. This feature is important for tying down because only the pretension force contributes to the securing of loads.

Note: The life time of the chain tensioner with ratchet may be considerably extended by regular lubrication at the greasing nipple.

Trade Size	Article-No.	Norm. straight load (S_{TF}) [daN min.]	Tensioner under straight load [daN max.]	Dimensions [mm]			Weight approx. [kgs]
				E_{max}	E_{min}	Hub	
13-10	F341878	2.600	13.000	675	445	230	8,40
16-10	F341978	3.100	20.000	834	554	280	13,50

Note: Also suitable for lifting.

Grade 100 Lashing Chains and Components

Hooks

The Clevis Sling Hook TWN 1840/1

with its heavy-duty forged safety latch and its clevis is designed to the corresponding trade size. The onforged measurement points and maximum admissible values allows an easy inspection of the hook-opening. The safety latch is protected by wear edges on the hook body. Additionally, the safety latch has a fixed position due to the forged seat at the tip of the hook. The special shape makes the THIELE-original unique.

100% magnetic crack-tested.

DGUV-approved.

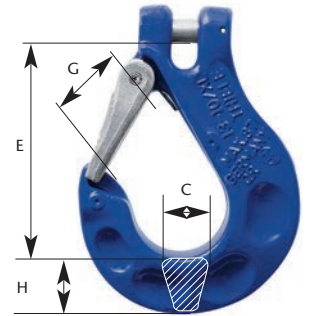

Trade Size	Article-No.	Working Load Limit [t max.]	Dimensions [mm]				Weight approx. [kgs]
			E	G	H	C	
6-10	F336050	1,40	75	24	20	17	0,36
8-10	F336150	2,50	92	30	25	22	0,75
10-10	F336250	4,00	113	37	32	28	1,40
13-10	F336350	6,70	133	42	41	35	2,50
16-10	F336450	10,00	162	51	50	41	4,40

Connectors

Connecting Link XL-LOK® TWN 1820

XL-LOK® connecting links according to THIELE plant standard (TWN) are designated for safe lifting, moving and slinging of weights. Working load limits and product requirements are based on the EN 1677-1, taking a 25% higher working load limit into account. Spare parts are available according to TWN 1921.

100% magnetic crack-tested.

DGUV-approved.

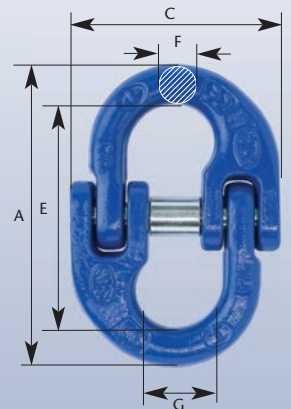

Trade Size	Article-No.	Working Load Limit [t max.]	Dimensions [mm]					Weight approx. [kgs]
			E	G	A	C	F	
6-10	F30807	1,40	45,0	14,0	61,0	38,5	7,6	0,07
8-10	F30817	2,50	62,0	19,0	85,0	55,0	10,0	0,20
10-10	F30827	4,00	72,0	23,8	97,2	65,5	12,6	0,35
13-10	F30837	6,70	87,3	28,0	125,3	82,5	16,7	0,74
16-10	F30847	10,00	105,0	34,3	146,2	109,0	20,6	1,16
New 22-10	F30861	19,00	140,0	47,3	193,0	132,5	26,0	3,30





Grade 100 Lashing Chains and Components

Shortening Components

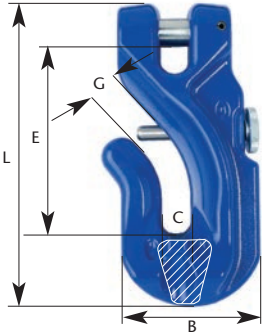

New

The **Clevis Shortening Hook TWN 1827/1 with Safety Pin** complies with DIN 5692 makes the lifting of loads safer due to a system inspection which means that the shortening hook fulfills the test requirements assembled into the chain. The new shape of the shortening hooks TWN 1827 offer you much more safety than with conventional shortening hooks. The extra wide chain attachment enables us to guarantee you an especially firm seating of the inserted chain link and it is also protected from damage at the same time. The locking pin prevents an accidental loosening of the sling chain. The special shape makes the THIELE-original unique.

With our new TWN 1827/1 shortening hook, we are offering you Grade 100 perfection combined with a long shelf life of your slinging equipment.

100% magnetic crack-tested.

DGUV-approved.

Trade Size	Article-No.	Working Load Limit [t max.]	Dimensions [mm]					Weight approx. [kgs]
			E	G	L	B	C	
6-10*	F33195	1,40	-	-	-	-	-	-
8-10	F33205	2,50	71	9,5	110	55	34	0,51
10-10	F33215	4,00	83	12,5	132	67	42	0,95
13-10	F33225	6,70	109	15,5	168	79	54	1,76
16-10*	F33235	10,00	-	-	-	-	-	-

*In development.

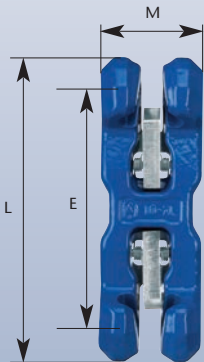

The **RAPID-Shortening Claw TWN 1852**

can be assembled and disassembled fast and easily with no additional tools. The ergonomic and compact design enables its positioning at any place on the chain. Two robust locking devices avoid the unsafe release of the chain in a loaded or unloaded condition. The locking device is equipped with a robust spring system.

100% magnetic crack-tested.

Trade Size	Article-No.	Working Load Limit [t max.]	Dimensions [mm]			Weight approx. [kgs]
			E	L	M	
8-10	F34775	2,5	111	148	48	0,79
10-10	F34780	4,0	134	180	60	1,97
13-10	F34785	6,7	179	240	78	2,70
16-10	F34790	10,0	222	296	96	9,00

Grade 100 Lashing Chains and Components

Lashing Points

Lashing Point with two Welding Brackets TWN 1473

The lashing points according to this TWN-works standard are designed for load securing of goods. They comply with the requirements of the DIN EN 12640. The production- and proof-requirements are based on the DIN EN 1677, part 1 and 4, taking a 25% higher lashing capacity into consideration.

The rings are marked with the lashing capacity (in LC) and show a tracability code. The safety factor is 1:2 related to the lashing capacity.

Finish: RAL 5002.

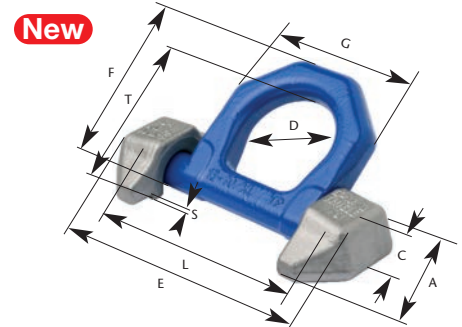

Lashing Capacity (LC) [daN]	Article-No.	Article-No. (Ring only)	Lashing Capacity (LC) [daN max.]	Dimensions [mm]									Weight app. [kgs]
				A	C	D	E	F	G	L	T	S	
10-10	F352001	F352002	8.000	65	28	48	134	74	74	105	70	2	0,79
13-10	F352011	F352012	13.500	80	37	60	170	93	100	135	85	2	1,70



Lashing Point „Compact“ with Spring TWN 1880

A perfect interplay of compactness and easy handling. The spring holds the D-link in its desired position. The small dimension of the TWN 1880 were the focus during the development process. A high lashing capacity and compact design makes our lashing point particularly remarkable.

The lashing point rotates 180°.

Finish: RAL 5002.



Trade Size	Article-No.	Lashing Capacity (LC) [daN max.]	Dimensions [mm]						Weight app. [kgs]
			D	B	A	E*	H	C	
6-10	F35204	3.000	14	38	65	42	25	49	0,42
8-10	F35205	5.000	15	45	76	45	27	50	0,57
10-10	F35206	8.000	17	50	85	57	31	55	1,66
13-10	F35207	13.500	23	68	116	79	44	77	2,20
16-10	F35208	20.000	27	69	130	72	54	92	3,35

*Upright standing ring.



Grade 100 Lashing Chains and Components

Lashing Points

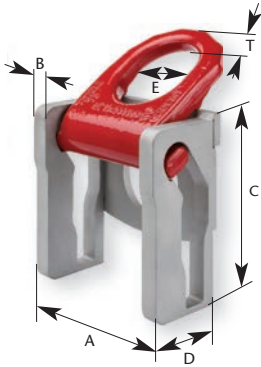

ZK-Module TWN 1471

The newly developed ZK-Module from THIELE is a lashing ring with cassette that can easily be adapted and attached to the side frames of trailers. These lashing rings are made of the same steel which is used in the manufacture of lashing chains.

The THIELE ZK-Module is approved by the German TÜV-inspection board and complies with the European standard DIN EN 12640.

It offers 100% lashing capacity and is capable of withstanding strain in all directions. The lashing point has a swivel range of 150°, enabling the secure lashing of low-load goods as well as goods that need protection beyond the load platform. Further on, the lashing ring is completely retractable, preventing accidents from happening when walking on the cargo area.

A new designed an patented slotted shape of the cassette enables a mechanical positioning of the lashing ring in pulling direction. Therefore the handling of lashing is considerably simplified for the operator.

Finish lashing ring: RAL 3003.

Legal protection of registered design: DE 20 2015 100 750.

Trade Size	Article-No.	Execution*	Lashing Capacity (LC) [daN max.]	Dimensions [mm]						Weight app. [kgs]
				A	B	C	D	E	T	
5	F352390	N	5.000	107	12	119	61	52	14	2,60
5 New	F352395	S	5.000	107	12	119	61	52	14	2,60
10	F352380	N	10.000	137	15	144	73	62	18	3,60
10 New	F352385	S	10.000	137	15	144	73	62	18	3,60

*The plates of the lashing cassette in the execution „N“ (=Normal) are produced in micro-alloyed steel. The execution „S“ (=Special) are produced from special steel and may be hot dip galvanized (up to 500°C), together with the vehicle frame.

The standard DIN EN 12640 specifies the minimum testing requirements for lashing points on road trucks and trailers with flat-bed bodies and a permissible total weight of more than 3,5 t that are meant for mixed cargo transportation. Lashing points are devices to which lashing devices may be directly fastened. A lashing point can be, for example, an oval link, hook, lug or lashing rail. This type of lashing points in practice are very often leading to problems.

A non-appropriate dimensioning and use of non-suitable lashing points, as well as the damage of the lashing point and frame of the vehicle, shows a high potential danger for traffic. During application oval links are often exposed to unforeseen torque which may cause a damage to the body-work of the vehicle (see picture). Very often requested inclination angles are not properly considered. Further if not in use oval links can cause unnecessary noise exposure in traffic. The new developed THIELE ZK-module (lashing ring with cassette) may be easily fitted and adopted at the side frame of the trailer.



Lashing Ring

The lashing ring is marked with permissible lashing capacity (LC), manufacturer name (THIELE) and DIN EN standard number (DIN EN 12640), so that official agencies are able to check its correct installation. The ZK-module made by THIELE provides highest safety for load securing and in the heavy-duty road traffic.



Grade 100 Lashing Chains and Components

Lashing Points

ZK-Module TWN 1471

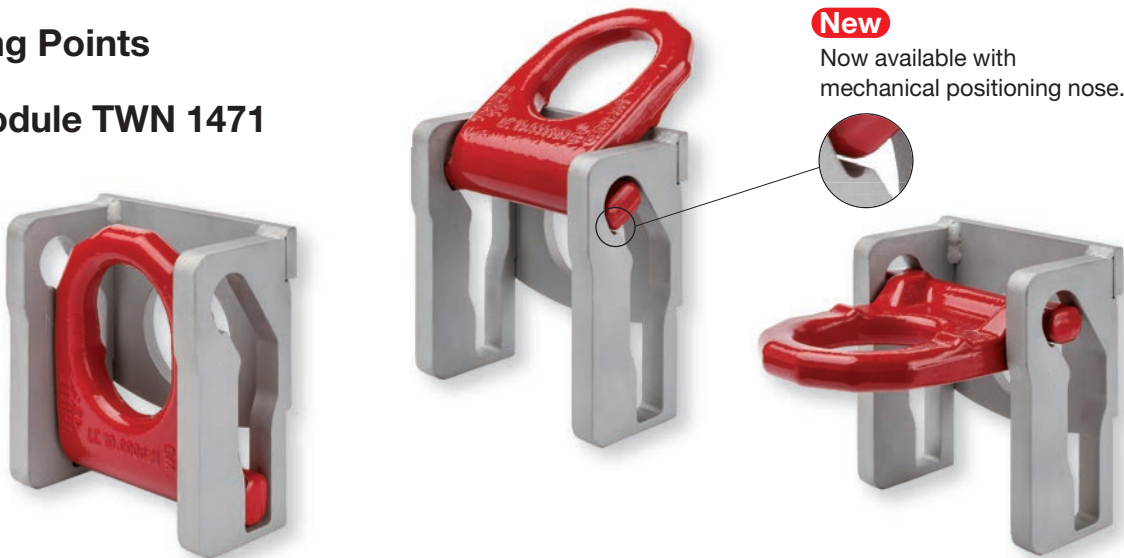

New

Now available with mechanical positioning nose.

New

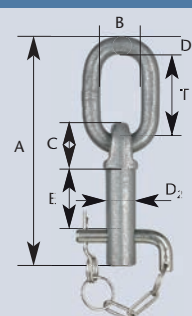
Lashing Capacity (LC) [daN max.]	Article-No.	Dimensions [mm]								Weight app. [kgs]	TWN 1474
		A	B	C	D ₁	D ₂	E	F	T		
8.000	F352255	197	35	41	16	26	51	45	70	1,0	 <p>Lashing Point, plugable with Intermediate Link</p>

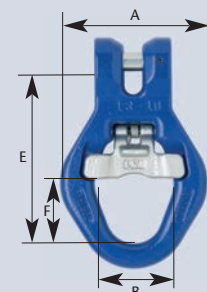

Special Sling Components

Trade Size	Article-No.	Working Load Limit [t max.]	Dimensions [mm]				Weight app. [kgs]	TWN 1869
			E	F	B	A		
13-10	F313805	6,70	142	57,5	65	122	1,92	 <p>Skip Suspension Link for one-hand use with Pin Coupling and forged Safety Latch</p>

New



Tensioners

TM Lever Block TWN 1001



Advantages for your Application:

- + With overload protection¹⁾
- + Lightweight robust steel construction
- + Super strength THIELE alloy load chain as per EN818-7, galvanized
- + Minimum headroom
- + Minimum effort to raise maximum load by easy handling
- + Hooks with strong cast steel safety latches
- + Lower hook easy turnable with roller bearing
- + Also approved for tensioning as per EN 12195
- + Protected automatic weston brake with unique twin pawls
- + Durable baked enamel paint protection
- + Spare parts available
- + TÜV / GS / CE approved
- + Supplied with THIELE test certificates
- + Manuals available in 5 languages



TM Ratchet Tensioner

¹⁾Except TM-LB 025

	Unit	TM-LB 025 ²⁾	TM-LB-OP 075N	TM-LB-OP 150N	TM-LB-OP 300N	TM-LB-OP 600N
Working Load Limit (Lashing Capacity)	[t max.]	0,25	0,75	1,5	3,0	6,0
Lift app. 1,50 m	[Article-No.]	F061901	F062411	F062511	F062611	F062711
Lift app. 3,05 m	[Article-No.]	F061902	F062412	F062512	F062612	F062712
Lift app. 4,60 m	[Article-No.]	F061903	F062413	F062513	F062613	F062713
Lift app. 6,10 m	[Article-No.]	F061904	F062414	F062514	F062614	F062714
Falls of chain	[pieces]	1	1	1	1	2
Effort to lift for max. Working Load	[kgs]	2,5	14	22	32	34
Loadchain diameter	[mm]	4	6	8	10	10
Length of lever handle (D)	[mm]	160	280	410	410	410
Headroom (A)	[mm]	230	325	380	480	620
Width (B)	[mm]	85	136	160	180	235
Depth (C)	[mm]	92	148	172	200	200
Hook-opening (upper)	[mm]	25	42	46	54	62
Hook-opening (lower)	[mm]	25	42	46	54	62
Net weight	[kgs]	1,8	7	11	21	31

²⁾Without overload protection.



THIELE Conveyor Chains

for Poultry Industry



Conveyor Chains for Poultry Industry

The round steel chain has for many years been the central means of propulsion in the poultry processing industry, and especially for slaughterhouse operations. Here round steel chains are employed on all manner of production lines, including slaughtering, dissection, weighing and chilling.

Round Steel Chains in Alloyed Steel TWN 0085

Round steel chains 8 x 25.4 mm in size are offered in standard lengths of 50 m. THIELE provides a connecting link with a grub screw for connecting together these standard chain lengths.

Dimension [mm]	Article-No.	Pitch p [mm]	Pitch tol. ± [mm]	Inner Width w ₁ [mm min.]	Outside Width w ₂ [mm max.]	Multi Pitch Length 11 x p [mm]	Multi Pitch Length tol. ± [mm]	Weight app. [kgs/m]
8 x 25,3	F05470	25,3	-0,1/+0,3	9,4	26,0	278,3	-0,0/+1,0	1,4
8 x 25,4	F05471	25,4	-0,2/+0,3	9,0	26,1	279,4	-0,4/+0,6	1,4
8 x 38,0	F05472	38,0	-0,2/+0,5	13,3	30,0	418,0	-0,0/+1,1	1,2
10 x 38,0	F05473	38,0	-0,2/+0,5	12,5	34,0	418,0	-0,5/+1,4	2,0

Technical Properties:

Description	Nominal Size [mm]	Test Force [kN min.]	Breaking Force [kN min.]	Surface Hardness [HV10]	Hardening Depth at HV 550 [mm]	Surface Thickness [μm min.]	Feature
T50E	8x25,3	22	37	min. 750	min. 0,5	25	S
T50E	8x25,4	24	40	720-800	0,6-1,0	12	S, M, F, L
T80E	8x38,0	22	40	750-850	0,12±0,01	12	
T50E	10x38,0	38	64	720-800	0,6-1,0	12	
T80E	10x38,0	60	98	720-800	0,6-1,0	12	
T50V	8x25,4	24	40	min. 250	-	-	

Material: Manganese steel, chromium-nickel-steel



Conveyor Chains for Poultry Industry

Round Steel Chains in Corrosion-resistant, Austenitic Steel

The round link chains made out of austenitic steel are fine-toleranced and offered in standard lengths of 50 m.

Dimension [mm]	Article-No.	Nominal Size d [mm]	Pitch p [mm]	Inner Width w ₁ [mm min.]	Outside Width w ₂ [mm max.]	Multi Pitch Length 11 x p [mm]	Multi Pitch Length tol. ± [mm]	Weight app. [kgs/m]
8 x 25,4	F054711	25,4	-0,2/+0,3	9,0	26,1	279,4	-0,4/+0,6	1,32

Technical Properties:

Description	Dimension [mm]	Test Force [kN min.]	Breaking Force [kN min.]
T60R	8x25,4	37,5	60

Material: Grade 1.4404 (or similar) corrosion-resistant austenitic steel



Chain Connecting Link TWN 0086

The connecting link with stud screw is a specially developed joint link for the round link chain 8 x 25,4 mm acc. to TWN 0085 and is electro galvanized.



Dimension [mm]	Article-No.	Pitch p [mm]	Inner Width w ₁ [mm min.]	Outside Width w ₂ [mm max.]	Breaking Force [kN min.]	Surface Hardness [HV10]	Hardening Depth at HV 550 [mm]	Weight app. [kgs]
8 x 25,4	F42077	25,4	9,3	26,1	30	550-600	0,2-0,3	0,04

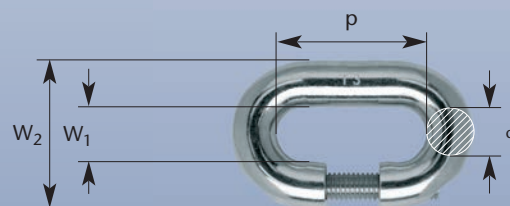



Conveyor Chains for Poultry Industry

The two key factors that affect the service life of round steel chains are wear and corrosion. This is why THIELE fine-toleranced round steel chains are manufactured with a high dimensional accuracy over a defined measuring distance.

Dimensional accuracy plays a decisive role and has a major impact on the operating life of the chain. Another important factor in ensuring a frictionless operation between the chain and the drive and take-up wheels is to use components that are a dimensional match for one another.

THIELE uses a specific case hardening process to minimise wear on its round steel chains. This process applies carbon diffusion into the surface of the material in order to render the chains wear resistant.

Case Hardened Round Steel Chain 8x25,4 mm

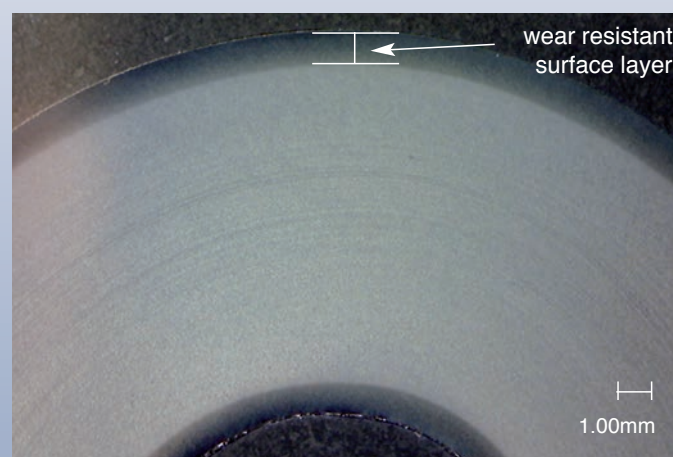

Round steel chains operating in slaughterhouse lines are exposed to chemical influences, such as cleaning agents, and therefore under constant corrosion attack. Alloy steel chains of this kind are provided with a galvanic coating to counteract the effect of corrosion. The professionally applied, galvanic surface sealing that THIELE has been employing for many years effectively counteracts premature corrosion.



Conveyor Chains for Poultry Industry

Wear

In operation, round link chains are exposed to wear at interlink.

The interlink wear causes at pitch elongation of the chain link and therefore also of the conveyor chain.

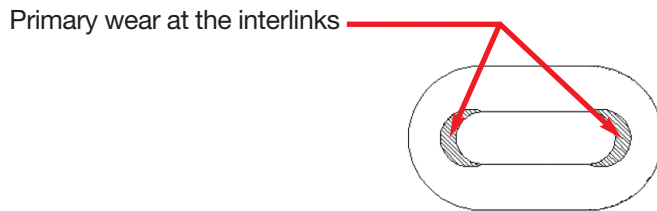

For this reason, THIELE conveyor chains are produced with a corresponding surface hardness and hardening depth, therefore the operational wear is counteracted.

Discard criteria

Any frictional process of this kind will inevitably result in material loss, especially in the interlink areas. As a manufacturer we recommend to take a round steel chain out of operation when the amount of elongation over defined meaning measuring length is greater than 2%.

The Definition of the discard criteria is calculated with the below formular, taking a measuring length of over a length of 11 chain pitches into consideration:

$$\text{READY FOR DISCARD} = M_E > 2\% M_L$$

The meaning of formular symbols:

M_E = test section of the chain in current use

M_L = test section of original length

Continuing to use the chain beyond this limitation usually results in excessive wear to the chain and chain wheels. It can also cause functional failures that can lead to costly production downtimes.





Conveyor Chains for Poultry Industry

The requirements imposed on the fracture mechanics of round steel chains are derived from the process parameters. Here it is essentially the speed and load conditions, under consideration of the coefficients of friction and deflection, that determine the breaking-strength requirements of the chain.

THIELE can provide a range of material grades and heat treatments for individual applications. These must be precisely coordinated in advance with the equipment manufacturer or plant operator on a case-by-case basis.

THIELE can draw on decades of experience in the manufacture and application of round steel chains for poultry slaughter plants.

THIELE round steel chains therefore constitute the central drive transmission element in poultry processing plants.

THIELE Conveyor Chain – The central element in the Drive Transmission System.





THIELE

Conveyor Chains for Farming



Conveyor Chains for Farming

Round Steel Chains for Agricultural Trailers and Dung Spreaders.

Special round steel chains, according to TWN 5100, are mainly used on agricultural trailers, dung spreaders and other agricultural equipments.

Dimension	Article-No.	Operating Force [kN max.]	Proof Force [kN min.]	Breaking Force [kN min.]	Measuring Length (11 x p)		Weight app. [kgs/m]	TWN 5100
					[mm]	zul. Abw.		
8 x 22,8	F05011	18	45	63	250,8	+1,1	-0,6	1,40
8 x 24	F05031	18	45	63	264,0	+1,2	-0,6	1,35
8 x 28	F05062	18	45	63	308,0	+1,4	-0,7	1,30
8 x 31	F05051	18	45	63	341,0	+1,5	-0,8	1,30
9 x 27 ¹⁾	F05072	22,4	56	80	297,0	+1,3	-0,7	1,80
9 x 31 ¹⁾	F05081	22,4	56	80	341,0	+1,5	-0,8	1,60
9,5 x 27 ¹⁾	F05121	25	63	90	297,0	+1,3	-0,7	1,80
10 x 26,5 ¹⁾	F05151	28	71	100	291,5	+1,3	-0,7	2,30
10 x 28	F05155	28	71	100	308,0	+1,4	-0,7	2,30
10 x 30,5	F05171	28	71	100	335,5	+1,5	-0,8	2,20
10 x 31	F05181	28	71	100	341,0	+1,5	-0,8	2,20
10 x 35	F05195	28	71	100	385,0	+1,7	-0,9	2,05
10 x 38 ¹⁾	F05201	28	71	100	418,0	+1,9	-1,0	2,02
11 x 31	F05221	33,5	85	120	341,0	+1,5	-0,8	2,70
11 x 35	F05230	33,5	85	120	385,0	+1,7	-0,9	2,60
12 x 36	F05251	40	100	140	396,0	+1,8	-0,9	3,20
12 x 42	F05261	40	100	140	462,0	+2,1	-1,1	2,90
13 x 36	F05285	47,5	118	190	396,0	+1,8	-0,9	3,80
13 x 45 ¹⁾	F05291	47,5	118	190	495,0	+2,2	-1,1	3,45
13,2 x 62 ¹⁾	F05302	47,5	118	190	682,0	+3,1	-1,6	3,10
14 x 42	F05331	53	132	190	462,0	+2,1	-1,1	4,30
16 x 56 ¹⁾	F05355	71	180	250	616,0	+2,8	-1,4	5,40



Special Round Steel Chain in Special Grade

Note: ¹⁾Bright polished finish.

The length tolerance of chain strands for each strand is +0,3 / -0,0 %.

The length tolerance of matched pair chain strand is 0,1%.



For the measurement of the length of matched pair chain strands, each chain strand must be free of torsion and strained or hanged with 1% of the corresponding breaking force.

Dimension	Grade	Article-No.	Breaking Force [kN min.]	Weight app. [kgs/m]	
14x50 ²⁾	1	F13107	194	3,90	 <p>Special Chain for Dung Spreaders and Trailers</p>
14x50 ²⁾	2	F13101	246	4,00	

Note: ²⁾Bright polished finish.



Conveyor Chains for Farming

Dimension	Article-No.	Breaking Force [kN min.]	Weight app. [kgs]	TWN 5200
8x24/8x22,8	F05500 ¹⁾	70	0,066	 <p>Typ VGG</p>  <p>Typ VG</p> <p>Special Connecting Link</p>
8x31/9x31	F05510 ¹⁾	85	0,079	
8x28	–	85	0,079	
9,5x27/10x26	F05531 ¹⁾	90	0,095	
10x28	F05541 ¹⁾	100	0,100	
10x30,5	F05550 ¹⁾	100	0,114	
10x31/11x31	F05550 ¹⁾	100	0,114	
8x31	F05520 ²⁾ (VGG)	85	0,079	
10x31	F05551 ²⁾	100	0,114	
10x35	F05555 ¹⁾	100	0,100	
10x38 ³⁾	F05560 ¹⁾	100	–	
11x35	F05556 ²⁾	100	0,130	
11x35	F05564 ¹⁾	100	0,100	
12x36	F05574 ¹⁾	140	–	
12x42	F05573 ²⁾	140	–	
13x36	F05570 ¹⁾	170	–	
13x45 ³⁾	F05575 ¹⁾	170	0,255	
14x42	F05568 ¹⁾	190	–	

Note: ¹⁾Bright polished finish, ²⁾Electro galvanized finish, ³⁾Upon request.
Min. order quantity: 30 pieces.

Dimension	Article-No.	Breaking Force [kN min.]	Weight app. [kgs]	TWN 0111
14x50	F25006	212	0,675	 <p>Chain Connector as per DIN 22253</p>

Note: With screw M16 x 65 as per DIN 931 ST 8.8 and nut as per DIN 985-1610, suitable for chain as per DIN 22252.







Conveyor Chains for Farming

Dimension	Article-No.	Type	Weight app. [kgs]	TWN 5201
8x24/8x22,8	Z03598	MF8x22,8/24	0,016	 <p>Special Flange</p>
8x31	Z03599	MF8x31	0,045	
9,5x27	Z03600	MF9,5x27	0,046	
10x31	Z03602	MF10x31	0,062	
10x38	Z03603	MF10x38	0,062	

Note: Min. order quantity: 50 pcs.

Dimension	Article-No.	Type	Weight app. [kgs]	TWN 5202
8x24/8x22,8	Z03868	HK 8	0,015	 <p>Special Hammer Head Screw</p>
9,5x27	Z03870	HK 9,5x27	0,022	
10x31	Z03871	HK 1010	0,035	

Note: Min. order quantity: 50 pcs.

Dimension	Article-No.	Type	Weight app. [kgs]	TWN 5204
9x31	Z03584	58 B04	2,90	 <p>Special Drive Pocketwheel</p>





THIELE Chain Sprockets



Chain Sprockets

THIELE pocket wheels constitute the perfect solution when it comes to creating an efficient drive system.

Chain wheels and system components are widely used in the light materials handling industry. The integration of Richard Hippenstiehl Maschinenbau into the THIELE business group has enabled THIELE to expand its range of products and broaden its existing expertise in drive and conveying technology.

THIELE's fully modernised plant and equipment pool is now able to supply a wide range of components, including shafts, V-belt pulleys, one-piece and multi-piece chain sprockets and pocket wheels for drive and return systems.

THIELE pocket wheels and system components operate with round steel chains to provide a perfectly matched solutions for all kinds of applications.

The round steel chain is a durable and solid example of engineering that outperforms the bushed chain, the steel link chain and the fork link chain as a drive medium.

THIELE can now draw on years of experience in the manufacture, development and application of drive and return sprockets and has already produced system solutions for a whole portfolio of technically challenging situations.

The company has manufacturing facilities capable of producing components measuring 50 to 1.000 mm in diameter and 50 to 3.500 mm in length.

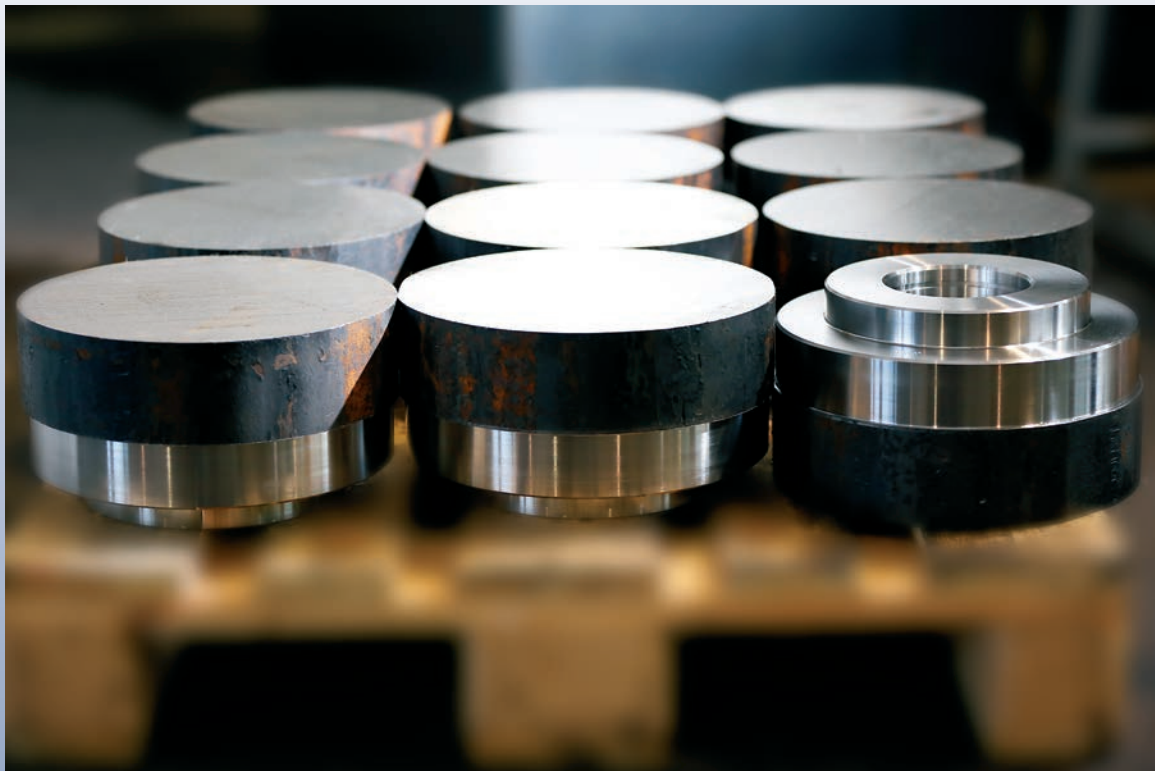



Chain Sprockets

As the chain pocket is in multiple contact with each chain link partially inductive contour hardening is applied at the manufacturing stage in order to increase the wear-resistant properties of the pockets.

Generally speaking:

The greater the number of teeth or chain pockets, the more silent-running is the chain and consequently the lower the rate of wear and the less the degree of imbalance (polygon effect).

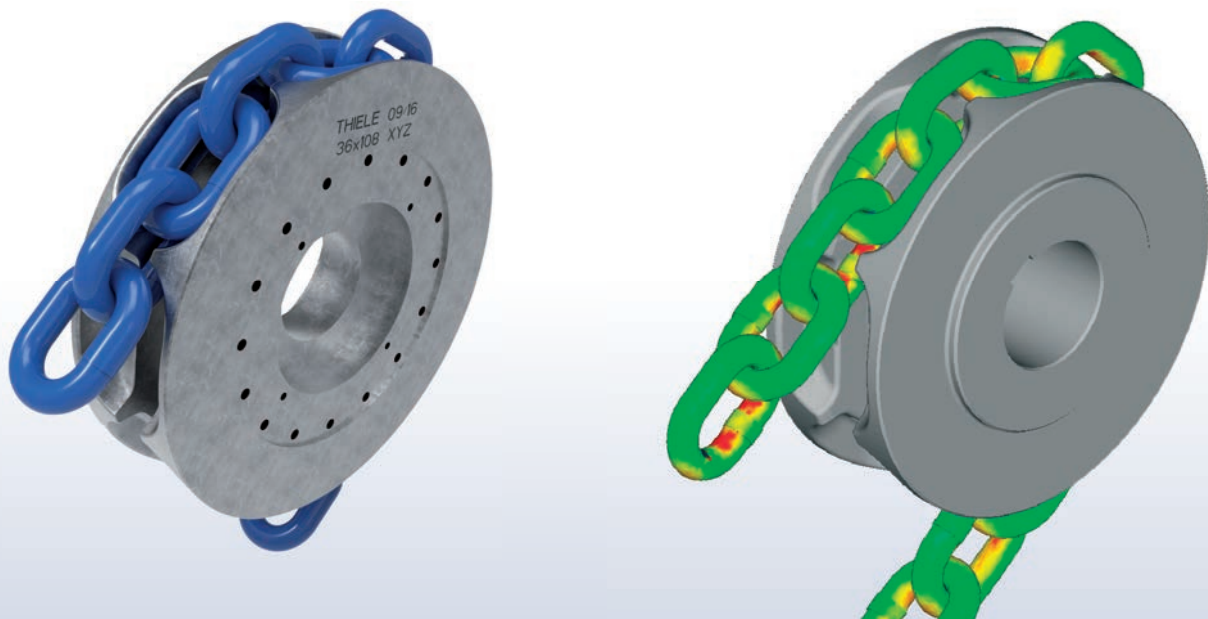

Identification:

Each pocket wheel is marked with the manufacturer's symbol „THIELE“, the date of manufacture, the nominal size of the round steel chains and a traceability code.

The latest FEM technology is used in the upstream design process in order to simulate the low-friction running behaviour generated between the round steel chains and the load-optimised pocket wheels.

Pocket wheels for bulk-materials conveyors and lifting equipment are manufactured from high-alloy stainless steel and feature partial inductive hardening.

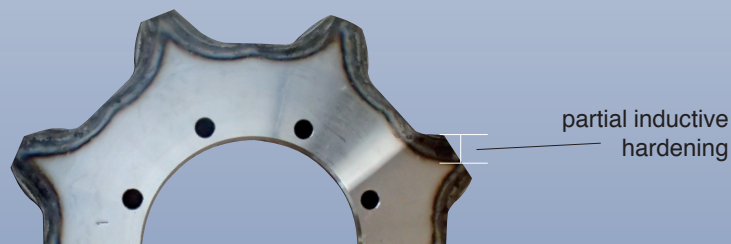

The choice of feedstock essentially depends on the intended application and THIELE is able to select from a range of materials from C45 through to manganese and chromium alloyed, heat treated steel of type 42CrMo4.



Chain Sprockets

One-piece Pocket Wheels

Dimension [mm]	No. of Pockets [i]	Outer Diameter [mm max.]	Pitch Circle Diameter [mm min.]	
18x50	8	275	256,9	 One-piece pocket wheel
20x60	8	325	308,2	
22x66	8	360	339,0	
26x78	7	375	351,5	

Note: The dimensions are exemplary. Execution upon specification.
Hub-diameter and depth upon request.

Dimension [mm]	No. of Pockets [i]	Outer Diameter. [mm max.]	Pitch Circle Diameter. [mm min.]	
28x84	8	454	431,5	 One-piece pocket wheel
39x90	7	440	405,8	
32x96	8	520	493,4	
36x108	8	588	533,6	
40x120	8	650	615,5	
45x135	8	738	693,3	

Note: The dimensions are exemplary. Execution upon specification.
Hub-diameter and depth upon request.

For inquiries, please provide following data:

- specific application
- chain size
- chain specification
- number of pockets
- pitch diameter
- hub diameter
- hub depth
- method of fixing the pocket wheel to the shaft, e.g. keyway and key

Thanks to the latest 3D-programs any chain wheel or system component can now be supplied tailor-made to the customer's requirements.

As well as producing sprockets for industrial uses we also manufacture special chain wheels for practically every application that uses drive systems of this kind.

THIELE chain wheels can be machined from solid billet or produced as welded assemblies.

The design and manufacturing process will essentially depend on what the individual customer has specified for the number of teeth, hub diameter and key/keyway drilling.

This means that THIELE can supply any desired size of drive and return sprocket for every kind of lifting and conveying system.



THIELE Stainless Steel Chains





Rust & Acid Resistant Chains

Material 1.4401 / AISI 316

Dimension	Article-No.	Plant Standard	W.L.L. [kg max.]	Test Force [kN min.]	Breaking Force [kN min.]	Standard	Nominal Size		Pitch		Width		Weight app. [kgs/m]
							d [mm]	Tol.± [mm]	p [mm]	Tol.± [mm]	b ₁ [mm min.]	b ₂ [mm max.]	
2x12	Z02607	0084	–	–	–	DIN 5685 ¹⁾	2	0,10	12	+0,6 / -0,6	3,6	–	0,07
2x22	Z02587	0084	–	–	–	DIN 5685 ¹⁾	2	0,10	22	+1,1 / -1,1	3,6	–	0,06
3x16	Z02658	0084	–	–	–	DIN 5685 ¹⁾	3	0,15	16	+0,8 / -0,8	5,4	–	0,16
3x26	Z02485	0084	–	–	–	DIN 5685 ¹⁾	3	0,15	26	+1,3 / -1,3	5,4	–	0,14
4x16	Z02604	0083	200	5	8	DIN 766	4	0,20	16	+0,3 / -0,2	4,8	13,6	0,31
4x19	Z02634	0084	–	–	–	DIN 5685 ¹⁾	4	0,20	19	+1,0 / -1,0	7,2	–	0,30
4x32	Z02824	T0082	100	2,5	6	DIN 763 ¹⁾	4	0,20	32	+1,0 / -1,0	7,2	16,8	0,26
5x18,5	Z02484	0083	320	8	13	DIN 766	5	0,20	18,5	+0,4 / -0,2	6,0	17,0	0,51
5x21	Z02743	0084	–	–	–	DIN 5685 ¹⁾	5	0,25	21	+1,1 / -1,1	9,0	–	0,48
5x35	Z02515	0082	160	4	10	DIN 763 ¹⁾	5	0,25	35	+1,1 / -1,1	9,0	21,0	0,41
6x18,5	Z02633	0083	400	10	16	DIN 766	6	0,20	18,5	+0,4 / -0,2	7,2	20,4	0,79
6x42	Z02593	0082	200	5	12,5	DIN 763 ¹⁾	6	0,20	42	+1,3 / -1,3	10,8	25,2	0,59
7x22	Z02710	0083	630	16	25	DIN 766	7	0,30	22	+0,4 / -0,2	8,4	23,8	1,06
8x24	Z02483	0083	800	20	32	DIN 766	8	0,30	24	+0,4 / -0,2	9,6	27,2	1,41
8x52	Z02530	0082	400	10	25	DIN 763 ¹⁾	8	0,30	52	+1,6 / -1,6	14,4	33,6	1,08
10x28	Z02548	0083	1250	32	50	DIN 766	10	0,40	28	+0,5 / -0,3	12,0	36,0	2,28
13x36	Z02662	0083	2000	50	80	DIN 766	13	0,50	36	+0,6 / -0,3	15,6	47,0	3,87
13x82	Z02631	0082	1000	25	63	DIN 763 ¹⁾	13	0,50	82	+2,5 / -2,5	23,4	54,6	2,95
16x45	Z02711	0083	3200	40	128	DIN 766	16	0,60	45	+0,8 / -0,4	19,2	58,0	2,87

Material 1.4571 / AISI 316Ti

Dimension	Article-No.	Plant Standard	W.L.L. [kg max.]	Test Force [kN min.]	Breaking Force [kN min.]	Standard	Nominal Size		Pitch		Width		Weight app. [kgs/m]
							d [mm]	Tol.± [mm]	p [mm]	Tol.± [mm]	b ₁ [mm min.]	b ₂ [mm max.]	
5x18,5	F00050	0083	320	8	13	DIN 766	5	0,20	18,5	+0,4 / -0,2	6,0	17,0	0,51
6x18,5	F00075	0083	400	10	16	DIN 766	6	0,20	18,5	+0,4 / -0,2	7,2	20,4	0,79
7x22	F000791	0083	630	16	25	DIN 766	7	0,30	22	+0,4 / -0,2	8,4	23,8	1,06
8x24	F00163	0083	800	20	32	DIN 766	8	0,30	24	+0,4 / -0,2	9,6	27,2	1,41
10x28	F00285	0083	1250	32	50	DIN 766	10	0,40	28	+0,5 / -0,3	12,0	36,0	2,28
10x65	F01138	0082	630	16	25	DIN 763 ¹⁾	10	0,50	65	+2,0 / -2,0	18,0	42,0	1,68
13x36	F00385	0083	2000	50	80	DIN 766	13	0,50	36	+0,6 / -0,3	15,6	47,0	3,87
13x82	F01154	0082	1000	25	40	DIN 763 ¹⁾	13	0,50	82	+2,5 / -2,5	23,4	54,6	2,87
16x45	F00485	0083	3200	80	128	DIN 766	16	0,60	45	+0,8 / -0,4	19,2	58,0	5,82

Material 1.4462 (Duplex)

Dimension	Article-No.	Plant Standard	W.L.L. [kg max.]	Test Force [kN min.]	Breaking Force [kN min.]	Standard	Nominal Size		Pitch		Width		Weight app. [kgs/m]
							d [mm]	Tol.± [mm]	p [mm]	Tol.± [mm]	b ₁ [mm min.]	b ₂ [mm max.]	
5x18,5	F00077	0083	560	14	22	DIN 766	5	0,20	18,5	+0,4 / -0,2	6,0	17,0	0,51
6x18,5	F00079	0083	800	20	32	DIN 766	6	0,20	18,5	+0,4 / -0,2	7,2	20,4	0,79
7x22	F00080	0083	1100	28	44	DIN 766	7	0,30	22	+0,4 / -0,2	8,4	23,8	1,06
8x24	F00165	0083	1400	35	55	DIN 766	8	0,30	24	+0,4 / -0,2	9,6	27,2	1,41
10x28	F00284	0083	2200	54	87	DIN 766	10	0,40	28	+0,5 / -0,3	12,0	36,0	2,28
10x65	F01144	0082	1200	30	48	DIN 763 ¹⁾	10	0,50	65	+2,0 / -2,0	18,0	42,0	1,68
13x36	F00388	0083	3800	95	150	DIN 766	13	0,50	36	+0,6 / -0,3	15,6	47,0	3,87
13x82	F01145	0082	2000	50	80	DIN 763 ¹⁾	13	0,50	82	+2,5 / -2,5	23,4	54,6	2,87
16x45	F004651	0083	5800	145	230	DIN 766	16	0,60	45	+0,8 / -0,4	19,2	58,0	5,82

¹⁾Do not use for lifting or carrying purposes and not as chain slings!



Rust & Acid Resistant Chains

Rust & Acid Resistant Chains are mostly used at environmental processes with corrosive or aggressive influences, which may be found e.g. in the chemical industry, food industry, medical and pharmaceutical industry and ship building and shipping industry. Due to their high value finish, they are also used in architecture applications.

The materials 1.4401 (V4A), 1.4571 (V4A) and 1.4462 (DUPLEX) distinguish themselves through their corrosion resistance and mechanical qualities. The material 1.4571 differs to material 1.4401, due to the addition of titan through a higher resistance against intergranular corrosion (EN10088-3, Tab. 10). The corrosion resistance is classified by the PRE number (Pitting Resistance Equivalent) as per standard VG81249.

The tables below show that the material DUPLEX is especially marking off for a high resistance in sea water. In particular, the higher resistance in environments with high chlorinate-ions concentrations and higher temperatures are marking off, which one can find e.g. in the Southern Sea or Mediterranean areas. The higher strength up to 30%, at the same time has the advantage of lower weight, when selecting chains. Consequently, this material has an outstanding capability for all purposes especially as anchor chains (better distribution in the chain box) or for conveying systems (better gliding).

Material	PRE No.
1.4401	23,10 – 26,75
1.4571	23,10 – 28,50
DUPLEX	30,85 – 38,07

Note: as per VG 81249

PRE No.	Highest temperature for resistance in salt water
35	60° C
30	40° C
24	25° C
20	15° C
15	0° C





THIELE Fishing Chains







Fishing Chains

Field of Application

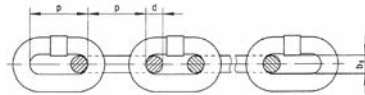
Non twisting round steel chains of this works standard are used for all areas of commercial fishing. The geometrical dimensions match the corresponding type of trawl nets.



Dimension Chain [mm]	Type	Article-No.	Diameter		Pitch		Inside width		Breaking Force [kN min.]	Weight app. [kgs]	 Fishing Chain
			d [mm]	tol. ± [mm]	p [mm]	tol. ± [mm]	b ₁ [mm min.]	[mm max.]			
10 x 40	ML	F02881	10	0,4	40	1,2	40	1,2	126	2	
13 x 55	ML	F02877	13	0,5	55	1,7	55	1,7	214	3,3	
13 x 81	LL	F02873	13	0,5	81	2,4	81	2,4	214	2,9	
16 x 64	ML	F02875	16	0,6	64	1,9	64	1,9	322	5,1	
16 x 100	LL	F02876	16	0,6	100	3,0	100	3,0	322	4,4	
19 x 76	ML	F02872	19	1,0	76	2,3	76	2,3	454	7,1	
19 x 100	LL	F02874	19	1,0	100	3,0	100	3,0	454	6,5	
22 x 88	ML	F02878	22	1,1	88	2,6	88	2,6	610	9,6	
22 x 110	LL	F02871	22	1,1	110	3,3	110	3,3	610	8,8	
26 x 140	LL	F02891	26	1,3	140	4,2	140	4,2	850	12	
28 x 150	LL	F02879	28	1,4	150	4,5	150	4,5	986	14	

Type ML = mid link, Type LL = long link

Specification

- Material according to EN818-2
- Resistance: 1.100-1.255 N/mm²
- Elongation at break: Min. 15%
- Marking „KWS-8“, „Germany“ and traceability code
- Finish: black coloured (RAL 9005)
- Special chains such as scallop chains are available upon request

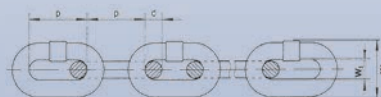

New

Dimension Chain [mm]	Type	Article-No.	Diameter		Pitch		Inside width	Outside width	Breaking Force* [kN min.]	Weight app. [kgs]	 Fishing Chain
			d [mm]	tol. ± [mm]	p [mm]	tol. ± [mm]	w ₁ [mm min.]	w ₂ [mm max.]			
16 x 48	SL	F014801	16	0,64	48	1,4	20,8	59,2	280	5,7	
17 x 48	SL	F02865	17	-0,14/-1,00	48	1,4	20,8	59,2	300	5,8	

Type SL = short link

*self coloured

Specification

- Application Temperature: -40°C bis +205°C
- Elongation at break: min. 20 %
- Notch impact KV = 35 J at -20°C
- Finish: hot dipped galvanized acc. to DIN EN ISO 1461-t Zn o



THIELE Inspection Service





Inspection Service

Regular inspection of work equipment

DGUV-R 500, Section 2.8, round steel chains, lifting equipment, and load suspension equipments are subject to mandatory inspections.

Part. 1 of the German Occupational Health and Safety Act and Part. 3 of the Operational Safety Act specify that the employer is responsible according to his risk assessment to take the necessary measures for the safe provision and use of the work equipment.

In Part. 4, Part. 10 and Part. 11 of the Operational Safety Act, these responsibilities are specified in more detail. The employers' liability insurance associations, on the other hand, provide recommendations as insurers for the safe operation of work equipment that can be used as standards in the event of an insurance claim.

We view our task is to be provide you the support in the planning and fulfillment of these requirements.

From the exact **analysis** of the current state and the **optimization** of the processes to the safe use of your equipment, we provide your company with support using our years of experience. We would be happy to completely take over parts of the areas you are responsible for and offer you **individualized maintenance** and **service contracts**.

Together with you, we will increase the level of safety in your company and ensure the economical and efficient use of your equipment over the long term.

Our customer services:

Load suspension and lifting equipment in lifting operations, DGUV-R 100-500, Section 2.8

Round steel chains, lifting chains, lifting beams, lifting equipment, textile ropes and straps, steel cables, lashing chains and belts, load securing devices

- **Visual inspections** and functional checks should be performed regularly at least once per year
- It is recommend to conduct **non-destructive crack checks** on round steel chains used for lifting at an interval of no longer than three years
- **Maintenance, repair**, and manufacture of new chain slings on-site with a test certificate
- Value preservation analysis and documentation, also in digital form

Winches, lifting, and tensioning devices DGUV 54

Mechanical winches of all type, metal grippers, clamps, ratchet hoists, cable hoists, magnets, ratchet lever hoists, etc.

- **Visual inspections and functional checks** up to a tensile force of **12t** and a pressure of **23t** on our portable test rigs
- Maintenance and servicing on-site, repairs upon request

Personal protection equipment, protection against falling, and rescues from heights, DGUV-R 112-198, DGUV-R 112-199

Harnesses, fastening equipment, hoisting cables, fall arresters, etc.

- **Visual inspections** and functional checks at least once per year
- **Expert examination** of PPE after a fall

Documentation, organization, prevention

- Management of records, inspection log books, repair reports, test certificates, etc. in written or even in digital form
- Reminder service for your inspection intervals
- Meetings before and after inspections to improve the efficiency and effectiveness of maintenance and service measures
- **We provide all services during all three shifts, on weekends, and on holidays.**
- **Drive-in service** in our factory in Iserlohn for trucking companies, construction companies, tradesmen, vehicles in use, or in especially urgent cases. When one half hour notice in advance is given or another appointment is agreed to, we will immediately inspect the work equipment delivered.

Consulting and Analysis

Give us a call. We would be pleased to make an appointment with you and advise you in aspects of our range of products and services, even at your company site.

Contact

Your contact is:
Mr. Frank Bollmann
Tel.: +49 2371/947-226
Fax: +49 2371/947-241
E-Mail: f.bollmann@thiele.de



THIELE Customer Engineering

Special Chains, System Solutions





Round Steel Link Chains

Round Steel Link Chains acc. to DIN 763

This standard is valid for tested non-calibrated long-link round steel chains.

Chains acc. to this standard are not allowed to be used as load suspension devices, lifting devices or suspension elements in the sense of DIN 15003.

Finish: self coloured, bright polished, electro galvanized, hot dipped galvanized finish.

Dimension [mm]	Working Load Limit [t max.]	Article-No. Finish				Weight app. [kgs/m]
		self col.	bright pol.	electro galv.	hot dipped galv.	
4x32	0,10	Z00013	F01013	F01011	F01019	0,27
5x35	0,16	F01032	F01035	F01038	F01041	0,43
6x42	0,20	Z00015	F01057	F01069	F01063	0,63
7x49	0,30	F01082	F01085	F01086	F01091	0,86
8x52	0,40	Z00019	F01107	F01110	F01113	1,10
10x65	0,63	F01126	F01129	F01134	F01135	1,75
13x82	1,00	Z02516	F01152	F01159	F01158	2,95
16x100	1,60	F01172	F01175	-	F01187	4,45

Note: 30m bundles.

Round Steel Link Chains acc. to DIN 766-3

This standard is valid for tested calibrated short link round steel chains in Grade 30.

Chains acc. to this standard are used in multiple areas of the industry.

The round steel chains are heat treated and comply with the safety-related requirements according to DIN 685 part 2.

Finish: self coloured, bright polished, electro galvanized, hot dipped galvanized finish.

Dimension [mm]	Working Load Limit [t max.]	Article-No. Finish				Weight app. [kgs/m]
		self col.	bright pol.	electro galv.	hot dipped galv.	
4x16	0,20	F00011	F00013	F00016	F00015	0,32
5x18,5	0,32	Z00114	F00042	F00038	F00039	0,50
6x18,5	0,40	F00055	F00059	F00061	F00062	0,80
7x22	0,63	F00089	F00092	F00095	F00093	1,10
8x24	0,80	F00131	F00134	F00137	F00136	1,40
9x27	1,00	F00184	F00178	F00181	F00199	1,80
10x28	1,25	F00273	F00258	F00261	F00260	2,30
11x31	1,60	F00306	F00300	F00303	F00321	2,70
13x36	2,00	F00395	F00380	F00383	F00376	3,90
16x45	3,20	F00460	F00463	F00466	F00464	5,80

Note: 50m bundles.



Special Steel Link Chains

THIELE also manufactures round steel chains made of special materials such as heat-resistant materials for the broadest range of applications.

Further on we also manufacture chains and accessories in accordance with numerous German and international standards and individual customer requirements.

Further Product Range:

- Suspension chains for mining and tunneling
- 2-wheel safety chains
- Heat resistant chains
- Sugar cane chains
- Non magnetic chains for marine boats

Please feel free to contact us to learn more and request an offer.

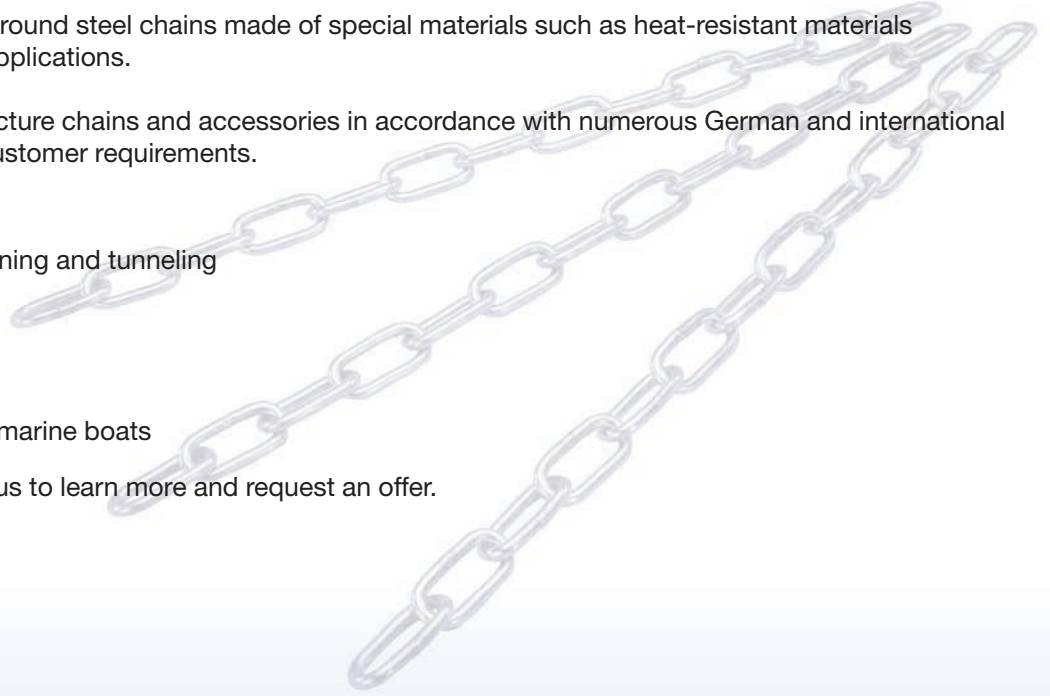



Index

Article	Grade	TWN No.	Page
Assembly Set	G100	TWN0945	45
Assembly Set	G80	TWN0945	103
Balancer	G80	TWN0882	92
Bolt Shackle Type C	G100	TWN1871	40
Bolt Shackle Type C	G80	TWN0870	87
Cargo Shackle	G80	TWN0898	88
Cargo Shackle with Bush	G80	TWN0898/1	88
Chain and Wire Rope Cutter		TWN0941	102
Chain Card File	G100	TWN0944	45
Chain Card File		TWN0944	103
Chain Connecting Link		TWN0086	193
Chain Connector as per DIN 22253		TWN0111	199
Chain Coupling Shackle with Bolt	G80	TWN0861	86
Chain Coupling Shackle with Safety Bolt, Nut and Cotter Pin	G80	TWN0862	86
Chain Gauge Set	G80	TWN0946	103
Chain Sprockets			201-204
Chain Tensioner (long hub)	G80	TWN1452	.89+178
Chain Tensioner with Ratchet	G100	TWN1455	.42+184
Chain Tensioner with Spindle	G100	TWN1454	.41+184
Clevis Foundry Hook	G80	TWN0859	82
Clevis Self-Locking Hook	G100	TWN1837	35
Clevis Self-Locking Hook	G80	TWN0799	79
Clevis Shortening Claw	G100	TWN1851	38
Clevis Shortening Claw	G80	TWN0851	85
Clevis Shortening Hook	G80	TWN0827	.85+179
Clevis Shortening Hook	G100	TWN1827	37
Clevis Shortening Hook with Safety Pin	G100	TWN1827/1	.38+186
Clevis Shortening Hook with Safety Pin	G80	TWN0827/1	.85+179
Clevis Sling Hook	G100	TWN1840/1	.36+185
Clevis Sling Hook with Safety Latch	G80	TWN1340/1	.79+179
Connecting Link XL-LOK®	G100	TWN1820	.34+185
Connector THI-LOK®	G80	TWN1320	.78+180
Container Centring Pivo	G80	TWN0869/1	91
Conveyor Chains for Poultry Industry		TWN0085	192
Excavator Hook	G80	TWN0850/2	131
Eye Foundry Hook	G100	TWN1856	37
Eye Foundry Hook	G80	TWN0856	81
Eye Self-Locking Hook	G100	TWN1836	35
Eye Self-Locking Hook	G80	TWN0798	79
Eye Sling Hook	G100	TWN1841/1	36
Eye Sling Hook	G80	TWN0855	81
Eye Sling Hook with Safety Latch	G80	TWN0855/1	81
Fine Tolerance Hoist Chains			143-151
Fishing Chains		TWN0081	210
Fixed Size Master Link Assembly TAA 1	G100	TWN1810/1	32
Fixed Size Master Link Assembly TAA 2	G100	TWN1810/2	32
Fixed Size Master Link Assembly TAA 4	G100	TWN1810/4	33
Fixed Size Master Link Assembly Type TAA 1	G80	TWN0810/1	73
Fixed Size Master Link Assembly Type TAA 2	G80	TWN0810/2	73
Fixed Size Master Link Assembly Type TAA 4	G80	TWN0810/4	73
Fixed Size Master Link Assembly Type TAB 1	G80	TWN0811/1	74
Fixed Size Master Link Assembly Type TAB 2	G80	TWN0811/2	74
Fixed Size Master Link Assembly Type TAB 4	G80	TWN0811/4	74
Fixed Size Shortening Device	G100	TWN1896	40
Hitches acc. to DIN 74054	G80	TWN0301	140
Hitches acc. to DIN 74054	G80	TWN0302	140
Hitches acc. to DIN 74054	G80	TWN0304	140

Index

Article	Grade	TWN No.	Page
Hitches acc. to DIN 74054	G80	TWN0308	.141
Hitches acc. to DIN 74054	G80	TWN0321	.141
Hitches acc. to DIN 74054	G80	TWN0323	.141
Identification Tag acc. To EN 12195-3	G80	TWN1402	.103+176
Identification Tag for Single and Multi Leg Sling Chain	G80	TWN0940	.101
Inspection Service			.211-212
Intermediate Master Link Type B	G100	TWN1795	.31
Intermediate Master Link Type B	G80	TWN0795	.71
Isolation Assembly	G80	TWN0893	.93
KE-Eye Bolt	G100	TWN1884	.124
Key Hook	G80	TWN0892	.93
Lashing Chain with Ratchet	G100	TWN1411	.45+182
Lashing Chain with Ratchet	G80	TWN1401	.95+176
Lashing Chain with Spindle Tensioner	G100	TWN1410	.44+182
Lashing Chain with Spindle Tensioner	G80	TWN1400	.95+176
Lashing Point with 2 welding brackets	G100	TWN1473	.133+187
Lashing Point, plugable with Intermediate Link		TWN1474	.189
Lashing Point, welding type, with spring	G100	TWN1880	.133+187
Latch Set for Eye Hooks and Swivel Hooks	G80	TWN0920-0922	.97
Lifting Hook for Engines	G80	TWN0889	.84
Lifting Point "compact", welding type, with spring	G100	TWN1882	.132
Lifting Point MDB	G80	TWN0127	.121
Lifting Point with 2 welding brackets	G100	TWN1872	.132
Lifting Point, double screw type, with intermediate link	G80	TWN0122	.120
Lifting Point, single screw type, with intermediate link	G80	TWN0123	.121
Lifting Point, welding type	G80	TWN0119	.130+180
Lifting Point, welding type, with spring	G80	TWN0124	.130+180
Load Pin for Clevis Type Hooks	G100	TWN1904/0	.46
Load Pin for Clevis Type Hooks	G80	TWN0904/0	.97
Load-Spirol Pins for Chain Coupling Shackles a. Chain Shackles	G80	TWN0905/0906	.97
Magnet Chain Slings	G80	TWN0601	.96
Master Link Assembly for 3- and 4-leg Chain Slings	G100	TWN1814	.30
Master Link Assembly for 3- and 4-leg Chain Slings	G80	TWN1314	.77
Master Link Assembly for 3- and 4-leg Rope Slings	G100	TWN1815	.31
Master Link Assembly for 3- and 4-leg Rope Slings	G80	TWN1315	.78
Master Link for Single Leg with Pin Coupling	G100	TWN1819	.34
Master Link for Single Leg with Pin Coupling	G80	TWN0820	.76
Master Link Form A	G100	TWN1813	.30
Oblong Master Link Type A	G80	TWN1313	.77
Offshore Master Link Assembly for 3- a. 4-Leg Wire Rope	G80	TWN0797	.71
Offshore Oblong Master Link Type A	G80	TWN0803	.72
Oversize Master Link Assy for 1-leg Slings suit. f.Crane Hooks	G80	TWN0815	.75
Oversize master link Assy for 2-leg Slings suit. f.Crane Hooks	G80	TWN0816	.75
Oversize Master Link Assy f. 3- a. 4-leg Slings suit. f. Crane Hooks	G80	TWN0817	.76
Pin Set for Clevis Self-Locking Hook	G100	TWN1933/0	.48
Pipe Transport Hook	G80	TWN0868	.83
Plate Hook for Basket Chain	G80	TWN0872	.83
Plate Hook for Basket Chain	G80	TWN0873	.83
RAPID-Shortening Claw®	G100	TWN1852	.39+186
Reduction Assembly	G80	TWN0875	.91
Ringshackle	G100	TWN1812	.44
Ringshackle	G80	TWN0812	.90
Rotating Lifting Point	G80	TWN0121/1	.120
Round Steel Chains acc. To ASTM 973 XL-200	G100	TWN0072	.29
Round Steel Chains acc. To PAS 1061 XL-400	G100	TWN1805	.28+183
Round Steel Chains for agricultural trailers and dung spreaders		TWN5100	.198
Round Steel Link Chains acc. to DIN763			.214



Index

Article	Grade	TWN No.	Page
Round Steel Link Chains acc. to DIN766-3			.214
Round Steel Link Chains acc. to EN818-2	.G80	TWN0805	.70+177
Rust & Acid Resistant Chains (1.4461)		TWN0084	.206
Rust & Acid Resistant Chains (1.4571/AISI316Ti)		TWN0083	.206
Rust & Acid Resistant Chains (1.4401,AISI316)		TWN0082	.206
S-Hook	.G80	TWN0860	.82
Safety Bolt Shackle Type C with, Nut and Cotter Pin	.G80	TWN0871	.87
Short Chain Tensioner	.G80	TWN1450	.89+178
Short Chain Tensioner with Ratchet	.G80	TWN1451	.89+178
Shortening Device for fixed size Master Link	.G80	TWN0896	.86
Skip Suspension Link	.G80	TWN0869	.91+181
Skip Suspension Link	.G100	TWN1869	.43+189
SOLIDO® Eye Sling Hook with Safety Latch	.G80	TWN0858/1	.82
Spare Part Bottom hook assy Part-No. 10N		TWN1018	.161
Spare Part Bottom hook assy Part-No. 8N		TWN1017	.160
Spare Part Friction plate Part-No. 16		TWN1011	.160
Spare Part Hitches acc. to DIN 74054		TWN1015	.160
Spare Part Ratchet disc Part-No. 17		TWN1010	.160
Spare Part Ratchet disc Part-No. 21N		TWN1012	.161
Spare Part Safety clip Part-No. 7N		TWN1013	.160
Spare Part Safety clip Part-No. 9N		TWN1014	.161
Spare Part Set for chain couplings Bolt Shackle and C-Shackle	.G80	TWN0930-0932	.98
Spare Part Set for THI-LOK®	.G80	TWN1920	.98
Spare Part Top hook assy Part-No. 8N		TWN1016	.161
Spare Parts for C-Shackles	.G100	TWN1930/0	.47
Spare Parts for Combi-Quick-Fastener	.G100	TWN1951	.49
Spare Parts for RAPID®- Shortening Claw	.G100	TWN1931/0	.48
Spare Parts for Shortening Hook	.G100	TWN1950	.49
Spare Parts for Shortening Hook	.G80	TWN0950-0952	.99
Spare Parts for Skip Suspension Link	.G100	TWN0968-0969	.50
Spare Parts for Skip Suspension Link	.G80	TWN0968-0969	.100
Spare Parts for Sling Hooks	.G100	TWN1908/0	.46
Spare Parts for Sling Hooks	.G80	TWN1908/5	.101
Spare Parts for XL-LOK®	.G100	TWN1921	.47
Spare Pin for Clevis Self-Locking Hooks	.G80	TWN0967/0	.99
Spare Set for Skip Suspension Link	.G80	TWN0962	.99
Special Connecting Link		TWN5200	.199
Special Coupling Bolt Shackle w. Safety Bolt, Nut a. Cotter Pin	.G80	TWN0897	.87
Special Flange		TWN5201	.200
Special Hammer Head-Screw		TWN5202	.200
Special Steel Link Chains			.215
Special-Drive-Pocket-Wheel		TWN5204	.200
Swivel	.G80	TWN0845	.90
Swivel Adapter	.G80	TWN0895	.94
Swivel Hook	.G80	TWN0887	.84
Swivel Hook with Safety Latch	.G80	TWN0854	.80
T-Handle Chain	.G80	TWN0894	.93
Tensioning Tag	.G100	TWN1402	.45+176
TITAN Lifting Point	.G100	TWN1120	.122
TM-Chain Block		TWN1000	.156
TM-Display			.159
TM-Girder Clamp		TWN0899	.159
TM-Lever Block		TWN1001	.155+190
Trigger Set for Self-Locking Hooks	.G100	TWN1935	.48
Trigger Set for Self-Locking Hooks	.G80	TWN0967/1	.100
X-TREME® Lifting Point	.G100	TWN1830	.123
XS-Lifting Point	.G100	TWN1890	.125
ZK-Module	.G80	TWN1471	.134+188



THIELE GmbH & Co. KG

Werkstr. 3 · D-58640 Iserlohn-Kalthof · Germany
Tel. +49 (0) 2371 947-0 · Fax +49 (0) 2371 947-241
www.thiele.de · lifting-technology@thiele.de

